



**Recommendation ITU-R M.2012-2**  
(09/2015)

**Detailed specifications of the terrestrial  
radio interfaces of International Mobile  
Telecommunications-Advanced  
(IMT-Advanced)**

**M Series**  
**Mobile, radiodetermination, amateur  
and related satellite services**

## Foreword

The role of the Radiocommunication Sector is to ensure the rational, equitable, efficient and economical use of the radio-frequency spectrum by all radiocommunication services, including satellite services, and carry out studies without limit of frequency range on the basis of which Recommendations are adopted.

The regulatory and policy functions of the Radiocommunication Sector are performed by World and Regional Radiocommunication Conferences and Radiocommunication Assemblies supported by Study Groups.

## Policy on Intellectual Property Right (IPR)

ITU-R policy on IPR is described in the Common Patent Policy for ITU-T/ITU-R/ISO/IEC referenced in Annex 1 of Resolution ITU-R 1. Forms to be used for the submission of patent statements and licensing declarations by patent holders are available from <http://www.itu.int/ITU-R/go/patents/en> where the Guidelines for Implementation of the Common Patent Policy for ITU-T/ITU-R/ISO/IEC and the ITU-R patent information database can also be found.

### Series of ITU-R Recommendations

(Also available online at <http://www.itu.int/publ/R-REC/en>)

Series	Title
<b>BO</b>	Satellite delivery
<b>BR</b>	Recording for production, archival and play-out; film for television
<b>BS</b>	Broadcasting service (sound)
<b>BT</b>	Broadcasting service (television)
<b>F</b>	Fixed service
<b>M</b>	<b>Mobile, radiodetermination, amateur and related satellite services</b>
<b>P</b>	Radiowave propagation
<b>RA</b>	Radio astronomy
<b>RS</b>	Remote sensing systems
<b>S</b>	Fixed-satellite service
<b>SA</b>	Space applications and meteorology
<b>SF</b>	Frequency sharing and coordination between fixed-satellite and fixed service systems
<b>SM</b>	Spectrum management
<b>SNG</b>	Satellite news gathering
<b>TF</b>	Time signals and frequency standards emissions
<b>V</b>	Vocabulary and related subjects

*Note: This ITU-R Recommendation was approved in English under the procedure detailed in Resolution ITU-R 1.*

Electronic Publication  
Geneva, 2015

© ITU 2015

All rights reserved. No part of this publication may be reproduced, by any means whatsoever, without written permission of ITU.

## RECOMMENDATION ITU-R M.2012-2

**Detailed specifications of the terrestrial radio interfaces of International Mobile Telecommunications-Advanced (IMT-Advanced)**

(2012-2014-2015)

**Scope**

This Recommendation identifies the terrestrial radio interface technologies of International Mobile Telecommunications-Advanced (IMT-Advanced) and provides the detailed radio interface specifications.

These radio interface specifications detail the features and parameters of IMT-Advanced. This Recommendation includes the capability to ensure worldwide compatibility, international roaming, and access to high-speed data services.

**Keywords**

IMT, IMT-Advanced, LTE-Advanced, WirelessMAN-Advanced, radio interface specifications

**Related ITU-R Recommendations, Reports and Resolutions**

Recommendation ITU-R M.1036	Frequency arrangements for implementation of the terrestrial component of International Mobile Telecommunications (IMT) in the bands identified for IMT in the Radio Regulations (RR)
Recommendation ITU-R M.1224	Vocabulary of Terms for International Mobile Telecommunications (IMT)
Recommendation ITU-R M.1579	Global circulation of IMT terrestrial terminals
Recommendation ITU-R M.1645	Framework and overall objectives of the future development of IMT-2000 and systems beyond IMT-2000
Recommendation ITU-R M.1822	Framework for services supported by IMT
Recommendation ITU-R M.2070	Generic unwanted emission characteristics of base stations using the terrestrial radio interfaces of IMT-Advanced
Recommendation ITU-R M.2071	Generic unwanted emission characteristics of mobile stations using the terrestrial radio interfaces of IMT-Advanced
Report ITU-R M.2038	Technology trends
Report ITU-R M.2072	World mobile telecommunication market forecast
Report ITU-R M.2074	Radio aspects for the terrestrial component of IMT-2000 and systems beyond IMT-2000
Report ITU-R M.2078	Estimated spectrum bandwidth requirements for the future development of IMT-2000 and IMT-Advanced
Report ITU-R M.2079	Technical and operational information for identifying spectrum for the terrestrial component of future development of IMT-2000 and IMT-Advanced
Report ITU-R M.2133	Requirements, evaluation criteria and submission templates for the development of IMT-Advanced
Report ITU-R M.2134	Requirements related to technical performance for IMT-Advanced radio interface(s)

Report ITU-R M.2135	Guidelines for evaluation of radio interface technologies for IMT-Advanced
Report ITU-R M.2198	The outcome of the evaluation, consensus building and decision of the IMT-Advanced process (steps 4-7), including characteristics of IMT-Advanced radio interfaces
Report ITU-R M.2320	Future technology trends of terrestrial IMT systems
Report ITU-R M.2334	Passive and active antenna systems for base stations of IMT systems
Resolution ITU-R 56-1	Naming for International Mobile Telecommunications
Resolution ITU-R 57-1	Principles for the process of development of IMT-Advanced

The ITU Radiocommunication Assembly,

*considering*

- a) that IMT systems are mobile broadband systems including both IMT-2000 and IMT-Advanced;
- b) that IMT-Advanced systems include the new capabilities of IMT that go beyond those of IMT-2000<sup>1</sup>;
- c) that such systems provide access to a wide range of telecommunication services including advanced mobile services, supported by mobile and fixed networks, which are increasingly packet-based;
- d) that IMT-Advanced systems support low to high mobility applications and a wide range of data rates in accordance with user and service demands in multiple user environments;
- e) that IMT-Advanced also has capabilities for high-quality multimedia applications within a wide range of services and platforms providing a significant improvement in performance and quality of service;
- f) that the key features of IMT-Advanced are:
  - a high degree of commonality of functionality worldwide while retaining the flexibility to support a wide range of services and applications in a cost-efficient manner;
  - compatibility of services within IMT and with fixed networks;
  - capability of interworking with other radio access systems;
  - high-quality mobile services;
  - user equipment suitable for worldwide use;
  - user-friendly applications, services and equipment;
  - worldwide roaming capability;

---

<sup>1</sup> Recommendations ITU-R M.1457 and ITU-R M.2012 are two separate, independent, and self-contained Recommendations, each one with a specific scope. Both Recommendations will evolve independently, and there could be some overlap reflected by commonality in content between the two documents.

- enhanced peak data rates to support advanced services and applications (100 Mbit/s for high and 1 Gbit/s for low mobility were established as targets for research)<sup>2</sup>;
- g) that these features enable IMT-Advanced to address evolving user needs;
- h) that the capabilities of IMT-Advanced systems are being continuously enhanced in line with technology developments;
- i) the necessity of priority services (e.g. emergency calls shall be supported as higher priority than other commercial services);
- j) that due to the large effective bandwidths required to support the very high data rates needed for the various services offered, allowances must be made for either much larger single carrier bandwidths (even as spectral efficiencies increase) or aggregation of RF carriers;
- k) that the rapid development of information technology, including the Internet, has resulted in the aggregation and convergence of various networks and digital devices,

*recognizing*

- a) that Resolution ITU-R 57-1 on the “Principles for the process of development of IMT-Advanced” outlines the essential criteria and principles used in the process of developing the Recommendations and Reports for IMT-Advanced, including Recommendation(s) for the radio interface specification,

*noting*

- a) that Report ITU-R M.2198 contains the outcome and conclusions of Steps 4 through 7 of the IMT-Advanced process, including the evaluation and consensus building, and provides the characteristics of the IMT-Advanced terrestrial radio interfaces for the first release of Recommendation ITU-R M.2012-0 (01-2012);
- b) that IMT-ADV/27 provides a summary of the information as requested in IMT-ADV/25 (Rev.1) Section 3 (“*Revision process in the case of existing IMT-Advanced technologies for Updates requiring a modification of the GCS or the DIS*”) for revision 1 of Recommendation ITU-R M.2012 (2014) and contains the conclusion on the acceptability of the proposed update,

*recommends*

- 1 that the terrestrial radio interfaces for IMT-Advanced should be:
  - “LTE-Advanced”<sup>3</sup>; and
  - “WirelessMAN-Advanced”<sup>4</sup>;
- 2 that the information provided or referenced in Annexes 1 and 2 should be used as the complete set of standards for the detailed specifications of the terrestrial radio interfaces of IMT-Advanced.

---

<sup>2</sup> Data rates sourced from Recommendation ITU-R M.1645.

<sup>3</sup> Developed by 3GPP as LTE Release 10 and Beyond (*Long Term Evolution-Advanced*).

<sup>4</sup> Developed by IEEE as the WirelessMAN-Advanced specification incorporated in IEEE Std 802.16 beginning with approval of IEEE Std 802.16m.

## Annex 1

### Specification of the LTE-Advanced<sup>5</sup> radio interface technology

#### Background

IMT-Advanced is a system with global development activity and the IMT-Advanced terrestrial radio interface specifications identified in this Recommendation have been developed by the ITU in collaboration with the *GCS*<sup>6</sup> *Proponents* and the *Transposing Organizations*. It is noted from Document IMT-ADV/24(Rev.2)<sup>7</sup>, that:

- The *GCS Proponent* must be one of the *RIT*<sup>8</sup>/*SRIT*<sup>9</sup> *Proponents* for the relevant technology, **and** must have legal authority to grant to ITU-R the relevant legal usage rights to the relevant specifications provided within a GCS corresponding to a technology in Recommendation ITU-R M.2012.
- A *Transposing Organization* must have been authorized by the relevant *GCS Proponent* to produce transposed standards for a particular technology, **and** must have the relevant legal usage rights.

It is further noted that *GCS Proponents* and *Transposing Organizations* must also qualify appropriately under the auspices of Resolution ITU-R 9-4 and the ITU-R “Guidelines for the contribution of material of other organizations to the work of the Study Groups and for inviting other organizations to take part in the study of specific matters (Resolution ITU-R 9-4)”.

The ITU has provided the global and overall framework and requirements, and has developed the Global Core Specification jointly with the *GCS Proponent*. The detailed standardization has been undertaken within the recognized *Transposing Organizations* which operate in concert with the *GCS Proponent*. This Recommendation therefore makes extensive use of references to externally developed specifications.

This approach was considered to be the most appropriate solution to enable completion of this Recommendation within the aggressive schedules set by the ITU and by the needs of administrations, operators and manufacturers.

This Recommendation has therefore been constructed to take full advantage of this method of work and to allow the global standardization time-scales to be maintained. The main body of this Recommendation has been developed by the ITU, with each Annex containing references pointing to the location of the more detailed information.

This Annex 1 contains the detailed information developed by the ITU and “ARIB, ATIS, CCSA, ETSI, TTA, and TTC on behalf of 3GPP” (the *GCS Proponent*) and ARIB, ATIS, CCSA, ETSI, TTA, and TTC (the *Transposing Organizations*).

Such use of referencing enables timely completion and update of the high-level elements of this Recommendation, with change control procedures, transposition, and public enquiry procedures

---

<sup>5</sup> Developed by 3GPP as LTE Release 10 and Beyond (*LTE-Advanced*).

<sup>6</sup> Global Core Specifications.

<sup>7</sup> Document [IMT-ADV/24\(Rev.2\)](#) is available on the ITU-R WP 5D webpage under the link “IMT-Advanced documents”.

<sup>8</sup> Radio Interface Technology.

<sup>9</sup> Set of Radio Interface Technologies.

being undertaken within the external organization. This information has generally been adopted unchanged, recognizing the need to minimize duplication of work, and the need to facilitate and support an ongoing maintenance and update process.

This general agreement, noting that the detailed information of the radio interface should to a large extent be achieved by reference to the work of external organizations, highlights not only the ITU's significant role as a catalyst in stimulating, coordinating and facilitating the development of advanced telecommunications technologies, but also its forward-looking and flexible approach to the development of this and other telecommunications standards for the 21<sup>st</sup> century.

A more detailed understanding of the process for the development of the first release of this Recommendation may be found in Document IMT-ADV/24(Rev.2) whereas details on the process for the development of revisions of this Recommendation may be found in Document IMT-ADV/25(Rev.1).

## **1.1 Overview of the radio interface technology**

### **1.1.1 Overview of the SRIT**

The IMT-Advanced terrestrial radio interface specifications known as *LTE-Advanced* and based on LTE Release 10 and Beyond are developed by 3GPP. In 3GPP terminology, the term E-UTRA (Evolved-UTRA) is also used to indicate the LTE radio interface.

*LTE-Advanced* is a Set of RITs (Radio Interface Technologies) consisting of one FDD RIT and one TDD RIT designed for operation in paired and unpaired spectrum, respectively. The TDD RIT is also known as TD-LTE Release 10 and Beyond or *TD-LTE-Advanced*. The two RITs have been jointly developed, providing a high degree of commonality while, at the same time, allowing for optimization of each RIT with respect to its specific spectrum/duplex arrangement.

Both the FDD RIT and the TDD RIT individually, and consequently the Set of RITs (SRIT), meet all the ITU IMT-Advanced minimum requirements in all four test environments defined in all aspects of Services, Spectrum and Technical performance. Furthermore, both the FDD RIT and TDD RIT individually, and consequently the SRIT, meet the requirements of Resolution ITU-R 57-1, *resolves 6 e) and f)* in all four test environments.

The complete set of standards for the terrestrial radio interface of IMT-Advanced identified as *LTE-Advanced* includes not only the key characteristics of IMT-Advanced but also the additional capabilities of *LTE-Advanced* both of which are continuing to be enhanced.

The radio aspects of *LTE-Advanced* also include the capabilities of LTE Release 8 and LTE Release 9. Information on the Radio specifications Release 8 and Release 9 is provided in § 1.2.2.1. Furthermore, information on system and core network specifications is also provided for a complete system perspective. These system and core network specifications address the network, terminal, and service aspects required to provide an integrated mobility solution including aspects such as user services, connectivity, interoperability, mobility and roaming, security, codecs and media, operations and maintenance, charging, etc. Information on the System and core network specifications Release 8, Release 9, Release 10, Release 11 and Release 12 is provided in § 1.2.2.2.

### **1.1.2 Overview of the Radio Interface Technology (RIT)**

#### **1.1.2.1 Overview of the FDD RIT**

The FDD RIT is the evolution of LTE FDD. The FDD RIT uses Frequency-Division Duplex operation and therefore is applicable for operation with paired spectrum. Both full-duplex and half-duplex FDD are supported.

### 1.1.2.2 Overview of the TDD RIT

The TDD RIT, also known as *TD-LTE-Advanced*, is the evolution of TD-LTE. The TDD RIT uses Time-Division Duplex operation and therefore is applicable for operation with unpaired spectrum. The TDD RIT provides flexibility in terms of downlink-uplink resource allocation by supporting multiple uplink-downlink resource-allocation configurations that can be used to match different traffic scenarios. The uplink-downlink resource-allocation configuration can be adapted to the varying instantaneous traffic and interference conditions even during operation.

It is also designed to exploit the more extensive channel reciprocity inherent in case of TDD operation, e.g. for beamforming, and facilitates coexistence with TD-SCDMA as well as other TDD-based IMT-2000 technologies.

### 1.1.3 Overview of the system aspects of the SRIT

The FDD and TDD RITs represent the evolution of the first releases of LTE FDD and TDD, respectively. The two RITs share many of the underlying structures to simplify implementation of dual-mode radio-access equipment. Transmission bandwidths up to 100 MHz are supported, yielding peak data rates up to roughly 4 Gbit/s in the downlink and 1.5 Gbit/s in the uplink.

The downlink transmission scheme is based on conventional OFDM to provide a high degree of robustness against channel frequency selectivity while still allowing for low-complexity receiver implementations also at very large bandwidths.

The uplink transmission scheme is based on Discrete Fourier Transform-spread OFDM (DFTS-OFDM). The use of DFTS-OFDM transmission for the uplink is motivated by the lower Peak-to-Average Power Ratio (PAPR) of the transmitted signal compared to conventional OFDM. This allows for more efficient usage of the power amplifier at the terminal, which translates into an increased coverage and/or reduced terminal power consumption. The uplink numerology is aligned with the downlink numerology.

Channel coding is based on rate-1/3 Turbo coding and is complemented by Hybrid-ARQ with soft combining to handle decoding errors at the receiver side. Data modulation supports QPSK, 16QAM, and 64QAM for both the downlink and the uplink. In downlink, 256QAM is supported.

The FDD and TDD RITs support bandwidths from approximately 1.4 MHz to 100 MHz. Carrier aggregation, i.e. the simultaneous transmission of multiple component carriers in parallel to/from the same terminal/eNB, is used to support bandwidths larger than 20 MHz. Component carriers do not have to be contiguous in frequency and can even be located in different frequency bands in order to enable exploitation of fragmented spectrum allocations by means of spectrum aggregation. Carrier Aggregation supports the functionality to aggregate TDD bands with different uplink and downlink allocations as well as the functionality to support multiple timing advancements. Carrier Aggregation also supports to aggregate FDD and TDD component carriers. Dual Connectivity allows aggregating component carriers of different eNBs that are connected via a non-ideal backhaul over the X2 interface.

Channel-dependent scheduling in both the time and frequency domains is supported for both downlink and uplink with the base-station scheduler being responsible for (dynamically) selecting the transmission resource as well as the data rate. The basic operation is dynamic scheduling, where the base-station scheduler takes a decision for each 1 ms Transmission Time Interval (TTI), but there is also a possibility for semi-persistent scheduling. Semi-persistent scheduling enables transmission resources and data rates to be semi-statically allocated to a given User Equipment (UE) for a longer time period than one TTI to reduce the control-signalling overhead. For better uplink coverage, TTI bundling allows UEs to transmit in four consecutive TTIs.



Multi-antenna transmission schemes are an integral part of both RITs. Multi-antenna precoding with dynamic rank adaptation supports both spatial multiplexing (single-user MIMO) and beam-forming. Spatial multiplexing with up to eight layers in the downlink and four layers in the uplink is supported. Multi-user MIMO, where multiple users are assigned the same time-frequency resources, is also supported. Coordinated MultiPoint (CoMP) operation is also supported, where multiple transmission points or reception points are coordinated in their transmission or reception respectively. The coordinated transmission points can belong to the same cell, to different cells of the same eNB or to different cells of different eNBs. A discovery reference signal can be used to identify transmission points or cells for CoMP and/or Carrier aggregation operation. Finally, transmit diversity based on Space-Frequency Block Coding (SFBC) or a combination of SFBC and Frequency Switched Transmit Diversity (FSTD) is supported.

Inter-cell interference coordination (ICIC), where neighbour cells exchange information aiding the scheduling in order to reduce interference, is supported for the RITs. ICIC can be used for homogenous deployments with non-overlapping cells of similar transmission power, as well as for heterogeneous deployments where a higher-power cell overlays one or several lower-power nodes. In order to increase the potential of cell range expansion, functionality for terminal-side interference mitigation of reference and synchronization signals as well as the broadcast channel exists. A terminal-side mitigation of inter-cell interference caused by the data channel is supported with network assistance. A network-side interference mitigation technique is supported, which is based on the ability to turn on and off secondary cells.

Relaying functionality is included in both the FDD and TDD RITs. The relay node appears as a conventional base station (e-Node B) to terminals but is wirelessly backhauled to the remaining part of the radio-access network using the LTE Release 10 radio-interface technology.

Both RITs support various types of machine-type communication. In order to better address the low-cost segment, a low-complexity terminal (Category 0) is supported, which has approximately 50% reduced modem complexity as compared to the least complex 'normal' UE (Category 1). In order to improve UE power consumption, a Power Saving Mode exists, in which a terminal can minimize its ON times.

In order to enhance data offloading, both RITs support LTE/Wi-Fi interworking functionality. Based on configurable rules, the UE steers its data traffic to the most appropriate radio access.

From Rel-12 onwards, sidelink transmissions are defined for Proximity based Services (ProSe) Direct Discovery and ProSe Direct Communication between terminals. ProSe Direct Communication is targeting only Public Safety applications and allows terminals to communicate with each other directly without routing the data via the eNB. ProSe Direct Discovery allows discovering other terminals in close proximity. Direct communication is also supported when a terminal is out of LTE coverage.

### 1.1.3.1 Network architecture

The *LTE-Advanced* radio-access network has a flat architecture with a single type of node, the *eNodeB*, which is responsible for all radio-related functions in one or several cells. The *eNodeB* is connected to the core network by means of the S1 interface, more specifically to the *serving gateway* (S-GW) by means of the user-plane part, S1-u, and to the *Mobility Management Entity* (MME) by means of the control-plane part, S1-c. One *eNodeB* can interface to multiple MMEs/S-GWs for the purpose of load sharing and redundancy.

The X2 interface, connecting *eNodeBs* to each other, is mainly used to support active-mode mobility. This interface may also be used for multi-cell *Radio Resource Management* (RRM) functions such

as ICIC or CoMP. The X2 interface is also used to support lossless mobility between neighbouring cells by means of packet forwarding.

FIGURE 1.1  
Radio-access network interfaces

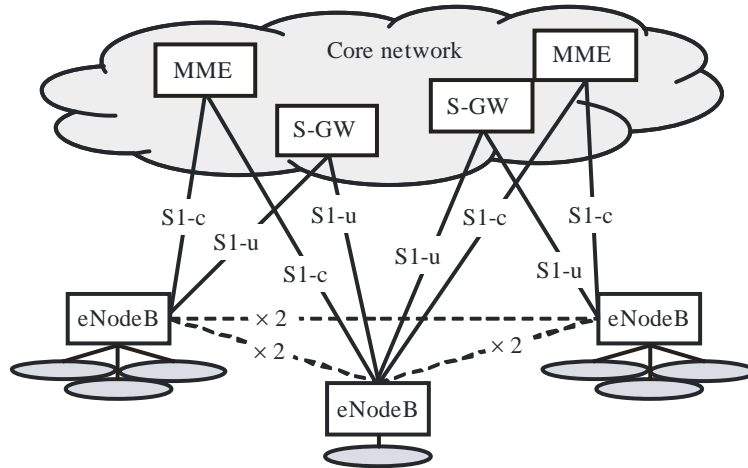

5-275-01-01

1.1.3.2 Layer 2 protocol architecture

Layer 2 (L2) consists of several sub-layers: *Packet Data Convergence Protocol (PDCP)*, *Radio Link Control (RLC)* and *Medium Access Control (MAC)*. The downlink and uplink protocol structures are illustrated in Fig. 1.2 and Fig. 1.3, respectively. Layer 2 provides one or more Radio Bearers to higher layers to which IP packets are mapped according to their Quality-of-Service (QoS) requirements. L2/MAC PDUs, also referred to as transport blocks, are created according to instantaneous scheduling decisions and delivered to the physical layer on one or several transport channels (one transport channel of the same type per component carrier).

FIGURE 1.2  
Downlink L2 protocol structure

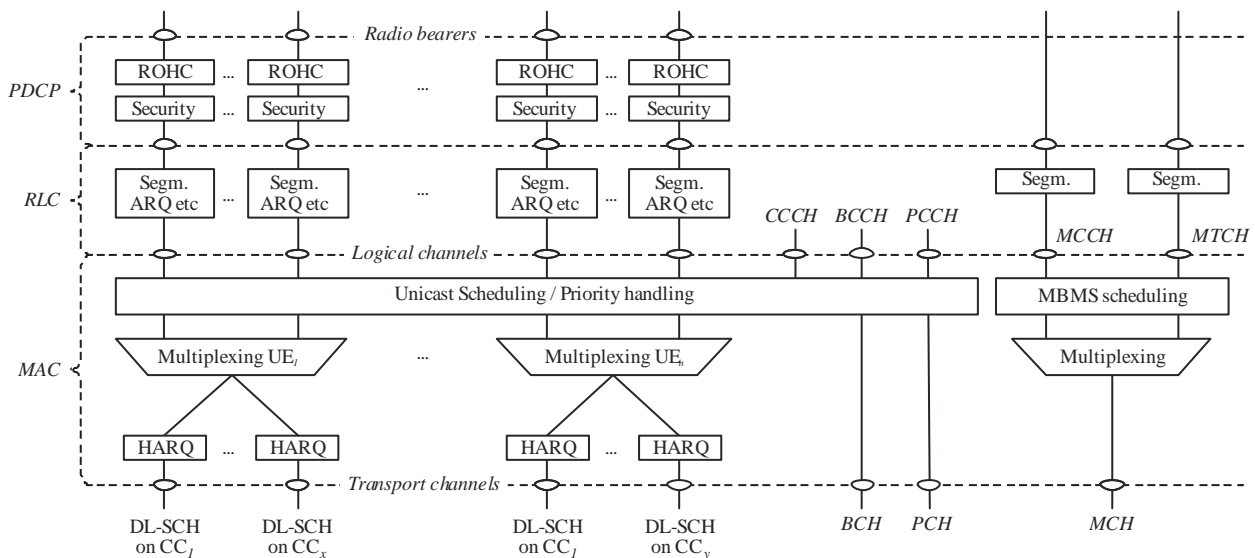

5-275-01-02

FIGURE 1.3

## Uplink L2 protocol structure

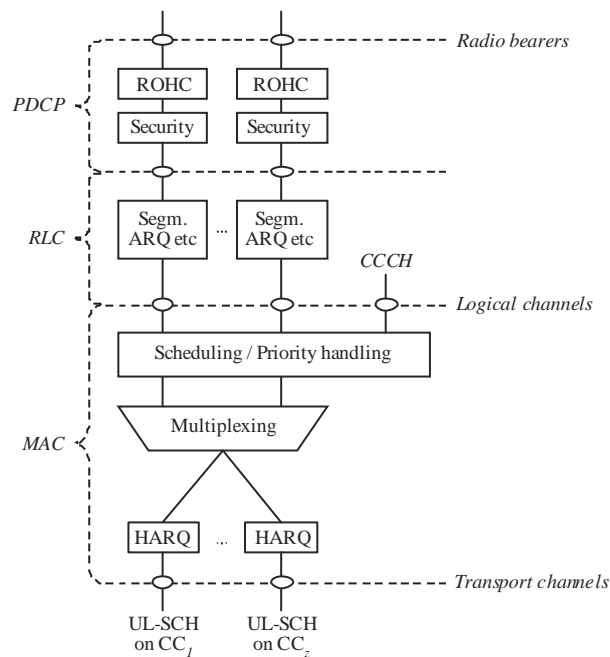

5-275-01-03

In Dual Connectivity, a data radio bearer can be configured as Master Cell Group (MCG) bearer, Secondary Cell Group (SCG) bearer or a split bearer. The MCG bearer is served by the Master eNB (MeNB), SCG bearer by the Secondary eNB (SeNB) and the split bearer is served by both eNBs. For a split bearer, a common PDCP entity is located in the MeNB, but there are two RLC entities, one terminating in the MeNB and one in the SeNB.

### 1.1.3.2.1 Packet Data Convergence Protocol (PDCP)

*Packet Data Convergence Protocol (PDCP)* is responsible for:

- User plane:
  - Header compression and decompression of IP data flows using ROHC.
  - Transfer of user data.
  - Maintenance of PDCP Sequence Numbers (SNs).
  - In-sequence delivery of upper layer PDUs at PDCP re-establishment procedure for RLC AM.
  - For split bearers in Dual Connectivity (only support for RLC AM): PDCP PDU routing for transmission and PDCP PDU reordering for reception.
  - Duplicate detection of lower layer SDUs at PDCP re-establishment procedure for RLC AM.
  - Retransmission of PDCP SDUs at handover for RLC AM.
  - Ciphering and deciphering.
  - Timer-based SDU discard in uplink.
- Control plane:
  - Maintenance of PDCP Sequence Numbers (SNs).
  - Ciphering and Integrity Protection and Verification.

- Transfer of control plane data.

PDCP uses the services provided by the RLC sub-layer. There is one PDCP entity per radio bearer configured for a UE.

### 1.1.3.2.2 Radio Link Control (RLC)

*Radio Link Control (RLC)* is responsible for:

- Transfer of upper layer PDUs.
- Error correction through ARQ (only for AM data transfer).
- Concatenation, segmentation and reassembly of RLC SDUs (only for UM and AM data transfer).
- Resegmentation of RLC data PDUs (only for AM data transfer).
- Reordering of RLC data PDUs (only for UM and AM data transfer).
- Duplicate detection (only for UM and AM data transfer).
- Protocol error detection (only for AM data transfer).
- RLC SDU discard (only for UM and AM data transfer).
- RLC re-establishment.

Depending on the mode-of-operation, an RLC entity may provide all, a subset of, or none of the services above. The RLC can operate in three different modes:

- *Transparent mode (TM)*, where the RLC is completely transparent and is in essence bypassed. This configuration is used for control-plane broadcast channels such as Broadcast Control Channel (BCCH), Common Control Channel (CCCH) and Paging Control Channel (PCCH) only where the information should reach multiple users.
- *Unacknowledged mode (UM)*, where the RLC provides all the functionality above except error correction, is used when error-free delivery is not required, for example for Multicast Control Channel (MCCH) and Multicast Traffic Channel (MTCH) using Multimedia Broadcast over a Single Frequency Network (MBSFN) and for Voice-over-IP (VoIP).
- *Acknowledged mode (AM)*, where the RLC provides all the services above, is the main mode-of-operation for TCP/IP packet data transmission on the Downlink Shared Channel (DL-SCH). Segmentation/reassembly, in-sequence delivery and retransmissions of erroneous data are all supported.

The RLC offers services to the PDCP in the form of *radio bearers* and uses services from the MAC layer in the form of *logical channels*. There is one RLC entity per radio bearer configured for a terminal.

### 1.1.3.2.3 Medium access control (MAC)

The MAC layer is responsible for:

- Mapping between logical channels and transport channels.
- Multiplexing/demultiplexing of MAC SDUs belonging to one or different logical channels into/from transport blocks delivered to/from the physical layer on transport channels.
- Scheduling information reporting.
- Error correction through N-process stop-and-wait hybrid-ARQ (HARQ) with synchronous (for the uplink) and asynchronous (for the downlink) retransmissions.
- Priority handling between logical channels of one UE.

- Priority handling between UEs by means of dynamic scheduling.
- Logical Channel prioritization.
- Multimedia Broadcast/Multicast Service (MBMS) identification.
- Transport format selection.
- Padding.

The ProSe specific services and functions of the MAC sublayer include:

- Radio resource selection;
- Packet filtering for Prose Direct Communication.

In case of Dual Connectivity, the UE is configured with two independent MAC entities, one for MCG and one for SCG. The MAC offers services to the RLC in the form of *logical channels*. A logical channel is defined by the *type* of information it carries and is generally classified as a *control channel*, used for transmission of control and configuration information necessary for operating an *LTE-Advanced* system, or as a *traffic channel*, used for the user data. The set of logical-channel types specified for *LTE-Advanced* includes:

- *Broadcast Control Channel* (BCCH), used for broadcasting system control information.
- *Paging Control Channel* (PCCH), a downlink channel used for paging when the network is not aware of the location of the UE and for system information change notifications.
- *Common Control Channel* (CCCH), used for transmission of control information between UEs and network when the UE has no RRC connection.
- *Dedicated Control Channel* (DCCH), used for transmission of control information to/from a mobile terminal when the UE has a RRC connection.
- *Multicast Control Channel* (MCCH), used for transmission of control information required for reception of the MTCH.
- *Sidelink Broadcast Channel* (SBCH) used for broadcasting sidelink system information from one UE to other UE(s). This channel is used only by ProSe Direct Communication capable UEs.
- *Dedicated Traffic Channel* (DTCH), used for transmission of user data to/from a mobile terminal. This is the logical channel type used for transmission of all uplink and non-MBSFN downlink user data.
- *Multicast Traffic Channel* (MTCH), used for downlink transmission of MBMS services.
- *Sidelink Traffic Channel* (STCH) is a point-to-multipoint channel, for transfer of user information from one UE to other UEs. This channel is used only by Prose Direct Communication capable UEs.

From the physical layer, the MAC layer uses services in the form of *Transport Channels*. A transport channel is defined by *how* and *with what characteristics* the information is transmitted over the radio interface. Data on a transport channel is organized into *transport blocks*. In each *Transmission Time Interval* (TTI), at most one or two (in case of spatial multiplexing) transport blocks are transmitted per component carrier.

Associated with each transport block is a *Transport Format* (TF), specifying *how* the transport block is to be transmitted over the radio interface. The transport format includes information about the transport-block size, the modulation scheme, and the antenna mapping. The scheduler is responsible for (dynamically) determining the uplink as well as downlink transport format in each TTI.

The following transport-channel types are defined:

- *Broadcast Channel* (BCH) has a fixed transport format, provided by the specifications. It is used for transmission of parts of the BCCH system information, more specifically the so-called *Master Information Block* (MIB).
- *Paging Channel* (PCH) is used for transmission of paging information from the PCCH logical channel. The PCH supports *discontinuous reception* (DRX) to allow the mobile terminal to save battery power by waking up to receive the PCH only at predefined time instants.
- *Downlink Shared Channel* (DL-SCH) is the main transport-channel type used for transmission of downlink data in *LTE-Advanced*. It supports dynamic rate adaptation and channel-dependent scheduling, hybrid-ARQ with soft combining, and spatial multiplexing. It also supports DRX to reduce mobile-terminal power consumption while still providing an always-on experience.

The DL-SCH is also used for transmission of the parts of the BCCH system information not mapped to the BCH. In case of transmission to a terminal using multiple component carriers the UE receives one DL-SCH per component carrier.

- *Multicast Channel* (MCH) is used to support MBMS. It is characterized by a semi-static transport format and semi-persistent scheduling. In case of multi-cell transmission using MBSFN, the scheduling and transport format configuration is coordinated among the cells involved in the MBSFN transmission.
- *Uplink Shared Channel* (UL-SCH) is the uplink counterpart to the DL-SCH, i.e. it is the uplink transport channel used for transmission of uplink data.
- *Random Access Channel* (RACH) is also defined as an uplink transport channel although it does not carry transport blocks. The RACH is used in the uplink to respond to the paging message or to initiate the move to the RRC\_CONNECTED state according to terminal data transmission needs.
- *Sidelink broadcast channel* (SL-BCH) uses a pre-defined transport format.
- *Sidelink discovery channel* (SL-DCH) supports both UE autonomous resource selection and scheduled resource allocation by eNodeB; it uses a fixed size, pre-defined format periodic broadcast transmission.
- *Sidelink shared channel* (SL-SCH) supports both UE autonomous resource selection and scheduled resource allocation by eNodeB; it supports HARQ combining and dynamic link adaptation by varying the transmit power, modulation and coding.

The mapping between logical channels, transport channels and physical channels (described in § 1.1.3.3) is illustrated in Fig. 1.4 for the downlink, Fig. 1.5 for the uplink and Fig. 1.6 for the sidelink.

FIGURE 1.4

**Downlink channel mapping**

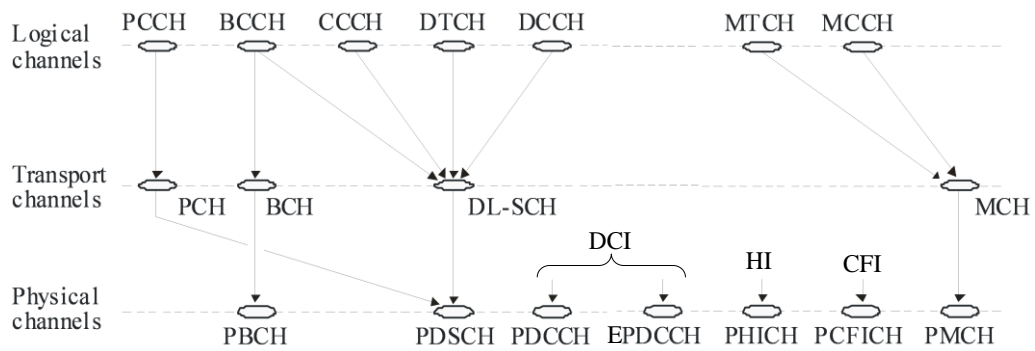

5-275-01-04

FIGURE 1.5

**Uplink channel mapping**

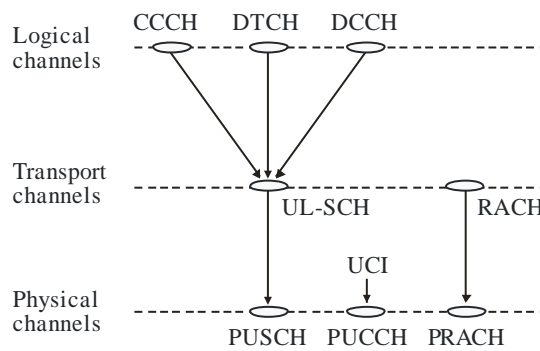

5-275-01-05

FIGURE 1.6

**Sidelink channel mapping**

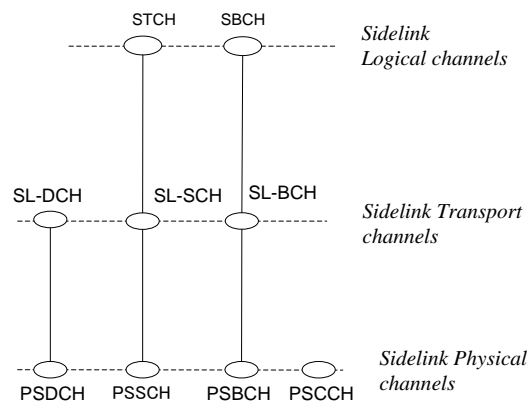

**1.1.3.3 Physical layer**

The physical layer is responsible for:

- Modulation and demodulation of physical channels.

- Error detection on the transport channel and indication to higher layers.
- Forward Error Correction (FEC) encoding and decoding of transport channels.
- Rate matching of the coded transport channel to physical channels.
- Mapping of the coded transport channel onto physical channels according to Fig. 1.4 (downlink) and Fig. 1.5 (uplink).
- Hybrid ARQ soft-combining.
- Frequency and time synchronization.
- Power weighting of physical channels.
- Multi-antenna processing and beamforming.
- Characteristic measurements and indication to higher layers.
- RF processing.

A simplified overview of the processing for the DL-SCH is given in Fig. 1.7.

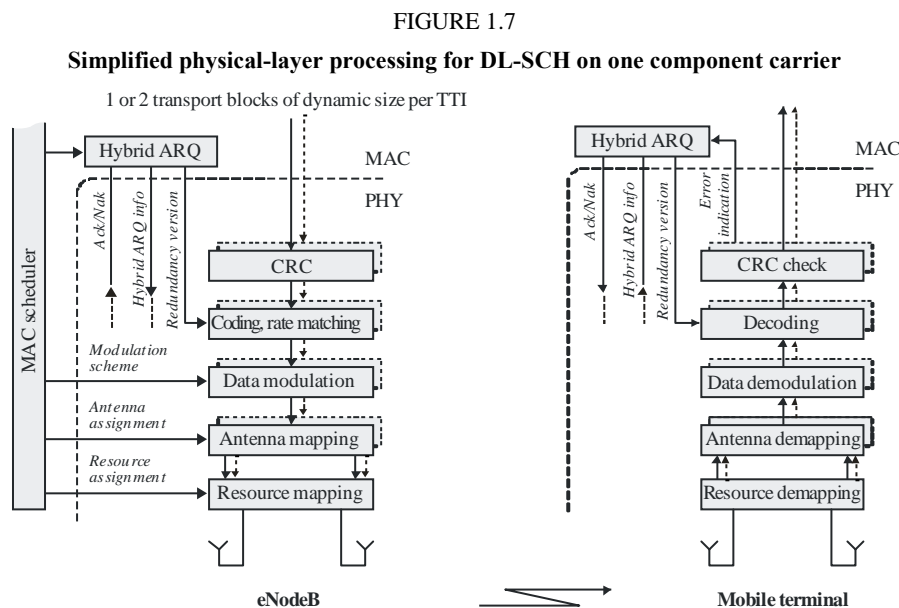

### 1.1.3.3.1 Physical channels

The following different types of physical channels are defined for the downlink:

- Physical Downlink Shared Channel (PDSCH): Used for transmission of user and control plane data services.
- Physical Multicast Channel (PMCH): Used for transmission of control and user-plane broadcast services during MBSFN subframes.
- Physical Downlink Control Channel (PDCCH): Used for transmission of control information such as resource allocation, transport format and HARQ related information.
- Enhanced Physical Downlink Control Channel (EPDCCH): Used for transmission of control information such as resource allocation, transport format and HARQ related information.
- Physical Broadcast Channel (PBCH): Used for conveying cell and/or system specific information.



- Physical Control Format Indicator Channel (PCFICH): It indicates to the UE the control format (number of symbols comprising PDCCH, PHICH) of the current subframe.
- Physical Hybrid ARQ Indicator Channel (PHICH): It conveys the ACK/NAK information for UL (PUSCH) transmissions received at the eNodeB.

Three different types of physical channels are defined for the uplink:

- Physical Random Access Channel (PRACH): It conveys a preamble which is used to trigger a random-access procedure in the eNodeB.
- Physical Uplink Shared Channel (PUSCH): It conveys both user data and upper layer control information.
- Physical Uplink Control Channel (PUCCH): It conveys control information (scheduling requests, CQI, PMI, RI, HARQ ACK/NAK for PDSCH, etc.).

The following types of physical channels are defined for the sidelink:

- Physical sidelink broadcast channel (PSBCH): Carries system and synchronization related information, transmitted from the UE.
- Physical sidelink discovery channel (PSDCH): Carries ProSe Direct Discovery message from the UE.
- Physical sidelink control channel (PSCCH): Carries control from a UE for ProSe Direct Communication.
- Physical sidelink shared channel (PSSCH): Carries data from a UE for ProSe Direct Communication.

### 1.1.3.3.2 Time-domain structure and duplex schemes

Figure 1.8 illustrates the high-level time-domain structure for transmission, with each (*radio*) *frame* of length 10 ms consisting of ten equally sized *subframes* of length 1 ms. Each subframe consists of two equally sized *slots* of length  $T_{slot} = 0.5$  ms with each slot consisting of a number of OFDM symbols including cyclic prefix.

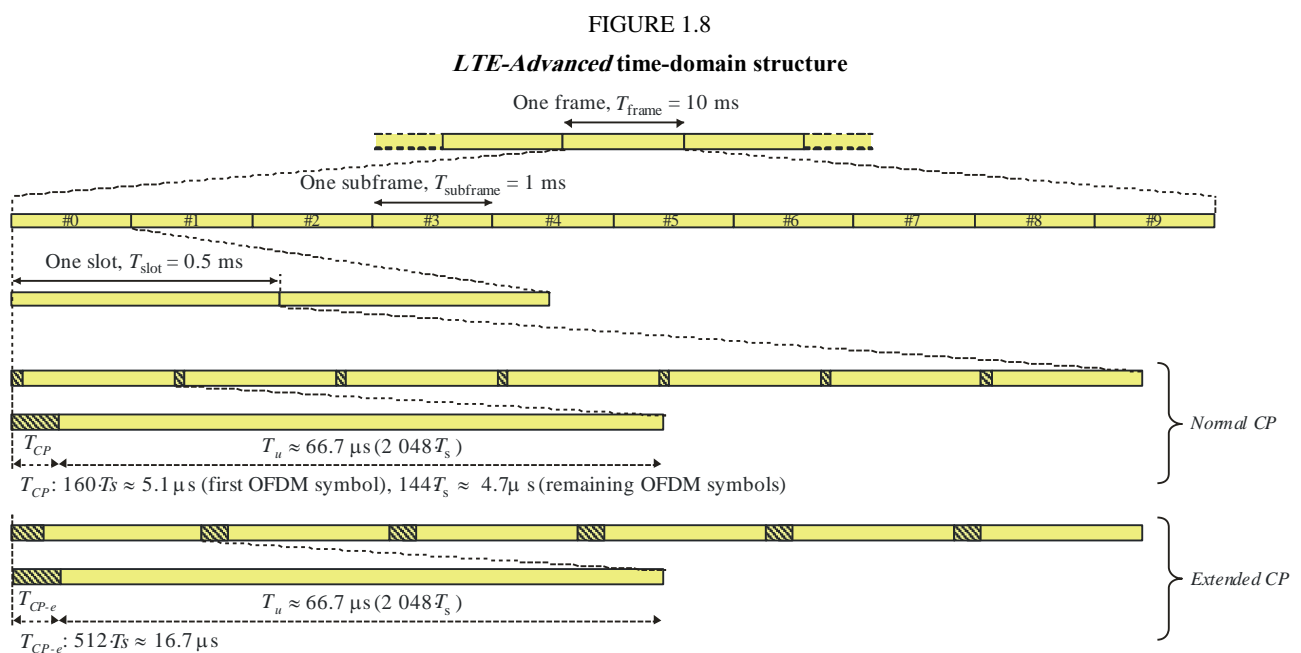

*LTE-Advanced* can operate in both FDD and TDD as illustrated in Fig. 1.9. Although the time-domain structure is, in most respects, the same for FDD and TDD there are some differences between the two duplex modes, most notably the presence of a *special subframe* in case of TDD. The special subframe is used to provide the necessary guard time for downlink-to-uplink switching.

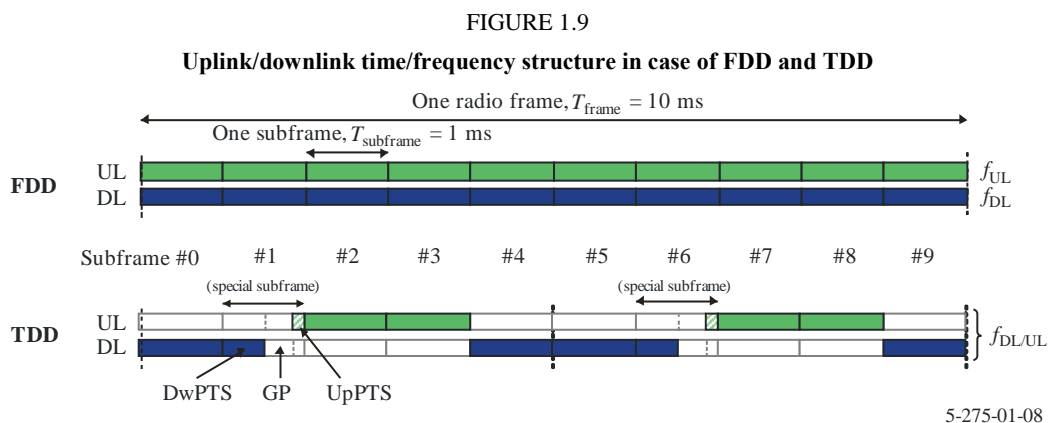

In case of FDD operation (upper part of Fig. 1.9), there are two carrier frequencies for each component carrier, one for uplink transmission ( $f_{UL}$ ) and one for downlink transmission ( $f_{DL}$ ). During each frame, there are thus ten uplink subframes and ten downlink subframes and uplink and downlink transmission can occur simultaneously within a cell. Half-duplex operation at the UE side is supported by the scheduler ensuring non-simultaneous reception and transmission at the UE.

In case of TDD operation (lower part of Fig. 1.9), there is only a single carrier frequency per component carrier and uplink and downlink transmissions are always separated in time also on a cell basis. As seen in the figure, some subframes are allocated for uplink transmissions and some subframes for downlink transmission with the switch between downlink and uplink occurring in the *special subframe*. The special subframe is split into three parts: a downlink part (DwPTS), a guard period (GP) where the switch occurs, and an uplink part (UpPTS). The DwPTS is in essence treated as a normal downlink subframe, although the amount of data that it is possible to transmit is smaller due to the reduced length of the DwPTS. The UpPTS can be used for channel sounding or random access. The DwPTS, GP, and UpPTS have configurable individual lengths to support different deployment scenarios, and a total length of 1 ms.

Different asymmetries in terms of the amount of resources allocated for uplink and downlink transmission, respectively, are provided through seven different downlink/uplink configurations as shown in Fig. 1.10. In case of carrier aggregation, the downlink/uplink configuration is identical across component carriers in the same band and may be the same or different across component carriers in different bands.

Coexistence between the TDD RIT and other (IMT-2000) TDD systems such as TD-SCDMA is catered for by aligning the switch points between the two systems and selecting the appropriate special subframe configuration and uplink-downlink asymmetry.

FIGURE 1.10

## Uplink-downlink asymmetries supported by the TDD RIT

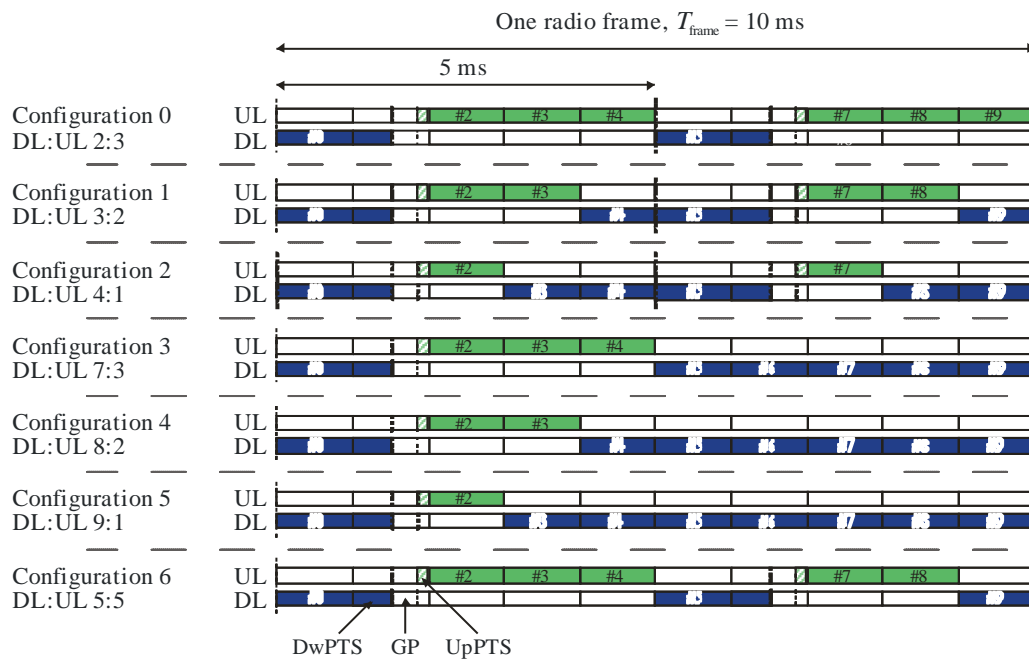

5-275-01-09

Sidelink transmissions use the same frame structure as the frame structure that is defined for uplink and downlink when UEs are in network coverage. However, the sidelink transmissions are restricted to a sub-set of the uplink resources in time and frequency domain.

The physical channel structure is similar to uplink transmissions and the same basic transmission scheme as the UL transmission scheme is used. However, sidelink is limited to single cluster transmissions and it uses a 1 symbol gap at the end of each sidelink subframe.

### 1.1.3.3.3 Physical layer processing

To the transport block(s) to be transmitted on a DL-SCH or UL-SCH, a CRC is attached, followed by rate-1/3 Turbo coding for error correction. Rate matching is used not only to match the number of coded bits to the amount of resources allocated for the DL-SCH/UL-SCH transmission, but also to generate the different redundancy versions as controlled by the hybrid-ARQ protocol. In case of spatial multiplexing, the processing is duplicated for the two transport blocks. After rate matching, the coded bits are modulated (QPSK, 16QAM, 64QAM, 256QAM in DL). In case of multi-antenna transmission, the modulation symbols are mapped to multiple layers and precoded before being mapped to the different antenna ports. Alternatively, transmit diversity can be applied. Finally, the (precoded) modulation symbols are mapped to the time-frequency resources allocated for the transmission.

Downlink transmission is based on conventional OFDM with a cyclic prefix. The subcarrier spacing is  $\Delta f = 15$  kHz and two cyclic prefix lengths are supported: normal cyclic prefix  $\approx 4.7$   $\mu$ s and extended cyclic prefix  $\approx 16.7$   $\mu$ s. In the frequency domain, the number of resource blocks can range from 6 to 100 per component carrier (for channel bandwidths ranging from 1.4 to 20 MHz respectively), where a resource block is 180 kHz in the frequency domain. There can be up to five component carriers transmitted in parallel implying an overall bandwidth up to 100 MHz.

Uplink transmission is based on DFT-spread OFDM (DFTS-OFDM). DFTS-OFDM can be seen as a DFT precoder, followed by conventional OFDM with the same numerology as in the downlink.

Multiple DFT precoding sizes, corresponding to transmission with different scheduled bandwidths, can be used.

The remaining downlink transport channels (PCH, BCH, MCH) are based on the same general physical-layer processing as DL-SCH, although with some restrictions in the set of features used.

#### **1.1.3.3.4 Multi-antenna transmission**

A wide range of multi-antenna transmission schemes are supported in the downlink:

- Single-antenna transmission using a single cell-specific reference signal.
- Closed-loop spatial multiplexing, also known as codebook-based beam-forming or precoding, of up to four layers using cell-specific reference signals. Feedback reports from the terminal are used to assist the eNodeB in selecting a suitable precoding matrix.
- Open-loop spatial multiplexing, also known as large-delay cyclic delay diversity, of up to four layers using cell-specific reference signals.
- Spatial multiplexing of up to eight layers using UE-specific reference signals. The eNodeB may use feedback reports or exploit channel reciprocity to set the beam-forming weights.
- Transmit diversity based on space-frequency block coding (SFBC) or a combination of SFBC and Frequency Switched Transmit Diversity (FSTD).
- Multi-user MIMO where multiple terminals are assigned overlapping time-frequency resources.
- Downlink Coordinated MultiPoint (DL-CoMP) operation where multiple transmission points are coordinated.

The following multi-antenna transmission schemes are supported in the uplink:

- Single-antenna transmission.
- Precoding supporting rank-adaptive spatial multiplexing with one up to four layers.
- Uplink Coordinated MultiPoint (UL-CoMP) operation where multiple reception points are coordinated.

#### **1.1.3.3.5 Link adaptation and power control**

According to the radio channel conditions, the Modulation and Coding Scheme (MCS) can be adapted flexibly. The same modulation and coding is applied to all resource units assigned to the same transport block within a TTI. Uplink power control determines the average power over a DFTS-OFDM symbol in which the physical channel is transmitted.

#### **1.1.3.3.6 L1/L2 control signalling**

Downlink control information (DCI) is transmitted on either a PDCCH or an EPDCCH.

The PDCCH is transmitted in the first one to three OFDM symbols of each downlink subframe in each component carrier with the number of OFDM symbols being indicated on the PCFICH. Downlink and uplink scheduling grants (consisting of UE identity, time-frequency resources and transport format) and hybrid-ARQ acknowledgements are transmitted on the PDCCH and PHICH, respectively. Each grant is transmitted on a separate PDCCH using QPSK modulation and cell-specific reference signals.

The EPDCCH is transmitted in pairs of Physical Resource Blocks (PRBs) multiplexed in frequency with the PDSCH; it carries downlink and uplink scheduling grants (consisting of UE identity, time-frequency resources and transport format). The EPDCCH uses QPSK modulation and

demodulation reference signals, and it may use either frequency-localized or frequency-distributed transmission.

Sidelink resource allocation can be transmitted on the PDCCH/EPDCCH.

Uplink control information (UCI), consisting of channel-state information (CSI), scheduling requests and hybrid-ARQ acknowledgements, is transmitted at the band edges of the primary uplink component carrier. Alternatively, parts of the control signalling can be multiplexed with data on PUSCH. To support downlink CoMP transmission, a UE may be configured with multiple CSI processes.

#### 1.1.3.3.7 MBSFN operation

Multicast/Broadcast over Single Frequency Network (MBSFN) transmission, where the same signal is transmitted from multiple, time-synchronized cells, is supported by the MCH transport channel. One component carrier can support simultaneous unicast and broadcast support through time-domain multiplexing of MCH and DL-SCH transmissions.

## 1.2 Detailed specification of the radio interface technology

Detailed specifications described in this Annex are developed around a “Global Core Specification” (GCS)<sup>10</sup>, which is related to externally developed materials incorporated by specific references for a specific technology. The process and use of the GCS, references, and related notifications and certifications are found as Document IMT-ADV/24(Rev.2).

The IMT-Advanced standards contained in this section are derived from the global core specification for *LTE-Advanced* contained at <http://ties.itu.int/u/itu-r/ede/rsg5/IMT-Advanced/GCS/M.2012-2/LTE-Advanced/>. The following notes apply to the sections below:

- 1) The identified *Transposing Organizations*<sup>11</sup> should make their reference material available from their website.
- 2) This information was supplied by the *Transposing Organizations* and relates to their own deliverables of the transposed global core specification.

Section 1.2.1 contains titles and synopses of the Global Core Specification of IMT-Advanced radio interface technology entitled *LTE-Advanced* and the related hyperlinks to the transposed standards. Specifications listed in § 1.2.2 are not part of the *LTE-Advanced* GCS.

---

<sup>10</sup> A “GCS” (Global Core Specification) is the set of specifications that defines a single RIT, an SRIT, or a RIT within an SRIT.

<sup>11</sup> The following identified Transposing Organizations have provided their transposed sets of standards information contained in this section:

- Association of Radio Industries and Businesses (ARIB)
- Alliance for Telecommunications Industry Solutions (ATIS)
- China Communications Standards Association (CCSA)
- European Telecommunications Standards Institute (ETSI)
- Telecommunications Technology Association (TTA)
- Telecommunication Technology Committee (TTC).

The specific 3GPP specifications of the GCS for *LTE-Advanced* that are being transposed in § 1.2.1 are summarized in Table 1.1:

TABLE 1.1  
3GPP specifications in § 1.2.1 that are to be transposed

36.100 Series	36.200 Series	36.300 Series	36.400 Series	36.500 series	37.xxx Series	25.400 Series
TS 36.101	TS 36.201	TS 36.300	TS 36.401	TS 36.508	TS 37.104	TS 25.460
TS 36.104	TS 36.211	TS 36.302	TS 36.410	TS 36.509	TS 37.113	TS 25.461
TS 36.106	TS 36.212	TS 36.304	TS 36.411	TS 36.521-1	TS 37.141	TS 25.462
TS 36.111	TS 36.213	TS 36.305	TS 36.412	TS 36.521-2	TS 37.320	TS 25.466
TS 36.112	TS 36.214	TS 36.306	TS 36.413	TS 36.521-3	TS 37.571-1	
TS 36.113	TS 36.216	TS 36.307	TS 36.414	TS 36.523-1	TS 37.571-2	
TS 36.116		TS 36.314	TS 36.420	TS 36.523-2	TS 37.571-3	
TS 36.117		TS 36.321	TS 36.421	TS 36.523-3	TS 37.571-4	
TS 36.124		TS 36.322	TS 36.422		TS 37.571-5	
TS 36.133		TS 36.323	TS 36.423			
TS 36.141		TS 36.331	TS 36.424			
TS 36.143		TS 36.355	TS 36.425			
TS 36.171			TS 36.440			
			TS 36.441			
			TS 36.442			
			TS 36.443			
			TS 36.444			
			TS 36.445			
			TS 36.455			
			TS 36.456			
			TS 36.457			
			TS 36.458			
			TS 36.459			

## 1.2.1 Titles and synopses of the global core specification and the transposed standards

### 1.2.1.1 Introduction

The standards documents referenced below, as transposed from the relevant 3GPP specifications, are provided by the identified *Transposing Organizations* as the transposed sets of standards for the terrestrial radio interface of IMT-Advanced identified as *LTE-Advanced* and includes not only the key characteristics of IMT-Advanced but also the additional capabilities of *LTE-Advanced* both of which are continuing to be enhanced.

### 1.2.1.2 Radio Layer 1

#### 1.2.1.2.1 TS 36.201

#### Evolved Universal Terrestrial Radio Access (E-UTRA); LTE physical layer; General description

This document provides a general description of the physical layer of the E-UTRA radio interface. This document also describes the document structure of the 3GPP E-UTRA physical layer specifications, i.e. TS 36.200 series. The TS 36.200 series specifies the Uu point for the LTE mobile system, and defines the minimum level of specifications required for basic connections in terms of mutual connectivity and compatibility.

SDO (2)	Document No.	Version	Issued date	Location (1)
<b>Release 10</b>				
ARIB	ARIB STD-T104-36.201		10.0.0 Sep 11	<a href="http://www.arib.or.jp/english/html/overview/doc/STD-T104v1_00/2_T104/ARIB-STD-T104/Rel10/36/A36201-a00.pdf">http://www.arib.or.jp/english/html/overview/doc/STD-T104v1_00/2_T104/ARIB-STD-T104/Rel10/36/A36201-a00.pdf</a>
ATIS	ATIS.3GPP.36.201V1000-2011		10.0.0 Jul 11	<a href="https://www.atis.org/docstore/default.aspxCCSA">https://www.atis.org/docstore/default.aspxCCSA</a>
CCSA	TSD-LTE-36.201		10.0.0 Apr 15	<a href="http://www.ccsa.org.cn/ITU_spec/ITU-R/M.2012/M.2012-2/LTE/Rel-10/CCSA-TSD-LTE-36201-a00.zip">http://www.ccsa.org.cn/ITU_spec/ITU-R/M.2012/M.2012-2/LTE/Rel-10/CCSA-TSD-LTE-36201-a00.zip</a>
ETSI	ETSI TS 136 201		10.0.0 Jan 11	<a href="http://www.etsi.org/deliver/etsi_ts/136200_136299/136201/10.00.00_60/ts_136201v100000p.pdf">http://www.etsi.org/deliver/etsi_ts/136200_136299/136201/10.00.00_60/ts_136201v100000p.pdf</a>
TTC	Not applicable			
<b>Release 11</b>				
ARIB	ARIB STD-T104-36.201		11.1.0 Jul 13	<a href="http://www.arib.or.jp/english/html/overview/doc/STD-T104v2_00/2_T104/ARIB-STD-T104/Rel11/36/A36201-b10.pdf">http://www.arib.or.jp/english/html/overview/doc/STD-T104v2_00/2_T104/ARIB-STD-T104/Rel11/36/A36201-b10.pdf</a>
ATIS	ATIS.3GPP.36.201V1110-2013		11.1.0 Jun 13	<a href="https://www.atis.org/docstore/default.aspx">https://www.atis.org/docstore/default.aspx</a>
CCSA	CCSA-TSD-LTE-36.201		11.1.0 Apr 15	<a href="http://www.ccsa.org.cn/ITU_spec/ITU-R/M.2012/M.2012-2/LTE/Rel-11/CCSA-TSD-LTE-36201-b10.zip">http://www.ccsa.org.cn/ITU_spec/ITU-R/M.2012/M.2012-2/LTE/Rel-11/CCSA-TSD-LTE-36201-b10.zip</a>
ETSI	ETSI TS 136 201		11.1.0 Feb 13	<a href="http://www.etsi.org/deliver/etsi_ts/136200_136299/136201/11.01.00_60/ts_136201v110100p.pdf">http://www.etsi.org/deliver/etsi_ts/136200_136299/136201/11.01.00_60/ts_136201v110100p.pdf</a>
TTA	TTAT.3G-36.201(R11-11.1.0)		11.1.0 Aug 13	<a href="http://www.tta.or.kr/data/ttasDown.jsp?where=14688&amp;pk_num=TTAT.3G-36.201(R11-11.1.0)">http://www.tta.or.kr/data/ttasDown.jsp?where=14688&amp;pk_num=TTAT.3G-36.201(R11-11.1.0)</a>
TTC	Not applicable			
<b>Release 12</b>				
ARIB	Not applicable			
ATIS	ATIS.3GPP.36.201V1210-2015		12.1.0 May 15	<a href="https://www.atis.org/docstore/default.aspx">https://www.atis.org/docstore/default.aspx</a>
CCSA	CCSA-TSD-LTE-36.201		12.1.0 Apr 15	<a href="http://www.ccsa.org.cn/ITU_spec/ITU-R/M.2012/M.2012-2/LTE/Rel-12/CCSA-TSD-LTE-36201-c10.zip">http://www.ccsa.org.cn/ITU_spec/ITU-R/M.2012/M.2012-2/LTE/Rel-12/CCSA-TSD-LTE-36201-c10.zip</a>
ETSI	ETSI TS 136 201		12.1.0 Feb 15	<a href="http://www.etsi.org/deliver/etsi_ts/136200_136299/136201/12.01.00_60/ts_136201v120100p.pdf">http://www.etsi.org/deliver/etsi_ts/136200_136299/136201/12.01.00_60/ts_136201v120100p.pdf</a>
TTA	TTAT.3G-36.201(R12-12.1.0)		12.1.0 Apr 15	<a href="http://www.tta.or.kr/data/ttasDown.jsp?where=14688&amp;pk_num=TTAT.3G-36.201(R12-12.1.0)">http://www.tta.or.kr/data/ttasDown.jsp?where=14688&amp;pk_num=TTAT.3G-36.201(R12-12.1.0)</a>
TTC	Not applicable			

## 1.2.1.2.2 TS 36.211

**Evolved Universal Terrestrial Radio Access (E-UTRA); Physical channels and modulation**

This document describes the physical channels and modulation for E-UTRA.

SDO (2)	Document No.	Version	Issued date	Location (1)
<b>Release 10</b>				
ARIB	ARIB STD-T104-36.211		10.7.0 Jul 13	<a href="http://www.arib.or.jp/english/html/overview/doc/STD-T104v2_00/2_T104/ARIB-STD-T104/Rel10/36/A36211-a70.pdf">http://www.arib.or.jp/english/html/overview/doc/STD-T104v2_00/2_T104/ARIB-STD-T104/Rel10/36/A36211-a70.pdf</a>
ATIS	ATIS.3GPP.36.211V1070-2013		10.7.0 Jun 13	<a href="https://www.atis.org/docstore/default.aspx">https://www.atis.org/docstore/default.aspx</a>
CCSA	CCSA-TSD-LTE-36.211		10.7.0 Apr 15	<a href="http://www.ccsa.org.cn/ITU_spec/ITU-R/M.2012/M.2012-2/LTE/Rel-10/CCSA-TSD-LTE-36211-a70.zip">http://www.ccsa.org.cn/ITU_spec/ITU-R/M.2012/M.2012-2/LTE/Rel-10/CCSA-TSD-LTE-36211-a70.zip</a>
ETSI	ETSI TS 136 211		10.7.0 Apr 13	<a href="http://www.etsi.org/deliver/etsi_ts/136200_136299/136211/10.07.00_60/ts_136211v100700p.pdf">http://www.etsi.org/deliver/etsi_ts/136200_136299/136211/10.07.00_60/ts_136211v100700p.pdf</a>
TTC	Not applicable			
<b>Release 11</b>				
ARIB	ARIB STD-T104-36.211		11.6.0 Dec 14	<a href="http://www.arib.or.jp/english/html/overview/doc/STD-T104v2_60/2_T104/ARIB-STD-T104/Rel11/36/A36211-b60.pdf">http://www.arib.or.jp/english/html/overview/doc/STD-T104v2_60/2_T104/ARIB-STD-T104/Rel11/36/A36211-b60.pdf</a>
ATIS	ATIS.3GPP.36.211V1160-2015		11.6.0 May 15	<a href="https://www.atis.org/docstore/default.aspx">https://www.atis.org/docstore/default.aspx</a>
CCSA	CCSA-TSD-LTE-36.211		11.6.0 Apr 15	<a href="http://www.ccsa.org.cn/ITU_spec/ITU-R/M.2012/M.2012-2/LTE/Rel-11/CCSA-TSD-LTE-36211-b60.zip">http://www.ccsa.org.cn/ITU_spec/ITU-R/M.2012/M.2012-2/LTE/Rel-11/CCSA-TSD-LTE-36211-b60.zip</a>
ETSI	ETSI TS 136 211		11.6.0 Oct 14	<a href="http://www.etsi.org/deliver/etsi_ts/136200_136299/136211/11.06.00_60/ts_136211v110600p.pdf">http://www.etsi.org/deliver/etsi_ts/136200_136299/136211/11.06.00_60/ts_136211v110600p.pdf</a>
TTA	TTAT.3G-36.211(R11-11.2.0)		11.2.0 Aug 13	<a href="http://www.tta.or.kr/data/ttasDown.jsp?where=14688&amp;pk_num=TTAT.3G-36.211(R11-11.2.0)">http://www.tta.or.kr/data/ttasDown.jsp?where=14688&amp;pk_num=TTAT.3G-36.211(R11-11.2.0)</a>
TTC	Not applicable			
<b>Release 12</b>				
ARIB	Not applicable			
ATIS	ATIS.3GPP.36.211V1240-2015		12.4.0 May 15	<a href="https://www.atis.org/docstore/default.aspx">https://www.atis.org/docstore/default.aspx</a>
CCSA	CCSA-TSD-LTE-36.211		12.4.0 Apr 15	<a href="http://www.ccsa.org.cn/ITU_spec/ITU-R/M.2012/M.2012-2/LTE/Rel-12/CCSA-TSD-LTE-36211-c40.zip">http://www.ccsa.org.cn/ITU_spec/ITU-R/M.2012/M.2012-2/LTE/Rel-12/CCSA-TSD-LTE-36211-c40.zip</a>
ETSI	ETSI TS 136 211		12.4.0 Feb 15	<a href="http://www.etsi.org/deliver/etsi_ts/136200_136299/136211/12.04.00_60/ts_136211v120400p.pdf">http://www.etsi.org/deliver/etsi_ts/136200_136299/136211/12.04.00_60/ts_136211v120400p.pdf</a>
TTA	TTAT.3G-36.211(R12-12.4.0)		12.4.0 Apr 15	<a href="http://www.tta.or.kr/data/ttasDown.jsp?where=14688&amp;pk_num=TTAT.3G-36.211(R12-12.4.0)">http://www.tta.or.kr/data/ttasDown.jsp?where=14688&amp;pk_num=TTAT.3G-36.211(R12-12.4.0)</a>
TTC	Not applicable			

## 1.2.1.2.3 TS 36.212

**Evolved Universal Terrestrial Radio Access (E-UTRA); Multiplexing and channel coding**

This document specifies the coding, multiplexing and mapping to physical channels for E-UTRA.

SDO (2)	Document No.	Version	Issued date	Location (1)
<b>Release 10</b>				
ARIB	ARIB STD-T104-36.212		10.8.0 Sep 13	<a href="http://www.arib.or.jp/english/html/overview/doc/STD-T104v2_10/2_T104/ARIB-STD-T104/Rel10/36/A36212-a80.pdf">http://www.arib.or.jp/english/html/overview/doc/STD-T104v2_10/2_T104/ARIB-STD-T104/Rel10/36/A36212-a80.pdf</a>
ATIS	ATIS.3GPP.36.212V1080-2015		10.8.0 May 15	<a href="https://www.atis.org/docstore/default.aspx">https://www.atis.org/docstore/default.aspx</a>
CCSA	CCSA-TSD-LTE-36.212		10.8.0 Apr 15	<a href="http://www.ccsa.org.cn/ITU_spec/ITU-R/M.2012/M.2012-2/LTE/Rel-10/CCSA-TSD-LTE-36212-a80.zip">http://www.ccsa.org.cn/ITU_spec/ITU-R/M.2012/M.2012-2/LTE/Rel-10/CCSA-TSD-LTE-36212-a80.zip</a>
ETSI	ETSI TS 136 212		10.8.0 Jul 13	<a href="http://www.etsi.org/deliver/etsi_ts/136200_136299/136212/10.08.00_60/ts_136212v100800p.pdf">http://www.etsi.org/deliver/etsi_ts/136200_136299/136212/10.08.00_60/ts_136212v100800p.pdf</a>
TTC	Not applicable			



**Release 11**

ARIB	ARIB STD-T104-36.212	11.5.1	Dec 14	<a href="http://www.arib.or.jp/english/html/overview/doc/STD-T104v2_60/2_T104/ARIB-STD-T104/Rel11/36/A36212-b51.pdf">http://www.arib.or.jp/english/html/overview/doc/STD-T104v2_60/2_T104/ARIB-STD-T104/Rel11/36/A36212-b51.pdf</a>
ATIS	ATIS.3GPP.36.212V1151-2015	11.5.1	May 15	<a href="https://www.atis.org/docstore/default.aspx">https://www.atis.org/docstore/default.aspx</a>
CCSA	CCSA-TSD-LTE-36.212	11.5.1	Apr 15	<a href="http://www.ccsa.org.cn/ITU_spec/ITU-R/M.2012/M.2012-2/LTE/Rel-11/CCSA-TSD-LTE-36212-b51.zip">http://www.ccsa.org.cn/ITU_spec/ITU-R/M.2012/M.2012-2/LTE/Rel-11/CCSA-TSD-LTE-36212-b51.zip</a>
ETSI	ETSI TS 136 212	11.5.1	Oct 14	<a href="http://www.etsi.org/deliver/etsi_ts/136200_136299/136212/11.05.01_60/ts_136212v110501p.pdf">http://www.etsi.org/deliver/etsi_ts/136200_136299/136212/11.05.01_60/ts_136212v110501p.pdf</a>
TTA	TTAT.3G-36.212(R11-11.2.0)	11.2.0	Aug 13	<a href="http://www.tta.or.kr/data/ttasDown.jsp?where=14688&amp;pk_num=TTAT.3G-36.212(R11-11.2.0)">http://www.tta.or.kr/data/ttasDown.jsp?where=14688&amp;pk_num=TTAT.3G-36.212(R11-11.2.0)</a>
TTC	Not applicable			

**Release 12**

ARIB	Not applicable			
ATIS	ATIS.3GPP.36.212V1230-2015	12.3.0	May 15	<a href="https://www.atis.org/docstore/default.aspx">https://www.atis.org/docstore/default.aspx</a>
CCSA	CCSA-TSD-LTE-36.212	12.3.0	Apr 15	<a href="http://www.ccsa.org.cn/ITU_spec/ITU-R/M.2012/M.2012-2/LTE/Rel-12/CCSA-TSD-LTE-36212-c30.zip">http://www.ccsa.org.cn/ITU_spec/ITU-R/M.2012/M.2012-2/LTE/Rel-12/CCSA-TSD-LTE-36212-c30.zip</a>
ETSI	ETSI TS 136 212	12.3.0	Feb 15	<a href="http://www.etsi.org/deliver/etsi_ts/136200_136299/136212/12.03.00_60/ts_136212v120300p.pdf">http://www.etsi.org/deliver/etsi_ts/136200_136299/136212/12.03.00_60/ts_136212v120300p.pdf</a>
TTA	TTAT.3G-36.212(R12-12.3.0)	12.3.0	Apr 15	<a href="http://www.tta.or.kr/data/ttasDown.jsp?where=14688&amp;pk_num=TTAT.3G-36.212(R12-12.3.0)">http://www.tta.or.kr/data/ttasDown.jsp?where=14688&amp;pk_num=TTAT.3G-36.212(R12-12.3.0)</a>
TTC	Not applicable			

**1.2.1.2.4 TS 36.213****Evolved Universal Terrestrial Radio Access (E-UTRA); Physical layer procedures**

This document specifies and establishes the characteristics of the physical layer procedures for E-UTRA.

SDO (2)	Document No.	Version	Issued date	Location (1)
<b>Release 10</b>				
ARIB	ARIB STD-T104-36.213		10.12.0 Jul 14	<a href="http://www.arib.or.jp/english/html/overview/doc/STD-T104v2_40/2_T104/ARIB-STD-T104/Rel10/36/A36213-ac0.pdf">http://www.arib.or.jp/english/html/overview/doc/STD-T104v2_40/2_T104/ARIB-STD-T104/Rel10/36/A36213-ac0.pdf</a>
ATIS	ATIS.3GPP.36.213V10120-2015		10.12.0 May 15	<a href="https://www.atis.org/docstore/default.aspx">https://www.atis.org/docstore/default.aspx</a>
CCSA	CCSA-TSD-LTE-36.213		10.12.0 Apr 15	<a href="http://www.ccsa.org.cn/ITU_spec/ITU-R/M.2012/M.2012-2/LTE/Rel-10/CCSA-TSD-LTE-36213-ac0.zip">http://www.ccsa.org.cn/ITU_spec/ITU-R/M.2012/M.2012-2/LTE/Rel-10/CCSA-TSD-LTE-36213-ac0.zip</a>
ETSI	ETSI TS 136 213		10.12.0 Mar 14	<a href="http://www.etsi.org/deliver/etsi_ts/136200_136299/136213/10.12.00_60/ts_136213v101200p.pdf">http://www.etsi.org/deliver/etsi_ts/136200_136299/136213/10.12.00_60/ts_136213v101200p.pdf</a>
TTC	Not applicable			
<b>Release 11</b>				
ARIB	ARIB STD-T104-36.213		11.9.0 Mar 15	<a href="http://www.arib.or.jp/english/html/overview/doc/STD-T104v2_70/2_T104/ARIB-STD-T104/Rel11/36/A36213-b90.pdf">http://www.arib.or.jp/english/html/overview/doc/STD-T104v2_70/2_T104/ARIB-STD-T104/Rel11/36/A36213-b90.pdf</a>
ATIS	ATIS.3GPP.36.213V1190-2015		11.9.0 May 15	<a href="https://www.atis.org/docstore/default.aspx">https://www.atis.org/docstore/default.aspx</a>
CCSA	CCSA-TSD-LTE-36.213		11.10.0 Apr 15	<a href="http://www.ccsa.org.cn/ITU_spec/ITU-R/M.2012/M.2012-2/LTE/Rel-11/CCSA-TSD-LTE-36213-ba0.zip">http://www.ccsa.org.cn/ITU_spec/ITU-R/M.2012/M.2012-2/LTE/Rel-11/CCSA-TSD-LTE-36213-ba0.zip</a>
ETSI	ETSI TS 136 213		11.9.0 Feb 15	<a href="http://www.etsi.org/deliver/etsi_ts/136200_136299/136213/11.09.00_60/ts_136213v110900p.pdf">http://www.etsi.org/deliver/etsi_ts/136200_136299/136213/11.09.00_60/ts_136213v110900p.pdf</a>
TTA	TTAT.3G-36.213(R11-11.2.0)		11.2.0 Aug 13	<a href="http://www.tta.or.kr/data/ttasDown.jsp?where=14688&amp;pk_num=TTAT.3G-36.213(R11-11.2.0)">http://www.tta.or.kr/data/ttasDown.jsp?where=14688&amp;pk_num=TTAT.3G-36.213(R11-11.2.0)</a>
TTC	Not applicable			
<b>Release 12</b>				
ARIB	Not applicable			
ATIS	ATIS.3GPP.36.213V1240-2015		12.4.0 May 15	<a href="https://www.atis.org/docstore/default.aspx">https://www.atis.org/docstore/default.aspx</a>
CCSA	CCSA-TSD-LTE-36.213		12.4.0 Apr 15	<a href="http://www.ccsa.org.cn/ITU_spec/ITU-R/M.2012/M.2012-2/LTE/Rel-12/CCSA-TSD-LTE-36213-c40.zip">http://www.ccsa.org.cn/ITU_spec/ITU-R/M.2012/M.2012-2/LTE/Rel-12/CCSA-TSD-LTE-36213-c40.zip</a>
ETSI	ETSI TS 136 213		12.4.0 Feb 15	<a href="http://www.etsi.org/deliver/etsi_ts/136200_136299/136213/12.04.00_60/ts_136213v120400p.pdf">http://www.etsi.org/deliver/etsi_ts/136200_136299/136213/12.04.00_60/ts_136213v120400p.pdf</a>
TTA	TTAT.3G-36.213(R12-12.4.0)		12.4.0 Apr 15	<a href="http://www.tta.or.kr/data/ttasDown.jsp?where=14688&amp;pk_num=TTAT.3G-36.213(R12-12.4.0)">http://www.tta.or.kr/data/ttasDown.jsp?where=14688&amp;pk_num=TTAT.3G-36.213(R12-12.4.0)</a>
TTC	Not applicable			

## 1.2.1.2.5 TS 36.214

**Evolved Universal Terrestrial Radio Access (E-UTRA); Physical layer; Measurements**

This document contains the description and definition of the measurements done at the UE and network in order to support operation in idle mode and connected mode in E-UTRA.

SDO (2)	Document No.	Version	Issued date	Location (1)
<b>Release 10</b>				
ARIB	ARIB STD-T104-36.214		10.1.0 Sep 11	<a href="http://www.arib.or.jp/english/html/overview/doc/STD-T104v1_00/2_T104/ARIB-STD-T104/Rel10/36/A36214-a10.pdf">http://www.arib.or.jp/english/html/overview/doc/STD-T104v1_00/2_T104/ARIB-STD-T104/Rel10/36/A36214-a10.pdf</a>
ATIS	ATIS.3GPP.36.214V1010-2011		10.1.0 Jul 11	<a href="https://www.atis.org/docstore/default.aspx">https://www.atis.org/docstore/default.aspx</a>
CCSA	CCSA-TSD-LTE-36.214		10.1.0 Apr 15	<a href="http://www.ccsa.org.cn/ITU_spec/ITU-R/M.2012/M.2012-2/LTE/Rel-10/CCSA-TSD-LTE-36214-a10.zip">http://www.ccsa.org.cn/ITU_spec/ITU-R/M.2012/M.2012-2/LTE/Rel-10/CCSA-TSD-LTE-36214-a10.zip</a>
ETSI	ETSI TS 136 214		10.1.0 Apr 11	<a href="http://www.etsi.org/deliver/etsi_ts/136200_136299/136214/10.01.00_60/ts_136214v100100p.pdf">http://www.etsi.org/deliver/etsi_ts/136200_136299/136214/10.01.00_60/ts_136214v100100p.pdf</a>
TTC	Not applicable			
<b>Release 11</b>				
ARIB	ARIB STD-T104-36.214		11.1.0 Jul 13	<a href="http://www.arib.or.jp/english/html/overview/doc/STD-T104v2_00/2_T104/ARIB-STD-T104/Rel11/36/A36214-b10.pdf">http://www.arib.or.jp/english/html/overview/doc/STD-T104v2_00/2_T104/ARIB-STD-T104/Rel11/36/A36214-b10.pdf</a>
ATIS	ATIS.3GPP.36.214V1110-2013		11.1.0 Jun 13	<a href="https://www.atis.org/docstore/default.aspx">https://www.atis.org/docstore/default.aspx</a>
CCSA	CCSA-TSD-LTE-36.214		11.1.0 Apr 15	<a href="http://www.ccsa.org.cn/ITU_spec/ITU-R/M.2012/M.2012-2/LTE/Rel-11/CCSA-TSD-LTE-36214-b10.zip">http://www.ccsa.org.cn/ITU_spec/ITU-R/M.2012/M.2012-2/LTE/Rel-11/CCSA-TSD-LTE-36214-b10.zip</a>
ETSI	ETSI TS 136 214		11.1.0 Feb 13	<a href="http://www.etsi.org/deliver/etsi_ts/136200_136299/136214/11.01.00_60/ts_136214v110100p.pdf">http://www.etsi.org/deliver/etsi_ts/136200_136299/136214/11.01.00_60/ts_136214v110100p.pdf</a>
TTA	TTAT.3G-36.214(R11-11.1.0)		11.1.0 Aug 13	<a href="http://www.tta.or.kr/data/ttasDown.jsp?where=14688&amp;pk_num=TTAT.3G-36.214(R11-11.1.0)">http://www.tta.or.kr/data/ttasDown.jsp?where=14688&amp;pk_num=TTAT.3G-36.214(R11-11.1.0)</a>
TTC	Not applicable			
<b>Release 12</b>				
ARIB	Not applicable			
ATIS	ATIS.3GPP.36.214V1210-2015		12.1.0 May 15	<a href="https://www.atis.org/docstore/default.aspx">https://www.atis.org/docstore/default.aspx</a>
CCSA	CCSA-TSD-LTE-36.214		12.1.0 Apr 15	<a href="http://www.ccsa.org.cn/ITU_spec/ITU-R/M.2012/M.2012-2/LTE/Rel-12/CCSA-TSD-LTE-36214-c10.zip">http://www.ccsa.org.cn/ITU_spec/ITU-R/M.2012/M.2012-2/LTE/Rel-12/CCSA-TSD-LTE-36214-c10.zip</a>
ETSI	ETSI TS 136 214		12.1.0 Feb 15	<a href="http://www.etsi.org/deliver/etsi_ts/136200_136299/136214/12.01.00_60/ts_136214v120100p.pdf">http://www.etsi.org/deliver/etsi_ts/136200_136299/136214/12.01.00_60/ts_136214v120100p.pdf</a>
TTA	TTAT.3G-36.214(R12-12.1.0)		12.1.0 Apr 15	<a href="http://www.tta.or.kr/data/ttasDown.jsp?where=14688&amp;pk_num=TTAT.3G-36.214(R12-12.1.0)">http://www.tta.or.kr/data/ttasDown.jsp?where=14688&amp;pk_num=TTAT.3G-36.214(R12-12.1.0)</a>
TTC	Not applicable			

## 1.2.1.2.6 TS 36.216

**Evolved Universal Terrestrial Radio Access (E-UTRA); Physical layer for relaying operation**

This document describes the characteristics of eNodeB – relay node transmissions.

SDO (2)	Document No.	Version	Issued date	Location (1)
<b>Release 10</b>				
ARIB	ARIB STD-T104-36.216		10.3.1 Dec 11	<a href="http://www.arib.or.jp/english/html/overview/doc/STD-T104v1_10/2_T104/ARIB-STD-T104/Rel10/36/A36216-a31.pdf">http://www.arib.or.jp/english/html/overview/doc/STD-T104v1_10/2_T104/ARIB-STD-T104/Rel10/36/A36216-a31.pdf</a>
ATIS	ATIS.3GPP.36.216V1031-2013		10.3.1 Jun 13	<a href="https://www.atis.org/docstore/default.aspx">https://www.atis.org/docstore/default.aspx</a>
CCSA	CCSA-TSD-LTE-36.216		10.3.1 Apr 15	<a href="http://www.ccsa.org.cn/ITU_spec/ITU-R/M.2012/M.2012-2/LTE/Rel-10/CCSA-TSD-LTE-36216-a31.zip">http://www.ccsa.org.cn/ITU_spec/ITU-R/M.2012/M.2012-2/LTE/Rel-10/CCSA-TSD-LTE-36216-a31.zip</a>
ETSI	ETSI TS 136 216		10.3.1 Oct 11	<a href="http://www.etsi.org/deliver/etsi_ts/136200_136299/136216/10.03.01_60/ts_136216v100301p.pdf">http://www.etsi.org/deliver/etsi_ts/136200_136299/136216/10.03.01_60/ts_136216v100301p.pdf</a>
TTC	Not applicable			

**Release 11**

ARIB	ARIB STD-T104-36.216	11.0.0	Jul 13	<a href="http://www.arib.or.jp/english/html/overview/doc/STD-T104v2_00/2_T104/ARIB-STD-T104/Rel11/36/A36216-b00.pdf">http://www.arib.or.jp/english/html/overview/doc/STD-T104v2_00/2_T104/ARIB-STD-T104/Rel11/36/A36216-b00.pdf</a>
ATIS	ATIS.3GPP.36.216V1100-2013	11.0.0	Jun 13	<a href="https://www.atis.org/docstore/default.aspx">https://www.atis.org/docstore/default.aspx</a>
CCSA	CCSA-TSD-LTE-36.216	11.0.0	Apr 15	<a href="http://www.ccsa.org.cn/ITU_spec/ITU-R/M.2012/M.2012-2/LTE/Rel-11/CCSA-TSD-LTE-36216-b00.zip">http://www.ccsa.org.cn/ITU_spec/ITU-R/M.2012/M.2012-2/LTE/Rel-11/CCSA-TSD-LTE-36216-b00.zip</a>
ETSI	ETSI TS 136 216	11.0.0	Oct 12	<a href="http://www.etsi.org/deliver/etsi_ts/136200_136299/136216/11.00.00_60/ts_136216v110000p.pdf">http://www.etsi.org/deliver/etsi_ts/136200_136299/136216/11.00.00_60/ts_136216v110000p.pdf</a>
TTA	TTAT.3G-36.216(R11-11.0.0)	11.0.0	Aug 13	<a href="http://www.tta.or.kr/data/ttasDown.jsp?where=14688&amp;pk_num=TTAT.3G-36.216(R11-11.0.0)">http://www.tta.or.kr/data/ttasDown.jsp?where=14688&amp;pk_num=TTAT.3G-36.216(R11-11.0.0)</a>
TTC	Not applicable			

**Release 12**

ARIB	Not applicable			
ATIS	ATIS.3GPP.36.216V1200-2015	12.0.0	May 15	<a href="https://www.atis.org/docstore/default.aspx">https://www.atis.org/docstore/default.aspx</a>
CCSA	CCSA-TSD-LTE-36.216	12.0.0	Apr 15	<a href="http://www.ccsa.org.cn/ITU_spec/ITU-R/M.2012/M.2012-2/LTE/Rel-12/CCSA-TSD-LTE-36216-c00.zip">http://www.ccsa.org.cn/ITU_spec/ITU-R/M.2012/M.2012-2/LTE/Rel-12/CCSA-TSD-LTE-36216-c00.zip</a>
ETSI	ETSI TS 136 216	12.0.0	Oct 14	<a href="http://www.etsi.org/deliver/etsi_ts/136200_136299/136216/12.00.00_60/ts_136216v120000p.pdf">http://www.etsi.org/deliver/etsi_ts/136200_136299/136216/12.00.00_60/ts_136216v120000p.pdf</a>
TTA	TTAT.3G-36.216(R12-12.0.0)	12.0.0	Apr 15	<a href="http://www.tta.or.kr/data/ttasDown.jsp?where=14688&amp;pk_num=TTAT.3G-36.216(R12-12.0.0)">http://www.tta.or.kr/data/ttasDown.jsp?where=14688&amp;pk_num=TTAT.3G-36.216(R12-12.0.0)</a>
TTC	Not applicable			

**1.2.1.3 Radio Layers 2 & 3****1.2.1.3.1 TS 36.300****Evolved Universal Terrestrial Radio Access (E-UTRA) and Evolved Universal Terrestrial Radio Access Network (E-UTRAN); Overall description; Stage 2**

This document provides an overview and overall description of the E-UTRAN radio interface protocol architecture. Details of the radio interface protocols are specified in companion specifications of the 36 series.

SDO (2)	Document No.	Version	Issued date	Location (1)
<b>Release 10</b>				
ARIB	ARIB STD-T104-36.300	10.12.0	Mar 15	<a href="http://www.arib.or.jp/english/html/overview/doc/STD-T104v2_70/2_T104/ARIB-STD-T104/Rel10/36/A36300-ac0.pdf">http://www.arib.or.jp/english/html/overview/doc/STD-T104v2_70/2_T104/ARIB-STD-T104/Rel10/36/A36300-ac0.pdf</a>
ATIS	ATIS.3GPP.36.300V10120-2015	10.12.0	May 15	<a href="https://www.atis.org/docstore/default.aspx">https://www.atis.org/docstore/default.aspx</a>
CCSA	CCSA-TSD-LTE-36.300	10.12.0	Apr 15	<a href="http://www.ccsa.org.cn/ITU_spec/ITU-R/M.2012/M.2012-2/LTE/Rel-10/CCSA-TSD-LTE-36300-ac0.zip">http://www.ccsa.org.cn/ITU_spec/ITU-R/M.2012/M.2012-2/LTE/Rel-10/CCSA-TSD-LTE-36300-ac0.zip</a>
ETSI	ETSI TS 136 300	10.12.0	Feb 15	<a href="http://www.etsi.org/deliver/etsi_ts/136300_136399/136300/10.12.00_60/ts_136300v101200p.pdf">http://www.etsi.org/deliver/etsi_ts/136300_136399/136300/10.12.00_60/ts_136300v101200p.pdf</a>
TTC	Not applicable			
<b>Release 11</b>				
ARIB	ARIB STD-T104-36.300	11.12.0	Mar 15	<a href="http://www.arib.or.jp/english/html/overview/doc/STD-T104v2_70/2_T104/ARIB-STD-T104/Rel11/36/A36300-bc0.pdf">http://www.arib.or.jp/english/html/overview/doc/STD-T104v2_70/2_T104/ARIB-STD-T104/Rel11/36/A36300-bc0.pdf</a>
ATIS	ATIS.3GPP.36.300V11120-2015	11.12.0	May 15	<a href="https://www.atis.org/docstore/default.aspx">https://www.atis.org/docstore/default.aspx</a>
CCSA	CCSA-TSD-LTE-36.300	11.12.0	Apr 15	<a href="http://www.ccsa.org.cn/ITU_spec/ITU-R/M.2012/M.2012-2/LTE/Rel-11/CCSA-TSD-LTE-36300-bc0.zip">http://www.ccsa.org.cn/ITU_spec/ITU-R/M.2012/M.2012-2/LTE/Rel-11/CCSA-TSD-LTE-36300-bc0.zip</a>
ETSI	ETSI TS 136 300	11.12.0	Feb 15	<a href="http://www.etsi.org/deliver/etsi_ts/136300_136399/136300/11.12.00_60/ts_136300v111200p.pdf">http://www.etsi.org/deliver/etsi_ts/136300_136399/136300/11.12.00_60/ts_136300v111200p.pdf</a>
TTA	TTAT.3G-36.300(R11-11.5.0)	11.5.0	Aug 13	<a href="http://www.tta.or.kr/data/ttasDown.jsp?where=14688&amp;pk_num=TTAT.3G-36.300(R11-11.5.0)">http://www.tta.or.kr/data/ttasDown.jsp?where=14688&amp;pk_num=TTAT.3G-36.300(R11-11.5.0)</a>
TTC	Not applicable			

**Release 12**

ARIB	Not applicable				
ATIS	ATIS.3GPP.36.300V1240-2015	12.4.0	May 15		<a href="https://www.atis.org/docstore/default.aspx">https://www.atis.org/docstore/default.aspx</a>
CCSA	CCSA-TSD-LTE-36.300	12.4.0	Apr 15		<a href="http://www.ccsa.org.cn/ITU_spec/ITU-R/M.2012/M.2012-2/LTE/Rel-12/CCSA-TSD-LTE-36300-c40.zip">http://www.ccsa.org.cn/ITU_spec/ITU-R/M.2012/M.2012-2/LTE/Rel-12/CCSA-TSD-LTE-36300-c40.zip</a>
ETSI	ETSI TS 136 300	12.4.0	Feb 15		<a href="http://www.etsi.org/deliver/etsi_ts/136300_136399/136300/12.04.00_60/ts_136300v120400p.pdf">http://www.etsi.org/deliver/etsi_ts/136300_136399/136300/12.04.00_60/ts_136300v120400p.pdf</a>
TTA	TTAT.3G-36.300(R12-12.4.0)	12.4.0	Apr 15		<a href="http://www.tta.or.kr/data/ttasDown.jsp?where=14688&amp;pk_num=TTAT.3G-36.300(R12-12.4.0)">http://www.tta.or.kr/data/ttasDown.jsp?where=14688&amp;pk_num=TTAT.3G-36.300(R12-12.4.0)</a>
TTC	Not applicable				

**1.2.1.3.2 TS 36.302****Evolved Universal Terrestrial Radio Access (E-UTRA); Services provided by the physical layer**

This document is a technical specification of the services provided by the physical layer of E-UTRA to upper layers.

SDO (2)	Document No.	Version	Issued date		Location (1)
<b>Release 10</b>					
ARIB	ARIB STD-T104-36.302		10.6.0	Dec 13	<a href="http://www.arib.or.jp/english/html/overview/doc/STD-T104v2_20/2_T104/ARIB-STD-T104/Rel10/36/A36302-a60.pdf">http://www.arib.or.jp/english/html/overview/doc/STD-T104v2_20/2_T104/ARIB-STD-T104/Rel10/36/A36302-a60.pdf</a>
ATIS	ATIS.3GPP.36.302V1060-2015		10.6.0	May 15	<a href="https://www.atis.org/docstore/default.aspx">https://www.atis.org/docstore/default.aspx</a>
CCSA	CCSA-TSD-LTE-36.302		10.6.0	Apr 15	<a href="http://www.ccsa.org.cn/ITU_spec/ITU-R/M.2012/M.2012-2/LTE/Rel-10/CCSA-TSD-LTE-36302-a60.zip">http://www.ccsa.org.cn/ITU_spec/ITU-R/M.2012/M.2012-2/LTE/Rel-10/CCSA-TSD-LTE-36302-a60.zip</a>
ETSI	ETSI TS 136 302		10.6.0	Sep 13	<a href="http://www.etsi.org/deliver/etsi_ts/136300_136399/136302/10.06.00_60/ts_136302v100600p.pdf">http://www.etsi.org/deliver/etsi_ts/136300_136399/136302/10.06.00_60/ts_136302v100600p.pdf</a>
TTC	Not applicable				
<b>Release 11</b>					
ARIB	ARIB STD-T104-36.302		11.5.0	Jul 14	<a href="http://www.arib.or.jp/english/html/overview/doc/STD-T104v2_40/2_T104/ARIB-STD-T104/Rel11/36/A36302-b50.pdf">http://www.arib.or.jp/english/html/overview/doc/STD-T104v2_40/2_T104/ARIB-STD-T104/Rel11/36/A36302-b50.pdf</a>
ATIS	ATIS.3GPP.36.302V1150-2015		11.5.0	May 15	<a href="https://www.atis.org/docstore/default.aspx">https://www.atis.org/docstore/default.aspx</a>
CCSA	CCSA-TSD-LTE-36.302		11.5.0	Apr 15	<a href="http://www.ccsa.org.cn/ITU_spec/ITU-R/M.2012/M.2012-2/LTE/Rel-11/CCSA-TSD-LTE-36302-b50.zip">http://www.ccsa.org.cn/ITU_spec/ITU-R/M.2012/M.2012-2/LTE/Rel-11/CCSA-TSD-LTE-36302-b50.zip</a>
ETSI	ETSI TS 136 302		11.5.0	Mar 14	<a href="http://www.etsi.org/deliver/etsi_ts/136300_136399/136302/11.05.00_60/ts_136302v110500p.pdf">http://www.etsi.org/deliver/etsi_ts/136300_136399/136302/11.05.00_60/ts_136302v110500p.pdf</a>
TTA	TTAT.3G-36.302(R11-11.2.0)		11.2.0	Aug 13	<a href="http://www.tta.or.kr/data/ttasDown.jsp?where=14688&amp;pk_num=TTAT.3G-36.302(R11-11.2.0)">http://www.tta.or.kr/data/ttasDown.jsp?where=14688&amp;pk_num=TTAT.3G-36.302(R11-11.2.0)</a>
TTC	Not applicable				
<b>Release 12</b>					
ARIB	Not applicable				
ATIS	ATIS.3GPP.36.302V1220-2015		12.2.0	May 15	<a href="https://www.atis.org/docstore/default.aspx">https://www.atis.org/docstore/default.aspx</a>
CCSA	CCSA-TSD-LTE-36.302		12.2.0	Apr 15	<a href="http://www.ccsa.org.cn/ITU_spec/ITU-R/M.2012/M.2012-2/LTE/Rel-12/CCSA-TSD-LTE-36302-c20.zip">http://www.ccsa.org.cn/ITU_spec/ITU-R/M.2012/M.2012-2/LTE/Rel-12/CCSA-TSD-LTE-36302-c20.zip</a>
ETSI	ETSI TS 136 302		12.2.0	Feb 15	<a href="http://www.etsi.org/deliver/etsi_ts/136300_136399/136302/12.02.00_60/ts_136302v120200p.pdf">http://www.etsi.org/deliver/etsi_ts/136300_136399/136302/12.02.00_60/ts_136302v120200p.pdf</a>
TTA	TTAT.3G-36.302(R12-12.2.0)		12.2.0	Apr 15	<a href="http://www.tta.or.kr/data/ttasDown.jsp?where=14688&amp;pk_num=TTAT.3G-36.302(R12-12.2.0)">http://www.tta.or.kr/data/ttasDown.jsp?where=14688&amp;pk_num=TTAT.3G-36.302(R12-12.2.0)</a>
TTC	Not applicable				

**1.2.1.3.3 TS 36.304****Evolved Universal Terrestrial Radio Access (E-UTRA); User Equipment (UE) procedures in idle mode**

This document specifies the Access Stratum (AS) part of the Idle Mode procedures applicable to a UE. This document specifies the model for the functional division between the NAS and AS in a UE. This document applies to all UEs that support at least E-UTRA, including multi-RAT UEs as described in 3GPP specifications, in the following cases: (i) When the UE is camped on an E-UTRA cell; (ii) When the UE is searching for a cell to camp on.

SDO (2)	Document No.	Version	Issued date		Location (1)
<b>Release 10</b>					
ARIB	ARIB STD-T104-36.304		10.8.0	Jul 14	<a href="http://www.arib.or.jp/english/html/overview/doc/STD-T104v2_40/2_T104/ARIB-STD-T104/Rel10/36/A36304-a80.pdf">http://www.arib.or.jp/english/html/overview/doc/STD-T104v2_40/2_T104/ARIB-STD-T104/Rel10/36/A36304-a80.pdf</a>
ATIS	ATIS.3GPP.36.304V1080-2015		10.8.0	May 15	<a href="https://www.atis.org/docstore/default.aspx">https://www.atis.org/docstore/default.aspx</a>
CCSA	CCSA-TSD-LTE-36.304		10.8.0	Apr 15	<a href="http://www.ccsa.org.cn/ITU_spec/ITU-R/M.2012/M.2012-2/LTE/Rel-10/CCSA-TSD-LTE-36304-a80.zip">http://www.ccsa.org.cn/ITU_spec/ITU-R/M.2012/M.2012-2/LTE/Rel-10/CCSA-TSD-LTE-36304-a80.zip</a>
ETSI	ETSI TS 136 304		10.8.0	Mar 14	<a href="http://www.etsi.org/deliver/etsi_ts/136300_136399/136304/10.08.00_60/ts_136304v100800p.pdf">http://www.etsi.org/deliver/etsi_ts/136300_136399/136304/10.08.00_60/ts_136304v100800p.pdf</a>
TTC	Not applicable				
<b>Release 11</b>					
ARIB	ARIB STD-T104-36.304		11.6.0	Mar 14	<a href="http://www.arib.or.jp/english/html/overview/doc/STD-T104v2_30/2_T104/ARIB-STD-T104/Rel11/36/A36304-b60.pdf">http://www.arib.or.jp/english/html/overview/doc/STD-T104v2_30/2_T104/ARIB-STD-T104/Rel11/36/A36304-b60.pdf</a>
ATIS	ATIS.3GPP.36.304V1160-2015		11.6.0	May 15	<a href="https://www.atis.org/docstore/default.aspx">https://www.atis.org/docstore/default.aspx</a>
CCSA	CCSA-TSD-LTE-36.304		11.6.0	Apr 15	<a href="http://www.ccsa.org.cn/ITU_spec/ITU-R/M.2012/M.2012-2/LTE/Rel-11/CCSA-TSD-LTE-36304-b60.zip">http://www.ccsa.org.cn/ITU_spec/ITU-R/M.2012/M.2012-2/LTE/Rel-11/CCSA-TSD-LTE-36304-b60.zip</a>
ETSI	ETSI TS 136 304		11.6.0	Jan 14	<a href="http://www.etsi.org/deliver/etsi_ts/136300_136399/136304/11.06.00_60/ts_136304v110600p.pdf">http://www.etsi.org/deliver/etsi_ts/136300_136399/136304/11.06.00_60/ts_136304v110600p.pdf</a>
TTA	TTAT.3G-36.304(R11-11.3.0)		11.3.0	Aug 13	<a href="http://www.tta.or.kr/data/ttasDown.jsp?where=14688&amp;pk_num=TTAT.3G-36.304(R11-11.3.0)">http://www.tta.or.kr/data/ttasDown.jsp?where=14688&amp;pk_num=TTAT.3G-36.304(R11-11.3.0)</a>
TTC	Not applicable				
<b>Release 12</b>					
ARIB	Not applicable				
ATIS	ATIS.3GPP.36.304V1230-2015		12.3.0	May 15	<a href="https://www.atis.org/docstore/default.aspx">https://www.atis.org/docstore/default.aspx</a>
CCSA	CCSA-TSD-LTE-36.304		12.3.0	Apr 15	<a href="http://www.ccsa.org.cn/ITU_spec/ITU-R/M.2012/M.2012-2/LTE/Rel-12/CCSA-TSD-LTE-36304-c30.zip">http://www.ccsa.org.cn/ITU_spec/ITU-R/M.2012/M.2012-2/LTE/Rel-12/CCSA-TSD-LTE-36304-c30.zip</a>
ETSI	ETSI TS 136 304		12.3.0	Feb 15	<a href="http://www.etsi.org/deliver/etsi_ts/136300_136399/136304/12.03.00_60/ts_136304v120300p.pdf">http://www.etsi.org/deliver/etsi_ts/136300_136399/136304/12.03.00_60/ts_136304v120300p.pdf</a>
TTA	TTAT.3G-36.304(R12-12.3.0)		12.3.0	Apr 15	<a href="http://www.tta.or.kr/data/ttasDown.jsp?where=14688&amp;pk_num=TTAT.3G-36.304(R12-12.3.0)">http://www.tta.or.kr/data/ttasDown.jsp?where=14688&amp;pk_num=TTAT.3G-36.304(R12-12.3.0)</a>
TTC	Not applicable				

**1.2.1.3.4 TS 36.305****Evolved Universal Terrestrial Radio Access Network (E-UTRAN); Stage 2 functional specification of User Equipment (UE) positioning in E-UTRAN**

This document specifies the stage 2 of the UE positioning function of E-UTRAN, which provides the mechanisms to support or assist the calculation of the geographical position of a UE. The purpose of this stage 2 specification is to define the E-UTRAN UE Positioning architecture, functional entities and operations to support positioning methods. This description is confined to the E-UTRAN Access Stratum. This stage 2 specification covers the E-UTRAN positioning methods, state descriptions, and message flows to support UE positioning.

SDO (2)	Document No.	Version	Issued date		Location (1)
<b>Release 10</b>					

## 28

ARIB	ARIB STD-T104-36.305	10.5.0	Mar 13	<a href="http://www.arib.or.jp/english/html/overview/doc/STD-T104v1_50/2_T104/ARIB-STD-T104/Rel10/36/A36305-a50.pdf">http://www.arib.or.jp/english/html/overview/doc/STD-T104v1_50/2_T104/ARIB-STD-T104/Rel10/36/A36305-a50.pdf</a>
ATIS	ATIS.3GPP.36.305V1050-2013	10.5.0	Jun 13	<a href="https://www.atis.org/docstore/default.aspx">https://www.atis.org/docstore/default.aspx</a>
CCSA	CCSA-TSD-LTE-36.305	10.5.0	Apr 15	<a href="http://www.ccsa.org.cn/ITU_spec/ITU-R/M.2012/M.2012-2/LTE/Rel-10/CCSA-TSD-LTE-36305-a50.zip">http://www.ccsa.org.cn/ITU_spec/ITU-R/M.2012/M.2012-2/LTE/Rel-10/CCSA-TSD-LTE-36305-a50.zip</a>
ETSI	ETSI TS 136 305	10.5.0	Feb 13	<a href="http://www.etsi.org/deliver/etsi_ts/136300_136399/136305/10.05.00_60/ts_136305v100500p.pdf">http://www.etsi.org/deliver/etsi_ts/136300_136399/136305/10.05.00_60/ts_136305v100500p.pdf</a>
TTC	Not applicable			

### Release 11

ARIB	ARIB STD-T104-36.305	11.3.0	Jul 13	<a href="http://www.arib.or.jp/english/html/overview/doc/STD-T104v2_00/2_T104/ARIB-STD-T104/Rel11/36/A36305-b30.pdf">http://www.arib.or.jp/english/html/overview/doc/STD-T104v2_00/2_T104/ARIB-STD-T104/Rel11/36/A36305-b30.pdf</a>
ATIS	ATIS.3GPP.36.305V1130-2013	11.3.0	Jun 13	<a href="https://www.atis.org/docstore/default.aspx">https://www.atis.org/docstore/default.aspx</a>
CCSA	CCSA-TSD-LTE-36.305	11.3.0	Apr 15	<a href="http://www.ccsa.org.cn/ITU_spec/ITU-R/M.2012/M.2012-2/LTE/Rel-11/CCSA-TSD-LTE-36305-b30.zip">http://www.ccsa.org.cn/ITU_spec/ITU-R/M.2012/M.2012-2/LTE/Rel-11/CCSA-TSD-LTE-36305-b30.zip</a>
ETSI	ETSI TS 136 305	11.3.0	Apr 13	<a href="http://www.etsi.org/deliver/etsi_ts/136300_136399/136305/11.03.00_60/ts_136305v110300p.pdf">http://www.etsi.org/deliver/etsi_ts/136300_136399/136305/11.03.00_60/ts_136305v110300p.pdf</a>
TTA	TTAT.3G-36.305(R11-11.3.0)	11.3.0	Aug 13	<a href="http://www.tta.or.kr/data/ttasDown.jsp?where=14688&amp;pk_num=TTAT.3G-36.305(R11-11.3.0)">http://www.tta.or.kr/data/ttasDown.jsp?where=14688&amp;pk_num=TTAT.3G-36.305(R11-11.3.0)</a>
TTC	Not applicable			

### Release 12

ARIB	Not applicable			
ATIS	ATIS.3GPP.36.305V1220-2015	12.2.0	May 15	<a href="https://www.atis.org/docstore/default.aspx">https://www.atis.org/docstore/default.aspx</a>
CCSA	CCSA-TSD-LTE-36.305	12.2.0	Apr 15	<a href="http://www.ccsa.org.cn/ITU_spec/ITU-R/M.2012/M.2012-2/LTE/Rel-12/CCSA-TSD-LTE-36305-c20.zip">http://www.ccsa.org.cn/ITU_spec/ITU-R/M.2012/M.2012-2/LTE/Rel-12/CCSA-TSD-LTE-36305-c20.zip</a>
ETSI	ETSI TS 136 305	12.2.0	Feb 15	<a href="http://www.etsi.org/deliver/etsi_ts/136300_136399/136305/12.02.00_60/ts_136305v120200p.pdf">http://www.etsi.org/deliver/etsi_ts/136300_136399/136305/12.02.00_60/ts_136305v120200p.pdf</a>
TTA	TTAT.3G-36.305(R12-12.2.0)	12.2.0	Apr 15	<a href="http://www.tta.or.kr/data/ttasDown.jsp?where=14688&amp;pk_num=TTAT.3G-36.305(R12-12.2.0)">http://www.tta.or.kr/data/ttasDown.jsp?where=14688&amp;pk_num=TTAT.3G-36.305(R12-12.2.0)</a>
TTC	Not applicable			

## 1.2.1.3.5 TS 36.306

### Evolved Universal Terrestrial Radio Access (E-UTRA); User Equipment (UE) radio access capabilities

This document defines the E-UTRA UE Radio Access Capability Parameters.

SDO (2)	Document No.	Version	Issued date	Location (1)
<b>Release 10</b>				
ARIB	ARIB STD-T104-36.306		10.11.0 Mar 14	<a href="http://www.arib.or.jp/english/html/overview/doc/STD-T104v2_30/2_T104/ARIB-STD-T104/Rel10/36/A36306-ab0.pdf">http://www.arib.or.jp/english/html/overview/doc/STD-T104v2_30/2_T104/ARIB-STD-T104/Rel10/36/A36306-ab0.pdf</a>
ATIS	ATIS.3GPP.36.306V10110-2015		10.11.0 May 15	<a href="https://www.atis.org/docstore/default.aspx">https://www.atis.org/docstore/default.aspx</a>
CCSA	CCSA-TSD-LTE-36.306		10.11.0 Apr 15	<a href="http://www.ccsa.org.cn/ITU_spec/ITU-R/M.2012/M.2012-2/LTE/Rel-10/CCSA-TSD-LTE-36306-ab0.zip">http://www.ccsa.org.cn/ITU_spec/ITU-R/M.2012/M.2012-2/LTE/Rel-10/CCSA-TSD-LTE-36306-ab0.zip</a>
ETSI	ETSI TS 136 306		10.11.0 Jan 14	<a href="http://www.etsi.org/deliver/etsi_ts/136300_136399/136306/10.11.00_60/ts_136306v101100p.pdf">http://www.etsi.org/deliver/etsi_ts/136300_136399/136306/10.11.00_60/ts_136306v101100p.pdf</a>
TTC	Not applicable			
<b>Release 11</b>				
ARIB	ARIB STD-T104-36.306		11.9.0 Mar 15	<a href="http://www.arib.or.jp/english/html/overview/doc/STD-T104v2_70/2_T104/ARIB-STD-T104/Rel11/36/A36306-b90.pdf">http://www.arib.or.jp/english/html/overview/doc/STD-T104v2_70/2_T104/ARIB-STD-T104/Rel11/36/A36306-b90.pdf</a>
ATIS	ATIS.3GPP.36.306V1190-2015		11.9.0 May 15	<a href="https://www.atis.org/docstore/default.aspx">https://www.atis.org/docstore/default.aspx</a>
CCSA	CCSA-TSD-LTE-36.306		11.9.0 Apr 15	<a href="http://www.ccsa.org.cn/ITU_spec/ITU-R/M.2012/M.2012-2/LTE/Rel-11/CCSA-TSD-LTE-36306-b90.zip">http://www.ccsa.org.cn/ITU_spec/ITU-R/M.2012/M.2012-2/LTE/Rel-11/CCSA-TSD-LTE-36306-b90.zip</a>
ETSI	ETSI TS 136 306		11.9.0 Feb 15	<a href="http://www.etsi.org/deliver/etsi_ts/136300_136399/136306/11.09.00_60/ts_136306v110900p.pdf">http://www.etsi.org/deliver/etsi_ts/136300_136399/136306/11.09.00_60/ts_136306v110900p.pdf</a>
TTA	TTAT.3G-36.306(R11-11.3.0)		11.3.0 Aug 13	<a href="http://www.tta.or.kr/data/ttasDown.jsp?where=14688&amp;pk_num=TTAT.3G-36.306(R11-11.3.0)">http://www.tta.or.kr/data/ttasDown.jsp?where=14688&amp;pk_num=TTAT.3G-36.306(R11-11.3.0)</a>
TTC	Not applicable			
<b>Release 12</b>				
ARIB	Not applicable			
ATIS	ATIS.3GPP.36.306V1230-2015		12.3.0 May 15	<a href="https://www.atis.org/docstore/default.aspx">https://www.atis.org/docstore/default.aspx</a>
CCSA	CCSA-TSD-LTE-36.306		12.3.0 Apr 15	<a href="http://www.ccsa.org.cn/ITU_spec/ITU-R/M.2012/M.2012-2/LTE/Rel-12/CCSA-TSD-LTE-36306-c30.zip">http://www.ccsa.org.cn/ITU_spec/ITU-R/M.2012/M.2012-2/LTE/Rel-12/CCSA-TSD-LTE-36306-c30.zip</a>
ETSI	ETSI TS 136 306		12.3.0 Feb 15	<a href="http://www.etsi.org/deliver/etsi_ts/136300_136399/136306/12.03.00_60/ts_136306v120300p.pdf">http://www.etsi.org/deliver/etsi_ts/136300_136399/136306/12.03.00_60/ts_136306v120300p.pdf</a>
TTA	TTAT.3G-36.306(R12-12.3.0)		12.3.0 Apr 15	<a href="http://www.tta.or.kr/data/ttasDown.jsp?where=14688&amp;pk_num=TTAT.3G-36.306(R12-12.3.0)">http://www.tta.or.kr/data/ttasDown.jsp?where=14688&amp;pk_num=TTAT.3G-36.306(R12-12.3.0)</a>

TTC Not applicable

**1.2.1.3.6 TS 36.314****Evolved Universal Terrestrial Radio Access (E-UTRA); Layer 2 – Measurements**

This document contains the description and definition of the measurements performed by E-UTRAN that are transferred over the standardized interfaces in order to support E-UTRA radio link operations, radio resource management (RRM), network operations and maintenance (OAM), and self-organizing networks (SON).

SDO (2)	Document No.	Version	Issued date	Location (1)
<b>Release 10</b>				
ARIB	ARIB STD-T104-36.314		10.2.0 Dec 11	<a href="http://www.arib.or.jp/english/html/overview/doc/STD-T104v1_10/2_T104/ARIB-STD-T104/Rel10/36/A36314-a20.pdf">http://www.arib.or.jp/english/html/overview/doc/STD-T104v1_10/2_T104/ARIB-STD-T104/Rel10/36/A36314-a20.pdf</a>
ATIS	ATIS.3GPP.36.314V1020-2013		10.2.0 Jun 13	<a href="https://www.atis.org/docstore/default.aspx">https://www.atis.org/docstore/default.aspx</a>
CCSA	CCSA-TSD-LTE-36.314		10.2.0 Apr 15	<a href="http://www.ccsa.org.cn/ITU_spec/ITU-R/M.2012/M.2012-2/LTE/Rel-10/CCSA-TSD-LTE-36314-a20.zip">http://www.ccsa.org.cn/ITU_spec/ITU-R/M.2012/M.2012-2/LTE/Rel-10/CCSA-TSD-LTE-36314-a20.zip</a>
ETSI	ETSI TS 136 314		10.2.0 Nov 11	<a href="http://www.etsi.org/deliver/etsi_ts/136300_136399/136314/10.02.00_60/ts_136314v100200p.pdf">http://www.etsi.org/deliver/etsi_ts/136300_136399/136314/10.02.00_60/ts_136314v100200p.pdf</a>
TTC	Not applicable			
<b>Release 11</b>				
ARIB	ARIB STD-T104-36.314		11.1.0 Jul 13	<a href="http://www.arib.or.jp/english/html/overview/doc/STD-T104v2_00/2_T104/ARIB-STD-T104/Rel11/36/A36314-b10.pdf">http://www.arib.or.jp/english/html/overview/doc/STD-T104v2_00/2_T104/ARIB-STD-T104/Rel11/36/A36314-b10.pdf</a>
ATIS	ATIS.3GPP.36.314V1110-2013		11.1.0 Jun 13	<a href="https://www.atis.org/docstore/default.aspx">https://www.atis.org/docstore/default.aspx</a>
CCSA	CCSA-TSD-LTE-36.314		11.1.0 Apr 15	<a href="http://www.ccsa.org.cn/ITU_spec/ITU-R/M.2012/M.2012-2/LTE/Rel-11/CCSA-TSD-LTE-36314-b10.zip">http://www.ccsa.org.cn/ITU_spec/ITU-R/M.2012/M.2012-2/LTE/Rel-11/CCSA-TSD-LTE-36314-b10.zip</a>
ETSI	ETSI TS 136 314		11.1.0 Feb 13	<a href="http://www.etsi.org/deliver/etsi_ts/136300_136399/136314/11.01.00_60/ts_136314v110100p.pdf">http://www.etsi.org/deliver/etsi_ts/136300_136399/136314/11.01.00_60/ts_136314v110100p.pdf</a>
TTA	TTAT.3G-36.314(R11-11.1.0)		11.1.0 Aug 13	<a href="http://www.tta.or.kr/data/ttasDown.jsp?where=14688&amp;pk_num=TTAT.3G-36.314(R11-11.1.0)">http://www.tta.or.kr/data/ttasDown.jsp?where=14688&amp;pk_num=TTAT.3G-36.314(R11-11.1.0)</a>
TTC	Not applicable			
<b>Release 12</b>				
ARIB	Not applicable			
ATIS	ATIS.3GPP.36.314V1200-2015		12.0.0 May 15	<a href="https://www.atis.org/docstore/default.aspx">https://www.atis.org/docstore/default.aspx</a>
CCSA	CCSA-TSD-LTE-36.314		12.0.0 Apr 15	<a href="http://www.ccsa.org.cn/ITU_spec/ITU-R/M.2012/M.2012-2/LTE/Rel-12/CCSA-TSD-LTE-36314-c00.zip">http://www.ccsa.org.cn/ITU_spec/ITU-R/M.2012/M.2012-2/LTE/Rel-12/CCSA-TSD-LTE-36314-c00.zip</a>
ETSI	ETSI TS 136 314		12.0.0 Sep 14	<a href="http://www.etsi.org/deliver/etsi_ts/136300_136399/136314/12.00.00_60/ts_136314v120000p.pdf">http://www.etsi.org/deliver/etsi_ts/136300_136399/136314/12.00.00_60/ts_136314v120000p.pdf</a>
TTA	TTAT.3G-36.314(R12-12.0.0)		12.0.0 Apr 15	<a href="http://www.tta.or.kr/data/ttasDown.jsp?where=14688&amp;pk_num=TTAT.3G-36.314(R12-12.0.0)">http://www.tta.or.kr/data/ttasDown.jsp?where=14688&amp;pk_num=TTAT.3G-36.314(R12-12.0.0)</a>
TTC	Not applicable			

### 1.2.1.3.7 TS 36.321

#### Evolved Universal Terrestrial Radio Access (E-UTRA); Medium Access Control (MAC) protocol specification

This document specifies the E-UTRA Medium Access Control(MAC) protocol.

SDO (2)	Document No.	Version	Issued date	Location (1)	
<b>Release 10</b>					
ARIB	ARIB STD-T104-	36.321	10.10.0	Mar 14	<a href="http://www.arib.or.jp/english/html/overview/doc/STD-T104v2_30/2_T104/ARIB-STD-T104/Rel10/36/A36321-aa0.pdf">http://www.arib.or.jp/english/html/overview/doc/STD-T104v2_30/2_T104/ARIB-STD-T104/Rel10/36/A36321-aa0.pdf</a>
ATIS	ATIS.3GPP.36.321V10100-	2015	10.10.0	May 15	<a href="https://www.atis.org/docstore/default.aspx">https://www.atis.org/docstore/default.aspx</a>
CCSA	CCSA-TSD-LTE-36.321		10.10.0	Apr 15	<a href="http://www.ccsa.org.cn/ITU_spec/ITU-R/M.2012/M.2012-2/LTE/Rel-10/CCSA-TSD-LTE-36321-aa0.zip">http://www.ccsa.org.cn/ITU_spec/ITU-R/M.2012/M.2012-2/LTE/Rel-10/CCSA-TSD-LTE-36321-aa0.zip</a>
ETSI	ETSI TS 136 321		10.10.0	Jan 14	<a href="http://www.etsi.org/deliver/etsi_ts/136300_136399/136321/10.10.00_60/ts_136321v101000p.pdf">http://www.etsi.org/deliver/etsi_ts/136300_136399/136321/10.10.00_60/ts_136321v101000p.pdf</a>
TTC	Not applicable				
<b>Release 11</b>					
ARIB	ARIB STD-T104-	36.321	11.5.0	Jul 14	<a href="http://www.arib.or.jp/english/html/overview/doc/STD-T104v2_40/2_T104/ARIB-STD-T104/Rel11/36/A36321-b50.pdf">http://www.arib.or.jp/english/html/overview/doc/STD-T104v2_40/2_T104/ARIB-STD-T104/Rel11/36/A36321-b50.pdf</a>
ATIS	ATIS.3GPP.36.321V1150-	2015	11.5.0	May 15	<a href="https://www.atis.org/docstore/default.aspx">https://www.atis.org/docstore/default.aspx</a>
CCSA	CCSA-TSD-LTE-36.321		11.5.0	Apr 15	<a href="http://www.ccsa.org.cn/ITU_spec/ITU-R/M.2012/M.2012-2/LTE/Rel-11/CCSA-TSD-LTE-36321-b50.zip">http://www.ccsa.org.cn/ITU_spec/ITU-R/M.2012/M.2012-2/LTE/Rel-11/CCSA-TSD-LTE-36321-b50.zip</a>
ETSI	ETSI TS 136 321		11.5.0	Mar 14	<a href="http://www.etsi.org/deliver/etsi_ts/136300_136399/136321/11.05.00_60/ts_136321v110500p.pdf">http://www.etsi.org/deliver/etsi_ts/136300_136399/136321/11.05.00_60/ts_136321v110500p.pdf</a>
TTA	TTAT.3G-36.321(R11-11.2.0)		11.2.0	Aug 13	<a href="http://www.tta.or.kr/data/ttasDown.jsp?where=14688&amp;pk_num=TTAT.3G-36.321(R11-11.2.0)">http://www.tta.or.kr/data/ttasDown.jsp?where=14688&amp;pk_num=TTAT.3G-36.321(R11-11.2.0)</a>
TTC	Not applicable				
<b>Release 12</b>					
ARIB	Not applicable				
ATIS	ATIS.3GPP.36.321V1240-	2015	12.4.0	May 15	<a href="https://www.atis.org/docstore/default.aspx">https://www.atis.org/docstore/default.aspx</a>
CCSA	CCSA-TSD-LTE-36.321		12.4.0	Apr 15	<a href="http://www.ccsa.org.cn/ITU_spec/ITU-R/M.2012/M.2012-2/LTE/Rel-12/CCSA-TSD-LTE-36321-c40.zip">http://www.ccsa.org.cn/ITU_spec/ITU-R/M.2012/M.2012-2/LTE/Rel-12/CCSA-TSD-LTE-36321-c40.zip</a>
ETSI	ETSI TS 136 321		12.4.0	Feb 15	<a href="http://www.etsi.org/deliver/etsi_ts/136300_136399/136321/12.04.00_60/ts_136321v120400p.pdf">http://www.etsi.org/deliver/etsi_ts/136300_136399/136321/12.04.00_60/ts_136321v120400p.pdf</a>
TTA	TTAT.3G-36.321(R12-12.4.0)		12.4.0	Apr 15	<a href="http://www.tta.or.kr/data/ttasDown.jsp?where=14688&amp;pk_num=TTAT.3G-36.321(R12-12.4.0)">http://www.tta.or.kr/data/ttasDown.jsp?where=14688&amp;pk_num=TTAT.3G-36.321(R12-12.4.0)</a>
TTC	Not applicable				

### 1.2.1.3.8 TS 36.322

#### Evolved Universal Terrestrial Radio Access (E-UTRA); Radio Link Control (RLC) protocol specification

This document specifies the E-UTRA Radio Link Control (RLC) protocol.

SDO (2)	Document No.	Version	Issued date	Location (1)	
<b>Release 10</b>					
ARIB	ARIB STD-T104-	36.322	10.0.0	Sep 11	<a href="http://www.arib.or.jp/english/html/overview/doc/STD-T104v1_00/2_T104/ARIB-STD-T104/Rel10/36/A36322-a00.pdf">http://www.arib.or.jp/english/html/overview/doc/STD-T104v1_00/2_T104/ARIB-STD-T104/Rel10/36/A36322-a00.pdf</a>
ATIS	ATIS.3GPP.36.322V1000-	2011	10.0.0	Jul 11	<a href="https://www.atis.org/docstore/default.aspx">https://www.atis.org/docstore/default.aspx</a>
CCSA	CCSA-TSD-LTE-36.322		10.0.0	Apr 15	<a href="http://www.ccsa.org.cn/ITU_spec/ITU-R/M.2012/M.2012-2/LTE/Rel-10/CCSA-TSD-LTE-36322-a00.zip">http://www.ccsa.org.cn/ITU_spec/ITU-R/M.2012/M.2012-2/LTE/Rel-10/CCSA-TSD-LTE-36322-a00.zip</a>
ETSI	ETSI TS 136 322		10.0.0	Jan 11	<a href="http://www.etsi.org/deliver/etsi_ts/136300_136399/136322/10.00.00_60/ts_136322v100000p.pdf">http://www.etsi.org/deliver/etsi_ts/136300_136399/136322/10.00.00_60/ts_136322v100000p.pdf</a>
TTC	Not applicable				
<b>Release 11</b>					
ARIB	ARIB STD-T104-	36.322	11.0.0	Jul 13	<a href="http://www.arib.or.jp/english/html/overview/doc/STD-T104v2_00/2_T104/ARIB-STD-T104/Rel11/36/A36322-b00.pdf">http://www.arib.or.jp/english/html/overview/doc/STD-T104v2_00/2_T104/ARIB-STD-T104/Rel11/36/A36322-b00.pdf</a>
ATIS	ATIS.3GPP.36.322V1100-	2013	11.0.0	Jun 13	<a href="https://www.atis.org/docstore/default.aspx">https://www.atis.org/docstore/default.aspx</a>
CCSA	CCSA-TSD-LTE-36.322		11.0.0	Apr 15	<a href="http://www.ccsa.org.cn/ITU_spec/ITU-R/M.2012/M.2012-2/LTE/Rel-11/CCSA-TSD-LTE-36322-b00.zip">http://www.ccsa.org.cn/ITU_spec/ITU-R/M.2012/M.2012-2/LTE/Rel-11/CCSA-TSD-LTE-36322-b00.zip</a>



ETSI	ETSI TS 136 322	11.0.0	Oct 12	<a href="http://www.etsi.org/deliver/etsi_ts/136300_136399/136322/11.00.00_60/ts_136322v110000p.pdf">http://www.etsi.org/deliver/etsi_ts/136300_136399/136322/11.00.00_60/ts_136322v110000p.pdf</a>
TTA	TTAT.3G-36.322(R11-11.0.0)	11.0.0	Aug 13	<a href="http://www.tta.or.kr/data/ttasDown.jsp?where=14688&amp;pk_num=TTAT.3G-36.322(R11-11.0.0)">http://www.tta.or.kr/data/ttasDown.jsp?where=14688&amp;pk_num=TTAT.3G-36.322(R11-11.0.0)</a>
TTC	Not applicable			

**Release 12**

ARIB	Not applicable			
ATIS	ATIS.3GPP.36.322V1211-2015	12.1.1	May 15	<a href="https://www.atis.org/docstore/default.aspx">https://www.atis.org/docstore/default.aspx</a>
CCSA	CCSA-TSD-LTE-36.322	12.1.0	Apr 15	<a href="http://www.ccsa.org.cn/ITU_spec/ITU-R/M.2012/M.2012-2/LTE/Rel-12/CCSA-TSD-LTE-36322-c10.zip">http://www.ccsa.org.cn/ITU_spec/ITU-R/M.2012/M.2012-2/LTE/Rel-12/CCSA-TSD-LTE-36322-c10.zip</a>
ETSI	ETSI TS 136 322	12.1.1	Feb 15	<a href="http://www.etsi.org/deliver/etsi_ts/136300_136399/136322/12.01.01_60/ts_136322v120101p.pdf">http://www.etsi.org/deliver/etsi_ts/136300_136399/136322/12.01.01_60/ts_136322v120101p.pdf</a>
TTA	TTAT.3G-36.322(R12-12.1.1)	12.1.1	Apr 15	<a href="http://www.tta.or.kr/data/ttasDown.jsp?where=14688&amp;pk_num=TTAT.3G-36.322(R12-12.1.1)">http://www.tta.or.kr/data/ttasDown.jsp?where=14688&amp;pk_num=TTAT.3G-36.322(R12-12.1.1)</a>
TTC	Not applicable			

**1.2.1.3.9 TS 36.323**

**Evolved Universal Terrestrial Radio Access (E-UTRA); Packet Data Convergence Protocol (PDCP) specification**

This document specifies the E-UTRA Packet Data Convergence Protocol (PDCP).

**SDO (2) Document No. Version Issued date Location (1)**

**Release 10**

ARIB	ARIB STD-T104-36.323	10.3.0	Oct 14	<a href="http://www.arib.or.jp/english/html/overview/doc/STD-T104v2_50/2_T104/ARIB-STD-T104/Rel10/36/A36323-a30.pdf">http://www.arib.or.jp/english/html/overview/doc/STD-T104v2_50/2_T104/ARIB-STD-T104/Rel10/36/A36323-a30.pdf</a>
ATIS	ATIS.3GPP.36.323V1030-2015	10.3.0	May 15	<a href="https://www.atis.org/docstore/default.aspx">https://www.atis.org/docstore/default.aspx</a>
CCSA	CCSA-TSD-LTE-36.323	10.3.0	Apr 15	<a href="http://www.ccsa.org.cn/ITU_spec/ITU-R/M.2012/M.2012-2/LTE/Rel-10/CCSA-TSD-LTE-36323-a30.zip">http://www.ccsa.org.cn/ITU_spec/ITU-R/M.2012/M.2012-2/LTE/Rel-10/CCSA-TSD-LTE-36323-a30.zip</a>
ETSI	ETSI TS 136 323	10.3.0	Jul 14	<a href="http://www.etsi.org/deliver/etsi_ts/136300_136399/136323/10.03.00_60/ts_136323v100300p.pdf">http://www.etsi.org/deliver/etsi_ts/136300_136399/136323/10.03.00_60/ts_136323v100300p.pdf</a>
TTC	Not applicable			

**Release 11**

ARIB	ARIB STD-T104-36.323	11.4.0	Dec 14	<a href="http://www.arib.or.jp/english/html/overview/doc/STD-T104v2_60/2_T104/ARIB-STD-T104/Rel11/36/A36323-b40.pdf">http://www.arib.or.jp/english/html/overview/doc/STD-T104v2_60/2_T104/ARIB-STD-T104/Rel11/36/A36323-b40.pdf</a>
ATIS	ATIS.3GPP.36.323V1140-2015	11.4.0	May 15	<a href="https://www.atis.org/docstore/default.aspx">https://www.atis.org/docstore/default.aspx</a>
CCSA	CCSA-TSD-LTE-36.323	11.4.0	Apr 15	<a href="http://www.ccsa.org.cn/ITU_spec/ITU-R/M.2012/M.2012-2/LTE/Rel-11/CCSA-TSD-LTE-36323-b40.zip">http://www.ccsa.org.cn/ITU_spec/ITU-R/M.2012/M.2012-2/LTE/Rel-11/CCSA-TSD-LTE-36323-b40.zip</a>
ETSI	ETSI TS 136 323	11.4.0	Sep 14	<a href="http://www.etsi.org/deliver/etsi_ts/136300_136399/136323/11.04.00_60/ts_136323v110400p.pdf">http://www.etsi.org/deliver/etsi_ts/136300_136399/136323/11.04.00_60/ts_136323v110400p.pdf</a>
TTA	TTAT.3G-36.323(R11-11.2.0)	11.2.0	Aug 13	<a href="http://www.tta.or.kr/data/ttasDown.jsp?where=14688&amp;pk_num=TTAT.3G-36.323(R11-11.2.0)">http://www.tta.or.kr/data/ttasDown.jsp?where=14688&amp;pk_num=TTAT.3G-36.323(R11-11.2.0)</a>
TTC	Not applicable			

**Release 12**

ARIB	Not applicable			
ATIS	ATIS.3GPP.36.323V1220-2015	12.2.0	May 15	<a href="https://www.atis.org/docstore/default.aspx">https://www.atis.org/docstore/default.aspx</a>
CCSA	CCSA-TSD-LTE-36.323	12.2.0	Apr 15	<a href="http://www.ccsa.org.cn/ITU_spec/ITU-R/M.2012/M.2012-2/LTE/Rel-12/CCSA-TSD-LTE-36323-c20.zip">http://www.ccsa.org.cn/ITU_spec/ITU-R/M.2012/M.2012-2/LTE/Rel-12/CCSA-TSD-LTE-36323-c20.zip</a>
ETSI	ETSI TS 136 323	12.2.0	Feb 15	<a href="http://www.etsi.org/deliver/etsi_ts/136300_136399/136323/12.02.00_60/ts_136323v120200p.pdf">http://www.etsi.org/deliver/etsi_ts/136300_136399/136323/12.02.00_60/ts_136323v120200p.pdf</a>
TTA	TTAT.3G-36.323(R12-12.2.0)	12.2.0	Apr 15	<a href="http://www.tta.or.kr/data/ttasDown.jsp?where=14688&amp;pk_num=TTAT.3G-36.323(R12-12.2.0)">http://www.tta.or.kr/data/ttasDown.jsp?where=14688&amp;pk_num=TTAT.3G-36.323(R12-12.2.0)</a>
TTC	Not applicable			

**1.2.1.3.10 TS 36.331****Evolved Universal Terrestrial Radio Access (E-UTRA); Radio Resource Control (RRC); Protocol specification**

This document specifies the Radio Resource Control protocol for the radio interface between UE and E-UTRAN as well as for the radio interface between RN and E-UTRAN. The scope of this document also includes: (i) the radio related information transported in a transparent container between source eNodeB and target eNodeB upon inter eNodeB handover; (ii) the radio related information transported in a transparent container between a source or target eNodeB and another system upon inter RAT handover.

SDO (2)	Document No.	Version	Issued date	Location (1)
<b>Release 10</b>				
ARIB	ARIB STD-T104-36.331		10.15.0 Mar 15	<a href="http://www.arib.or.jp/english/html/overview/doc/STD-T104v2_70/2_T104/ARIB-STD-T104/Rel10/36/A36331-af0.pdf">http://www.arib.or.jp/english/html/overview/doc/STD-T104v2_70/2_T104/ARIB-STD-T104/Rel10/36/A36331-af0.pdf</a>
ATIS	ATIS.3GPP.36.331V10150-2015		10.15.0 May 15	<a href="https://www.atis.org/docstore/default.aspx">https://www.atis.org/docstore/default.aspx</a>
CCSA	CCSA-TSD-LTE-36.331		10.15.0 Apr 15	<a href="http://www.ccsa.org.cn/ITU_spec/ITU-R/M.2012/M.2012-2/LTE/Rel-10/CCSA-TSD-LTE-36331-af0.zip">http://www.ccsa.org.cn/ITU_spec/ITU-R/M.2012/M.2012-2/LTE/Rel-10/CCSA-TSD-LTE-36331-af0.zip</a>
ETSI	ETSI TS 136 331		10.15.0 Feb 15	<a href="http://www.etsi.org/deliver/etsi_ts/136300_136399/136331/10.15.00_60/ts_136331v101500p.pdf">http://www.etsi.org/deliver/etsi_ts/136300_136399/136331/10.15.00_60/ts_136331v101500p.pdf</a>
TTC	Not applicable			
<b>Release 11</b>				
ARIB	ARIB STD-T104-36.331		11.10.0 Mar 15	<a href="http://www.arib.or.jp/english/html/overview/doc/STD-T104v2_70/2_T104/ARIB-STD-T104/Rel11/36/A36331-ba0.pdf">http://www.arib.or.jp/english/html/overview/doc/STD-T104v2_70/2_T104/ARIB-STD-T104/Rel11/36/A36331-ba0.pdf</a>
ATIS	ATIS.3GPP.36.331V11100-2015		11.10.0 May 15	<a href="https://www.atis.org/docstore/default.aspx">https://www.atis.org/docstore/default.aspx</a>
CCSA	CCSA-TSD-LTE-36.331		11.10.0 Apr 15	<a href="http://www.ccsa.org.cn/ITU_spec/ITU-R/M.2012/M.2012-2/LTE/Rel-11/CCSA-TSD-LTE-36331-ba0.zip">http://www.ccsa.org.cn/ITU_spec/ITU-R/M.2012/M.2012-2/LTE/Rel-11/CCSA-TSD-LTE-36331-ba0.zip</a>
ETSI	ETSI TS 136 331		11.10.0 Feb 15	<a href="http://www.etsi.org/deliver/etsi_ts/136300_136399/136331/11.10.00_60/ts_136331v111000p.pdf">http://www.etsi.org/deliver/etsi_ts/136300_136399/136331/11.10.00_60/ts_136331v111000p.pdf</a>
TTA	TTAT.3G-36.331(R11-11.3.0)		11.3.0 Aug 13	<a href="http://www.tta.or.kr/data/ttasDown.jsp?where=14688&amp;pk_num=TTAT.3G-36.331(R11-11.3.0)">http://www.tta.or.kr/data/ttasDown.jsp?where=14688&amp;pk_num=TTAT.3G-36.331(R11-11.3.0)</a>
TTC	Not applicable			
<b>Release 12</b>				
ARIB	Not applicable			
ATIS	ATIS.3GPP.36.331V1241-2015		12.4.1 May 15	<a href="https://www.atis.org/docstore/default.aspx">https://www.atis.org/docstore/default.aspx</a>
CCSA	CCSA-TSD-LTE-36.331		12.4.1 Apr 15	<a href="http://www.ccsa.org.cn/ITU_spec/ITU-R/M.2012/M.2012-2/LTE/Rel-12/CCSA-TSD-LTE-36331-c41.zip">http://www.ccsa.org.cn/ITU_spec/ITU-R/M.2012/M.2012-2/LTE/Rel-12/CCSA-TSD-LTE-36331-c41.zip</a>
ETSI	ETSI TS 136 331		12.4.1 Feb 15	<a href="http://www.etsi.org/deliver/etsi_ts/136300_136399/136331/12.04.01_60/ts_136331v120401p.pdf">http://www.etsi.org/deliver/etsi_ts/136300_136399/136331/12.04.01_60/ts_136331v120401p.pdf</a>
TTA	TTAT.3G-36.331(R12-12.4.1)		12.4.1 Apr 15	<a href="http://www.tta.or.kr/data/ttasDown.jsp?where=14688&amp;pk_num=TTAT.3G-36.331(R12-12.4.1)">http://www.tta.or.kr/data/ttasDown.jsp?where=14688&amp;pk_num=TTAT.3G-36.331(R12-12.4.1)</a>
TTC	Not applicable			

**1.2.1.3.11 TS 36.355****Evolved Universal Terrestrial Radio Access (E-UTRA); LTE Positioning Protocol (LPP)**

This document contains the definition of the LTE Positioning Protocol (LPP).

SDO (2)	Document No.	Version	Issued date	Location (1)
<b>Release 10</b>				
ARIB	ARIB STD-T104-36.355		10.12.0 Oct 14	<a href="http://www.arib.or.jp/english/html/overview/doc/STD-T104v2_50/2_T104/ARIB-STD-T104/Rel10/36/A36355-ac0.pdf">http://www.arib.or.jp/english/html/overview/doc/STD-T104v2_50/2_T104/ARIB-STD-T104/Rel10/36/A36355-ac0.pdf</a>
ATIS	ATIS.3GPP.36.355V10120-2015		10.12.0 May 15	<a href="https://www.atis.org/docstore/default.aspx">https://www.atis.org/docstore/default.aspx</a>
CCSA	CCSA-TSD-LTE-36.355		10.12.0 Apr 15	<a href="http://www.ccsa.org.cn/ITU_spec/ITU-R/M.2012/M.2012-2/LTE/Rel-10/CCSA-TSD-LTE-36355-ac0.zip">http://www.ccsa.org.cn/ITU_spec/ITU-R/M.2012/M.2012-2/LTE/Rel-10/CCSA-TSD-LTE-36355-ac0.zip</a>
ETSI	ETSI TS 136 355		10.12.0 Jul 14	<a href="http://www.etsi.org/deliver/etsi_ts/136300_136399/136355/10.12.00_60/ts_136355v101200p.pdf">http://www.etsi.org/deliver/etsi_ts/136300_136399/136355/10.12.00_60/ts_136355v101200p.pdf</a>
TTC	Not applicable			

**Release 11**

ARIB	ARIB STD-T104-36.355	11.6.0	Oct 14	<a href="http://www.arib.or.jp/english/html/overview/doc/STD-T104v2_50/2_T104/ARIB-STD-T104/Rel11/36/A36355-b60.pdf">http://www.arib.or.jp/english/html/overview/doc/STD-T104v2_50/2_T104/ARIB-STD-T104/Rel11/36/A36355-b60.pdf</a>
ATIS	ATIS.3GPP.36.355V1160-2015	11.6.0	May 15	<a href="https://www.atis.org/docstore/default.aspx">https://www.atis.org/docstore/default.aspx</a>
CCSA	CCSA-TSD-LTE-36.355	11.6.0	Apr 15	<a href="http://www.ccsa.org.cn/ITU_spec/ITU-R/M.2012/M.2012-2/LTE/Rel-11/CCSA-TSD-LTE-36355-b60.zip">http://www.ccsa.org.cn/ITU_spec/ITU-R/M.2012/M.2012-2/LTE/Rel-11/CCSA-TSD-LTE-36355-b60.zip</a>
ETSI	ETSI TS 136 355	11.6.0	Jul 14	<a href="http://www.etsi.org/deliver/etsi_ts/136300_136399/136355/11.06.00_60/ts_136355v110600p.pdf">http://www.etsi.org/deliver/etsi_ts/136300_136399/136355/11.06.00_60/ts_136355v110600p.pdf</a>
TTA	TTAT.3G-36.355(R11-11.2.0)	11.2.0	Aug 13	<a href="http://www.tta.or.kr/data/ttasDown.jsp?where=14688&amp;pk_num=TTAT.3G-36.355(R11-11.2.0)">http://www.tta.or.kr/data/ttasDown.jsp?where=14688&amp;pk_num=TTAT.3G-36.355(R11-11.2.0)</a>
TTC	Not applicable			

**Release 12**

ARIB	Not applicable			
ATIS	ATIS.3GPP.36.355V1230-2015	12.3.0	May 15	<a href="https://www.atis.org/docstore/default.aspx">https://www.atis.org/docstore/default.aspx</a>
CCSA	CCSA-TSD-LTE-36.355	12.3.0	Apr 15	<a href="http://www.ccsa.org.cn/ITU_spec/ITU-R/M.2012/M.2012-2/LTE/Rel-12/CCSA-TSD-LTE-36355-c30.zip">http://www.ccsa.org.cn/ITU_spec/ITU-R/M.2012/M.2012-2/LTE/Rel-12/CCSA-TSD-LTE-36355-c30.zip</a>
ETSI	ETSI TS 136 355	12.3.0	Feb 15	<a href="http://www.etsi.org/deliver/etsi_ts/136300_136399/136355/12.03.00_60/ts_136355v120300p.pdf">http://www.etsi.org/deliver/etsi_ts/136300_136399/136355/12.03.00_60/ts_136355v120300p.pdf</a>
TTA	TTAT.3G-36.355(R12-12.3.0)	12.3.0	Apr 15	<a href="http://www.tta.or.kr/data/ttasDown.jsp?where=14688&amp;pk_num=TTAT.3G-36.355(R12-12.3.0)">http://www.tta.or.kr/data/ttasDown.jsp?where=14688&amp;pk_num=TTAT.3G-36.355(R12-12.3.0)</a>
TTC	Not applicable			

**1.2.1.4 Architecture****1.2.1.4.1 TS 36.401****Evolved Universal Terrestrial Radio Access Network (E-UTRAN); Architecture description**

This document describes the overall architecture of the E-UTRAN, including internal interfaces and assumptions on the radio, S1 and X2 interfaces.

SDO (2)	Document No.	Version	Issued date	Location (1)
<b>Release 10</b>				
ARIB	Not applicable			
ATIS	ATIS.3GPP.36.401V1040-2013	10.4.0	Jun 13	<a href="https://www.atis.org/docstore/default.aspx">https://www.atis.org/docstore/default.aspx</a>
CCSA	CCSA-TSD-LTE-36.401	10.4.0	Apr 15	<a href="http://www.ccsa.org.cn/ITU_spec/ITU-R/M.2012/M.2012-2/LTE/Rel-10/CCSA-TSD-LTE-36401-a40.zip">http://www.ccsa.org.cn/ITU_spec/ITU-R/M.2012/M.2012-2/LTE/Rel-10/CCSA-TSD-LTE-36401-a40.zip</a>
ETSI	ETSI TS 136 401	10.4.0	Jul 12	<a href="http://www.etsi.org/deliver/etsi_ts/136400_136499/136401/10.04.00_60/ts_136401v100400p.pdf">http://www.etsi.org/deliver/etsi_ts/136400_136499/136401/10.04.00_60/ts_136401v100400p.pdf</a>
TTC	TS-3GA-36.401(Rel10)v10.4.0	10.4.0	Sep 12	<a href="http://www.ttc.or.jp/jp/document_list/free/3gpps2012/TS/TS-3GA-36.401(Rel10)v10.4.0.pdf">http://www.ttc.or.jp/jp/document_list/free/3gpps2012/TS/TS-3GA-36.401(Rel10)v10.4.0.pdf</a>
<b>Release 11</b>				
ARIB	Not applicable			
ATIS	ATIS.3GPP.36.401V1120-2015	11.2.0	May 15	<a href="https://www.atis.org/docstore/default.aspx">https://www.atis.org/docstore/default.aspx</a>
CCSA	CCSA-TSD-LTE-36.401	11.2.0	Apr 15	<a href="http://www.ccsa.org.cn/ITU_spec/ITU-R/M.2012/M.2012-2/LTE/Rel-11/CCSA-TSD-LTE-36401-b20.zip">http://www.ccsa.org.cn/ITU_spec/ITU-R/M.2012/M.2012-2/LTE/Rel-11/CCSA-TSD-LTE-36401-b20.zip</a>
ETSI	ETSI TS 136 401	11.2.0	Sep 13	<a href="http://www.etsi.org/deliver/etsi_ts/136400_136499/136401/11.02.00_60/ts_136401v110200p.pdf">http://www.etsi.org/deliver/etsi_ts/136400_136499/136401/11.02.00_60/ts_136401v110200p.pdf</a>
TTA	TTAT.3G-36.401(R11-11.1.0)	11.1.0	Aug 13	<a href="http://www.tta.or.kr/data/ttasDown.jsp?where=14688&amp;pk_num=TTAT.3G-36.401(R11-11.1.0)">http://www.tta.or.kr/data/ttasDown.jsp?where=14688&amp;pk_num=TTAT.3G-36.401(R11-11.1.0)</a>
TTC	TS-3GA-36.401(Rel11)v11.2.0	11.2.0	Dec 13	<a href="http://www.ttc.or.jp/jp/document_list/free/3gpps2013/TS/TS-3GA-36.401(Rel11)v11.2.0.pdf">http://www.ttc.or.jp/jp/document_list/free/3gpps2013/TS/TS-3GA-36.401(Rel11)v11.2.0.pdf</a>
<b>Release 12</b>				
ARIB	Not applicable			
ATIS	ATIS.3GPP.36.401V1210-2015	12.1.0	May 15	<a href="https://www.atis.org/docstore/default.aspx">https://www.atis.org/docstore/default.aspx</a>
CCSA	CCSA-TSD-LTE-36.401	12.1.0	Apr 15	<a href="http://www.ccsa.org.cn/ITU_spec/ITU-R/M.2012/M.2012-2/LTE/Rel-12/CCSA-TSD-LTE-36401-c10.zip">http://www.ccsa.org.cn/ITU_spec/ITU-R/M.2012/M.2012-2/LTE/Rel-12/CCSA-TSD-LTE-36401-c10.zip</a>
ETSI	ETSI TS 136 401	12.1.0	Feb 15	<a href="http://www.etsi.org/deliver/etsi_ts/136400_136499/136401/12.01.00_60/ts_136401v120100p.pdf">http://www.etsi.org/deliver/etsi_ts/136400_136499/136401/12.01.00_60/ts_136401v120100p.pdf</a>
TTA	TTAT.3G-36.401(R12-12.1.0)	12.1.0	Apr 15	<a href="http://www.tta.or.kr/data/ttasDown.jsp?where=14688&amp;pk_num=TTAT.3G-36.401(R12-12.1.0)">http://www.tta.or.kr/data/ttasDown.jsp?where=14688&amp;pk_num=TTAT.3G-36.401(R12-12.1.0)</a>
TTC	TS-3GA-36.401(Rel12)v12.1.0	12.1.0	Mar 15	<a href="http://www.ttc.or.jp/jp/document_list/free/3gpps2015/TS/TS-3GA-36.401(Rel12)v12.1.0.pdf">http://www.ttc.or.jp/jp/document_list/free/3gpps2015/TS/TS-3GA-36.401(Rel12)v12.1.0.pdf</a>

### 1.2.1.4.2 TS 36.410

#### Evolved Universal Terrestrial Radio Access Network (E-UTRAN); S1 layer 1 general aspects and principles

This document is an introduction to the 3GPP TS 36.41x series of technical specifications that define the S1 interface for the interconnection of the eNodeB component of the Evolved Universal Terrestrial Radio Access Network (E UTRAN) to the Core Network of the EPS system.

SDO (2)	Document No.	Version	Issued date		Location (1)
<b>Release 10</b>					
ARIB	Not applicable				
ATIS	ATIS.3GPP.36.410V1030-2013		10.3.0	Jun 13	<a href="https://www.atis.org/docstore/default.aspx">https://www.atis.org/docstore/default.aspx</a>
CCSA	CCSA-TSD-LTE-36.410		10.3.0	Apr 15	<a href="http://www.ccsa.org.cn/ITU_spec/ITU-R/M.2012/M.2012-2/LTE/Rel-10/CCSA-TSD-LTE-36410-a30.zip">http://www.ccsa.org.cn/ITU_spec/ITU-R/M.2012/M.2012-2/LTE/Rel-10/CCSA-TSD-LTE-36410-a30.zip</a>
ETSI	ETSI TS 136 410		10.3.0	Jul 12	<a href="http://www.etsi.org/deliver/etsi_ts/136400_136499/136410/10.03.00_60/ts_136410v100300p.pdf">http://www.etsi.org/deliver/etsi_ts/136400_136499/136410/10.03.00_60/ts_136410v100300p.pdf</a>
TTC	TS-3GA-36.410(Rel10)v10.3.0		10.3.0	Sep 12	<a href="http://www.ttc.or.jp/jp/document_list/free/3gpps2012/TS/TS-3GA-36.410(Rel10)v10.3.0.pdf">http://www.ttc.or.jp/jp/document_list/free/3gpps2012/TS/TS-3GA-36.410(Rel10)v10.3.0.pdf</a>
<b>Release 11</b>					
ARIB	Not applicable				
ATIS	ATIS.3GPP.36.410V1110-2015		11.1.0	May 15	<a href="https://www.atis.org/docstore/default.aspx">https://www.atis.org/docstore/default.aspx</a>
CCSA	CCSA-TSD-LTE-36.410		11.1.0	Apr 15	<a href="http://www.ccsa.org.cn/ITU_spec/ITU-R/M.2012/M.2012-2/LTE/Rel-11/CCSA-TSD-LTE-36410-b10.zip">http://www.ccsa.org.cn/ITU_spec/ITU-R/M.2012/M.2012-2/LTE/Rel-11/CCSA-TSD-LTE-36410-b10.zip</a>
ETSI	ETSI TS 136 410		11.1.0	Sep 13	<a href="http://www.etsi.org/deliver/etsi_ts/136400_136499/136410/11.01.00_60/ts_136410v110100p.pdf">http://www.etsi.org/deliver/etsi_ts/136400_136499/136410/11.01.00_60/ts_136410v110100p.pdf</a>
TTA	TTAT.3G-36.410(R11-11.0.0)		11.0.0	Aug 13	<a href="http://www.tta.or.kr/data/ttasDown.jsp?where=14688&amp;pk_num=TTAT.3G-36.410(R11-11.0.0)">http://www.tta.or.kr/data/ttasDown.jsp?where=14688&amp;pk_num=TTAT.3G-36.410(R11-11.0.0)</a>
TTC	TS-3GA-36.410(Rel11)v11.1.0		11.1.0	Dec 13	<a href="http://www.ttc.or.jp/jp/document_list/free/3gpps2013/TS/TS-3GA-36.410(Rel11)v11.1.0.pdf">http://www.ttc.or.jp/jp/document_list/free/3gpps2013/TS/TS-3GA-36.410(Rel11)v11.1.0.pdf</a>
<b>Release 12</b>					
ARIB	Not applicable				
ATIS	ATIS.3GPP.36.410V1210-2015		12.1.0	May 15	<a href="https://www.atis.org/docstore/default.aspx">https://www.atis.org/docstore/default.aspx</a>
CCSA	CCSA-TSD-LTE-36.410		12.1.0	Apr 15	<a href="http://www.ccsa.org.cn/ITU_spec/ITU-R/M.2012/M.2012-2/LTE/Rel-12/CCSA-TSD-LTE-36410-c10.zip">http://www.ccsa.org.cn/ITU_spec/ITU-R/M.2012/M.2012-2/LTE/Rel-12/CCSA-TSD-LTE-36410-c10.zip</a>
ETSI	ETSI TS 136 410		12.1.0	Feb 15	<a href="http://www.etsi.org/deliver/etsi_ts/136400_136499/136410/12.01.00_60/ts_136410v120100p.pdf">http://www.etsi.org/deliver/etsi_ts/136400_136499/136410/12.01.00_60/ts_136410v120100p.pdf</a>
TTA	TTAT.3G-36.410(R12-12.1.0)		12.1.0	Apr 15	<a href="http://www.tta.or.kr/data/ttasDown.jsp?where=14688&amp;pk_num=TTAT.3G-36.410(R12-12.1.0)">http://www.tta.or.kr/data/ttasDown.jsp?where=14688&amp;pk_num=TTAT.3G-36.410(R12-12.1.0)</a>
TTC	TS-3GA-36.410(Rel12)v12.1.0		12.1.0	Mar 15	<a href="http://www.ttc.or.jp/jp/document_list/free/3gpps2015/TS/TS-3GA-36.410(Rel12)v12.1.0.pdf">http://www.ttc.or.jp/jp/document_list/free/3gpps2015/TS/TS-3GA-36.410(Rel12)v12.1.0.pdf</a>

### 1.2.1.4.3 TS 36.411

#### Evolved Universal Terrestrial Radio Access Network (E-UTRAN); S1 layer 1

This document specifies the standards allowed to implement layer 1 on the S1 interface. The specification of transmission delay requirements and O&M requirements are not in the scope of this document. In the following, “layer 1” and “physical layer” are assumed to be synonymous.

SDO (2)	Document No.	Version	Issued date		Location (1)
<b>Release 10</b>					
ARIB	Not applicable				
ATIS	ATIS.3GPP.36.411V1010-2011		10.1.0	Jul 11	<a href="https://www.atis.org/docstore/default.aspx">https://www.atis.org/docstore/default.aspx</a>
CCSA	CCSA-TSD-LTE-36.411		10.1.0	Apr 15	<a href="http://www.ccsa.org.cn/ITU_spec/ITU-R/M.2012/M.2012-2/LTE/Rel-10/CCSA-TSD-LTE-36411-a10.zip">http://www.ccsa.org.cn/ITU_spec/ITU-R/M.2012/M.2012-2/LTE/Rel-10/CCSA-TSD-LTE-36411-a10.zip</a>
ETSI	ETSI TS 136 411		10.1.0	Jun 11	<a href="http://www.etsi.org/deliver/etsi_ts/136400_136499/136411/10.01.00_60/ts_136411v100100p.pdf">http://www.etsi.org/deliver/etsi_ts/136400_136499/136411/10.01.00_60/ts_136411v100100p.pdf</a>
TTC	TS-3GA-36.411(Rel10)v10.1.0		10.1.0	Jun 11	<a href="http://www.ttc.or.jp/jp/document_list/free/3gpps2011/TS/TS-3GA-36.411(Rel10)v10.1.0.pdf">http://www.ttc.or.jp/jp/document_list/free/3gpps2011/TS/TS-3GA-36.411(Rel10)v10.1.0.pdf</a>

**Release 11**

ARIB	Not applicable				
ATIS	ATIS.3GPP.36.411V1100-2013	11.0.0	Jun 13	<a href="https://www.atis.org/docstore/default.aspx">https://www.atis.org/docstore/default.aspx</a>	
CCSA	CCSA-TSD-LTE-36.411	11.0.0	Apr 15	<a href="http://www.ccsa.org.cn/ITU_spec/ITU-R/M.2012/M.2012-2/LTE/Rel-11/CCSA-TSD-LTE-36411-b00.zip">http://www.ccsa.org.cn/ITU_spec/ITU-R/M.2012/M.2012-2/LTE/Rel-11/CCSA-TSD-LTE-36411-b00.zip</a>	
ETSI	ETSI TS 136 411	11.0.0	Oct 12	<a href="http://www.etsi.org/deliver/etsi_ts/136400_136499/136411/11.00.00_60/ts_136411v110000p.pdf">http://www.etsi.org/deliver/etsi_ts/136400_136499/136411/11.00.00_60/ts_136411v110000p.pdf</a>	
TTA	TTAT.3G-36.411(R11-11.0.0)	11.0.0	Aug 13	<a href="http://www.tta.or.kr/data/ttasDown.jsp?where=14688&amp;pk_num=TTAT.3G-36.411(R11-11.0.0)">http://www.tta.or.kr/data/ttasDown.jsp?where=14688&amp;pk_num=TTAT.3G-36.411(R11-11.0.0)</a>	
TTC	TS-3GA-36.411(Rel11)v11.0.0	11.0.0	Jun 13	<a href="http://www.ttc.or.jp/jp/document_list/free/3gpps2013/TS/TS-3GA-36.411(Rel11)v11.0.0.pdf">http://www.ttc.or.jp/jp/document_list/free/3gpps2013/TS/TS-3GA-36.411(Rel11)v11.0.0.pdf</a>	

**Release 12**

ARIB	Not applicable			
ATIS	ATIS.3GPP.36.411V1200-2015	12.0.0	May 15	<a href="https://www.atis.org/docstore/default.aspx">https://www.atis.org/docstore/default.aspx</a>
CCSA	CCSA-TSD-LTE-36.411	12.0.0	Apr 15	<a href="http://www.ccsa.org.cn/ITU_spec/ITU-R/M.2012/M.2012-2/LTE/Rel-12/CCSA-TSD-LTE-36411-c00.zip">http://www.ccsa.org.cn/ITU_spec/ITU-R/M.2012/M.2012-2/LTE/Rel-12/CCSA-TSD-LTE-36411-c00.zip</a>
ETSI	ETSI TS 136 411	12.0.0	Sep 14	<a href="http://www.etsi.org/deliver/etsi_ts/136400_136499/136411/12.00.00_60/ts_136411v120000p.pdf">http://www.etsi.org/deliver/etsi_ts/136400_136499/136411/12.00.00_60/ts_136411v120000p.pdf</a>
TTA	TTAT.3G-36.411(R12-12.0.0)	12.0.0	Apr 15	<a href="http://www.tta.or.kr/data/ttasDown.jsp?where=14688&amp;pk_num=TTAT.3G-36.411(R12-12.0.0)">http://www.tta.or.kr/data/ttasDown.jsp?where=14688&amp;pk_num=TTAT.3G-36.411(R12-12.0.0)</a>
TTC	TS-3GA-36.411(Rel12)v12.0.0	12.0.0	Mar 15	<a href="http://www.ttc.or.jp/jp/document_list/free/3gpps2015/TS/TS-3GA-36.411(Rel12)v12.0.0.pdf">http://www.ttc.or.jp/jp/document_list/free/3gpps2015/TS/TS-3GA-36.411(Rel12)v12.0.0.pdf</a>

**1.2.1.4.4 TS 36.412****Evolved Universal Terrestrial Radio Access Network (E-UTRAN); S1 signalling transport**

This document specifies the standards for signalling transport to be used across S1 interface. S1 interface is a logical interface between the eNodeB and the E-UTRAN core network. This document describes how the S1-AP signalling messages are transported over S1.

**SDO (2) Document No. Version Issued date Location (1)****Release 10**

ARIB	Not applicable			
ATIS	ATIS.3GPP.36.412V1010-2011	10.1.0	Jul 11	<a href="https://www.atis.org/docstore/default.aspx">https://www.atis.org/docstore/default.aspx</a>
CCSA	CCSA-TSD-LTE-36.412	10.1.0	Apr 15	<a href="http://www.ccsa.org.cn/ITU_spec/ITU-R/M.2012/M.2012-2/LTE/Rel-10/CCSA-TSD-LTE-36412-a10.zip">http://www.ccsa.org.cn/ITU_spec/ITU-R/M.2012/M.2012-2/LTE/Rel-10/CCSA-TSD-LTE-36412-a10.zip</a>
ETSI	ETSI TS 136 412	10.1.0	Jun 11	<a href="http://www.etsi.org/deliver/etsi_ts/136400_136499/136412/10.01.00_60/ts_136412v100100p.pdf">http://www.etsi.org/deliver/etsi_ts/136400_136499/136412/10.01.00_60/ts_136412v100100p.pdf</a>
TTC	TS-3GA-36.412(Rel10)v10.1.0	10.1.0	Jun 11	<a href="http://www.ttc.or.jp/jp/document_list/free/3gpps2011/TS/TS-3GA-36.412(Rel10)v10.1.0.pdf">http://www.ttc.or.jp/jp/document_list/free/3gpps2011/TS/TS-3GA-36.412(Rel10)v10.1.0.pdf</a>

**Release 11**

ARIB	Not applicable			
ATIS	ATIS.3GPP.36.412V1100-2013	11.0.0	Jun 13	<a href="https://www.atis.org/docstore/default.aspx">https://www.atis.org/docstore/default.aspx</a>
CCSA	CCSA-TSD-LTE-36.412	11.0.0	Apr 15	<a href="http://www.ccsa.org.cn/ITU_spec/ITU-R/M.2012/M.2012-2/LTE/Rel-11/CCSA-TSD-LTE-36412-b00.zip">http://www.ccsa.org.cn/ITU_spec/ITU-R/M.2012/M.2012-2/LTE/Rel-11/CCSA-TSD-LTE-36412-b00.zip</a>
ETSI	ETSI TS 136 412	11.0.0	Oct 12	<a href="http://www.etsi.org/deliver/etsi_ts/136400_136499/136412/11.00.00_60/ts_136412v110000p.pdf">http://www.etsi.org/deliver/etsi_ts/136400_136499/136412/11.00.00_60/ts_136412v110000p.pdf</a>
TTA	TTAT.3G-36.412(R11-11.0.0)	11.0.0	Aug 13	<a href="http://www.tta.or.kr/data/ttasDown.jsp?where=14688&amp;pk_num=TTAT.3G-36.412(R11-11.0.0)">http://www.tta.or.kr/data/ttasDown.jsp?where=14688&amp;pk_num=TTAT.3G-36.412(R11-11.0.0)</a>
TTC	TS-3GA-36.412(Rel11)v11.0.0	11.0.0	Jun 13	<a href="http://www.ttc.or.jp/jp/document_list/free/3gpps2013/TS/TS-3GA-36.412(Rel11)v11.0.0.pdf">http://www.ttc.or.jp/jp/document_list/free/3gpps2013/TS/TS-3GA-36.412(Rel11)v11.0.0.pdf</a>

**Release 12**

ARIB	Not applicable			
ATIS	ATIS.3GPP.36.412V1200-2015	12.0.0	May 15	<a href="https://www.atis.org/docstore/default.aspx">https://www.atis.org/docstore/default.aspx</a>
CCSA	CCSA-TSD-LTE-36.412	12.0.0	Apr 15	<a href="http://www.ccsa.org.cn/ITU_spec/ITU-R/M.2012/M.2012-2/LTE/Rel-12/CCSA-TSD-LTE-36412-c00.zip">http://www.ccsa.org.cn/ITU_spec/ITU-R/M.2012/M.2012-2/LTE/Rel-12/CCSA-TSD-LTE-36412-c00.zip</a>
ETSI	ETSI TS 136 412	12.0.0	Sep 14	<a href="http://www.etsi.org/deliver/etsi_ts/136400_136499/136412/12.00.00_60/ts_136412v120000p.pdf">http://www.etsi.org/deliver/etsi_ts/136400_136499/136412/12.00.00_60/ts_136412v120000p.pdf</a>
TTA	TTAT.3G-36.412(R12-12.0.0)	12.0.0	Apr 15	<a href="http://www.tta.or.kr/data/ttasDown.jsp?where=14688&amp;pk_num=TTAT.3G-36.412(R12-12.0.0)">http://www.tta.or.kr/data/ttasDown.jsp?where=14688&amp;pk_num=TTAT.3G-36.412(R12-12.0.0)</a>
TTC	TS-3GA-36.412(Rel12)v12.0.0	12.0.0	Mar 15	<a href="http://www.ttc.or.jp/jp/document_list/free/3gpps2015/TS/TS-3GA-36.412(Rel12)v12.0.0.pdf">http://www.ttc.or.jp/jp/document_list/free/3gpps2015/TS/TS-3GA-36.412(Rel12)v12.0.0.pdf</a>

### 1.2.1.4.5 TS 36.413

#### Evolved Universal Terrestrial Radio Access Network (E-UTRAN); S1 Application Protocol (S1AP)

This document specifies the E-UTRAN radio network layer signalling protocol for the S1 interface. The S1 Application Protocol (S1AP) supports the functions of S1 interface by signalling procedures defined in this document.

SDO (2)	Document No.	Version	Issued date	Location (1)
<b>Release 10</b>				
ARIB	Not applicable			
ATIS	ATIS.3GPP.36.413V1090-2015	10.9.0	May 15	<a href="https://www.atis.org/docstore/default.aspx">https://www.atis.org/docstore/default.aspx</a>
CCSA	CCSA-TSD-LTE-36.413	10.9.0	Apr 15	<a href="http://www.ccsa.org.cn/ITU_spec/ITU-R/M.2012/M.2012-2/LTE/Rel-10/CCSA-TSD-LTE-36413-a90.zip">http://www.ccsa.org.cn/ITU_spec/ITU-R/M.2012/M.2012-2/LTE/Rel-10/CCSA-TSD-LTE-36413-a90.zip</a>
ETSI	ETSI TS 136 413	10.9.0	Sep 14	<a href="http://www.etsi.org/deliver/etsi_ts/136400_136499/136413/10.09.00_60/ts_136413v100900p.pdf">http://www.etsi.org/deliver/etsi_ts/136400_136499/136413/10.09.00_60/ts_136413v100900p.pdf</a>
TTC	TS-3GA-36.413(Rel10)v10.9.0	10.9.0	Dec 14	<a href="http://www.ttc.or.jp/jp/document_list/free/3gpps2014/TS/TS-3GA-36.413(Rel10)v10.9.0.pdf">http://www.ttc.or.jp/jp/document_list/free/3gpps2014/TS/TS-3GA-36.413(Rel10)v10.9.0.pdf</a>
<b>Release 11</b>				
ARIB	Not applicable			
ATIS	ATIS.3GPP.36.413V1180-2015	11.8.0	May 15	<a href="https://www.atis.org/docstore/default.aspx">https://www.atis.org/docstore/default.aspx</a>
CCSA	CCSA-TSD-LTE-36.413	11.8.0	Apr 15	<a href="http://www.ccsa.org.cn/ITU_spec/ITU-R/M.2012/M.2012-2/LTE/Rel-11/CCSA-TSD-LTE-36413-b80.zip">http://www.ccsa.org.cn/ITU_spec/ITU-R/M.2012/M.2012-2/LTE/Rel-11/CCSA-TSD-LTE-36413-b80.zip</a>
ETSI	ETSI TS 136 413	11.8.0	Sep 14	<a href="http://www.etsi.org/deliver/etsi_ts/136400_136499/136413/11.08.00_60/ts_136413v110800p.pdf">http://www.etsi.org/deliver/etsi_ts/136400_136499/136413/11.08.00_60/ts_136413v110800p.pdf</a>
TTA	TTAT.3G-36.413(R11-11.3.0)	11.3.0	Aug 13	<a href="http://www.tta.or.kr/data/ttasDown.jsp?where=14688&amp;pk_num=TTAT.3G-36.413(R11-11.3.0)">http://www.tta.or.kr/data/ttasDown.jsp?where=14688&amp;pk_num=TTAT.3G-36.413(R11-11.3.0)</a>
TTC	TS-3GA-36.413(Rel11)v11.8.0	11.8.0	Dec 14	<a href="http://www.ttc.or.jp/jp/document_list/free/3gpps2014/TS/TS-3GA-36.413(Rel11)v11.8.0.pdf">http://www.ttc.or.jp/jp/document_list/free/3gpps2014/TS/TS-3GA-36.413(Rel11)v11.8.0.pdf</a>
<b>Release 12</b>				
ARIB	Not applicable			
ATIS	ATIS.3GPP.36.413V1240-2015	12.4.0	May 15	<a href="https://www.atis.org/docstore/default.aspx">https://www.atis.org/docstore/default.aspx</a>
CCSA	CCSA-TSD-LTE-36.413	12.4.0	Apr 15	<a href="http://www.ccsa.org.cn/ITU_spec/ITU-R/M.2012/M.2012-2/LTE/Rel-12/CCSA-TSD-LTE-36413-c40.zip">http://www.ccsa.org.cn/ITU_spec/ITU-R/M.2012/M.2012-2/LTE/Rel-12/CCSA-TSD-LTE-36413-c40.zip</a>
ETSI	ETSI TS 136 413	12.4.0	Feb 15	<a href="http://www.etsi.org/deliver/etsi_ts/136400_136499/136413/12.04.00_60/ts_136413v120400p.pdf">http://www.etsi.org/deliver/etsi_ts/136400_136499/136413/12.04.00_60/ts_136413v120400p.pdf</a>
TTA	TTAT.3G-36.413(R12-12.4.0)	12.4.0	Apr 15	<a href="http://www.tta.or.kr/data/ttasDown.jsp?where=14688&amp;pk_num=TTAT.3G-36.413(R12-12.4.0)">http://www.tta.or.kr/data/ttasDown.jsp?where=14688&amp;pk_num=TTAT.3G-36.413(R12-12.4.0)</a>
TTC	TS-3GA-36.413(Rel12)v12.4.0	12.4.0	Mar 15	<a href="http://www.ttc.or.jp/jp/document_list/free/3gpps2015/TS/TS-3GA-36.413(Rel12)v12.4.0.pdf">http://www.ttc.or.jp/jp/document_list/free/3gpps2015/TS/TS-3GA-36.413(Rel12)v12.4.0.pdf</a>

### 1.2.1.4.6 TS 36.414

#### Evolved Universal Terrestrial Radio Access Network (E-UTRAN); S1 data transport

This document specifies the standards for user data transport protocols and related signalling protocols to establish user plane transport bearers over the S1 interface.

SDO (2)	Document No.	Version	Issued date	Location (1)
<b>Release 10</b>				
ARIB	Not applicable			
ATIS	ATIS.3GPP.36.414V1010-2011	10.1.0	Jul 11	<a href="https://www.atis.org/docstore/default.aspx">https://www.atis.org/docstore/default.aspx</a>
CCSA	CCSA-TSD-LTE-36.414	10.1.0	Apr 15	<a href="http://www.ccsa.org.cn/ITU_spec/ITU-R/M.2012/M.2012-2/LTE/Rel-10/CCSA-TSD-LTE-36414-a10.zip">http://www.ccsa.org.cn/ITU_spec/ITU-R/M.2012/M.2012-2/LTE/Rel-10/CCSA-TSD-LTE-36414-a10.zip</a>
ETSI	ETSI TS 136 414	10.1.0	Jun 11	<a href="http://www.etsi.org/deliver/etsi_ts/136400_136499/136414/10.01.00_60/ts_136414v100100p.pdf">http://www.etsi.org/deliver/etsi_ts/136400_136499/136414/10.01.00_60/ts_136414v100100p.pdf</a>
TTC	TS-3GA-36.414(Rel10)v10.1.0	10.1.0	Jun 11	<a href="http://www.ttc.or.jp/jp/document_list/free/3gpps2011/TS/TS-3GA-36.414(Rel10)v10.1.0.pdf">http://www.ttc.or.jp/jp/document_list/free/3gpps2011/TS/TS-3GA-36.414(Rel10)v10.1.0.pdf</a>

**Release 11**

ARIB	Not applicable				
ATIS	ATIS.3GPP.36.414V1100-2013	11.0.0	Jun 13	<a href="https://www.atis.org/docstore/default.aspx">https://www.atis.org/docstore/default.aspx</a>	
CCSA	CCSA-TSD-LTE-36.414	11.0.0	Apr 15	<a href="http://www.ccsa.org.cn/ITU_spec/ITU-R/M.2012/M.2012-2/LTE/Rel-11/CCSA-TSD-LTE-36414-b00.zip">http://www.ccsa.org.cn/ITU_spec/ITU-R/M.2012/M.2012-2/LTE/Rel-11/CCSA-TSD-LTE-36414-b00.zip</a>	
ETSI	ETSI TS 136 414	11.0.0	Oct 12	<a href="http://www.etsi.org/deliver/etsi_ts/136400_136499/136414/11.00.00_60/ts_136414v110000p.pdf">http://www.etsi.org/deliver/etsi_ts/136400_136499/136414/11.00.00_60/ts_136414v110000p.pdf</a>	
TTA	TTAT.3G-36.414(R11-11.0.0)	11.0.0	Aug 13	<a href="http://www.tta.or.kr/data/ttasDown.jsp?where=14688&amp;pk_num=TTAT.3G-36.414(R11-11.0.0)">http://www.tta.or.kr/data/ttasDown.jsp?where=14688&amp;pk_num=TTAT.3G-36.414(R11-11.0.0)</a>	
TTC	TS-3GA-36.414(Rel11)v11.0.0	11.0.0	Jun 13	<a href="http://www.ttc.or.jp/jp/document_list/free/3gpps2013/TS/TS-3GA-36.414(Rel11)v11.0.0.pdf">http://www.ttc.or.jp/jp/document_list/free/3gpps2013/TS/TS-3GA-36.414(Rel11)v11.0.0.pdf</a>	

**Release 12**

ARIB	Not applicable			
ATIS	ATIS.3GPP.36.414V1210-2015	12.1.0	May 15	<a href="https://www.atis.org/docstore/default.aspx">https://www.atis.org/docstore/default.aspx</a>
CCSA	CCSA-TSD-LTE-36.414	12.1.0	Apr 15	<a href="http://www.ccsa.org.cn/ITU_spec/ITU-R/M.2012/M.2012-2/LTE/Rel-12/CCSA-TSD-LTE-36414-c10.zip">http://www.ccsa.org.cn/ITU_spec/ITU-R/M.2012/M.2012-2/LTE/Rel-12/CCSA-TSD-LTE-36414-c10.zip</a>
ETSI	ETSI TS 136 414	12.1.0	Feb 15	<a href="http://www.etsi.org/deliver/etsi_ts/136400_136499/136414/12.01.00_60/ts_136414v120100p.pdf">http://www.etsi.org/deliver/etsi_ts/136400_136499/136414/12.01.00_60/ts_136414v120100p.pdf</a>
TTA	TTAT.3G-36.414(R12-12.1.0)	12.1.0	Apr 15	<a href="http://www.tta.or.kr/data/ttasDown.jsp?where=14688&amp;pk_num=TTAT.3G-36.414(R12-12.1.0)">http://www.tta.or.kr/data/ttasDown.jsp?where=14688&amp;pk_num=TTAT.3G-36.414(R12-12.1.0)</a>
TTC	TS-3GA-36.414(Rel12)v12.1.0	12.1.0	Mar 15	<a href="http://www.ttc.or.jp/jp/document_list/free/3gpps2015/TS/TS-3GA-36.414(Rel12)v12.1.0.pdf">http://www.ttc.or.jp/jp/document_list/free/3gpps2015/TS/TS-3GA-36.414(Rel12)v12.1.0.pdf</a>

**1.2.1.4.7 TS 36.420****Evolved Universal Terrestrial Radio Access Network (E-UTRAN); X2 general aspects and principles**

This document is an introduction to the TSG RAN TS 36.42x series of UMTS technical specifications that define the X2 interface. It is an interface for the interconnection of two E-UTRAN NodeB (eNodeB) components within the Evolved Universal Terrestrial Radio Access Network (E-UTRAN) architecture.

SDO (2)	Document No.	Version	Issued date	Location (1)
<b>Release 10</b>				
ARIB	Not applicable			
ATIS	ATIS.3GPP.36.420V1020-2013	10.2.0	Jun 13	<a href="https://www.atis.org/docstore/default.aspx">https://www.atis.org/docstore/default.aspx</a>
CCSA	CCSA-TSD-LTE-36.420	10.2.0	Apr 15	<a href="http://www.ccsa.org.cn/ITU_spec/ITU-R/M.2012/M.2012-2/LTE/Rel-10/CCSA-TSD-LTE-36420-a20.zip">http://www.ccsa.org.cn/ITU_spec/ITU-R/M.2012/M.2012-2/LTE/Rel-10/CCSA-TSD-LTE-36420-a20.zip</a>
ETSI	ETSI TS 136 420	10.2.0	Oct 11	<a href="http://www.etsi.org/deliver/etsi_ts/136400_136499/136420/10.02.00_60/ts_136420v100200p.pdf">http://www.etsi.org/deliver/etsi_ts/136400_136499/136420/10.02.00_60/ts_136420v100200p.pdf</a>
TTC	TS-3GA-36.420(Rel10)v10.2.0	10.2.0	Dec 11	<a href="http://www.ttc.or.jp/jp/document_list/free/3gpps2011/TS/TS-3GA-36.420(Rel10)v10.2.0.pdf">http://www.ttc.or.jp/jp/document_list/free/3gpps2011/TS/TS-3GA-36.420(Rel10)v10.2.0.pdf</a>
<b>Release 11</b>				
ARIB	Not applicable			
ATIS	ATIS.3GPP.36.420V1100-2013	11.0.0	Jun 13	<a href="https://www.atis.org/docstore/default.aspx">https://www.atis.org/docstore/default.aspx</a>
CCSA	CCSA-TSD-LTE-36.420	11.0.0	Apr 15	<a href="http://www.ccsa.org.cn/ITU_spec/ITU-R/M.2012/M.2012-2/LTE/Rel-11/CCSA-TSD-LTE-36420-b00.zip">http://www.ccsa.org.cn/ITU_spec/ITU-R/M.2012/M.2012-2/LTE/Rel-11/CCSA-TSD-LTE-36420-b00.zip</a>
ETSI	ETSI TS 136 420	11.0.0	Oct 12	<a href="http://www.etsi.org/deliver/etsi_ts/136400_136499/136420/11.00.00_60/ts_136420v110000p.pdf">http://www.etsi.org/deliver/etsi_ts/136400_136499/136420/11.00.00_60/ts_136420v110000p.pdf</a>
TTA	TTAT.3G-36.420(R11-11.0.0)	11.0.0	Aug 13	<a href="http://www.tta.or.kr/data/ttasDown.jsp?where=14688&amp;pk_num=TTAT.3G-36.420(R11-11.0.0)">http://www.tta.or.kr/data/ttasDown.jsp?where=14688&amp;pk_num=TTAT.3G-36.420(R11-11.0.0)</a>
TTC	TS-3GA-36.420(Rel11)v11.0.0	11.0.0	Jun 13	<a href="http://www.ttc.or.jp/jp/document_list/free/3gpps2013/TS/TS-3GA-36.420(Rel11)v11.0.0.pdf">http://www.ttc.or.jp/jp/document_list/free/3gpps2013/TS/TS-3GA-36.420(Rel11)v11.0.0.pdf</a>
<b>Release 12</b>				
ARIB	Not applicable			
ATIS	ATIS.3GPP.36.420V1210-2015	12.1.0	May 15	<a href="https://www.atis.org/docstore/default.aspx">https://www.atis.org/docstore/default.aspx</a>
CCSA	CCSA-TSD-LTE-36.420	12.1.0	Apr 15	<a href="http://www.ccsa.org.cn/ITU_spec/ITU-R/M.2012/M.2012-2/LTE/Rel-12/CCSA-TSD-LTE-36420-c10.zip">http://www.ccsa.org.cn/ITU_spec/ITU-R/M.2012/M.2012-2/LTE/Rel-12/CCSA-TSD-LTE-36420-c10.zip</a>
ETSI	ETSI TS 136 420	12.1.0	Feb 15	<a href="http://www.etsi.org/deliver/etsi_ts/136400_136499/136420/12.01.00_60/ts_136420v120100p.pdf">http://www.etsi.org/deliver/etsi_ts/136400_136499/136420/12.01.00_60/ts_136420v120100p.pdf</a>
TTA	TTAT.3G-36.420(R12-12.1.0)	12.1.0	Apr 15	<a href="http://www.tta.or.kr/data/ttasDown.jsp?where=14688&amp;pk_num=TTAT.3G-36.420(R12-12.1.0)">http://www.tta.or.kr/data/ttasDown.jsp?where=14688&amp;pk_num=TTAT.3G-36.420(R12-12.1.0)</a>
TTC	TS-3GA-36.420(Rel12)v12.1.0	12.1.0	Mar 15	<a href="http://www.ttc.or.jp/jp/document_list/free/3gpps2015/TS/TS-3GA-36.420(Rel12)v12.1.0.pdf">http://www.ttc.or.jp/jp/document_list/free/3gpps2015/TS/TS-3GA-36.420(Rel12)v12.1.0.pdf</a>

### 1.2.1.4.8 TS 36.421

#### Evolved Universal Terrestrial Radio Access Network (E-UTRAN); X2 layer 1

This document specifies the standards allowed to implement Layer 1 on the X2 interface. The specification of transmission delay requirements and O & M requirements are not in the scope of this document. In the following “Layer 1” and “Physical Layer” are assumed to be synonymous.

SDO (2)	Document No.	Version	Issued date		Location (1)
<b>Release 10</b>					
ARIB	Not applicable				
ATIS	ATIS.3GPP.36.421V1001-2011		10.0.1	Jul 11	<a href="https://www.atis.org/docstore/default.aspx">https://www.atis.org/docstore/default.aspx</a>
CCSA	CCSA-TSD-LTE-36.421		10.0.1	Apr 15	<a href="http://www.ccsa.org.cn/ITU_spec/ITU-R/M.2012/M.2012-2/LTE/Rel-10/CCSA-TSD-LTE-36421-a01.zip">http://www.ccsa.org.cn/ITU_spec/ITU-R/M.2012/M.2012-2/LTE/Rel-10/CCSA-TSD-LTE-36421-a01.zip</a>
ETSI	ETSI TS 136 421		10.0.1	May 11	<a href="http://www.etsi.org/deliver/etsi_ts/136400_136499/136421/10.00.01_60/ts_136421v100001p.pdf">http://www.etsi.org/deliver/etsi_ts/136400_136499/136421/10.00.01_60/ts_136421v100001p.pdf</a>
TTC	TS-3GA-36.421(Rel10)v10.0.1		10.0.1	Jun 11	<a href="http://www.ttc.or.jp/jp/document_list/free/3gpps2011/TS/TS-3GA-36.421(Rel10)v10.0.1.pdf">http://www.ttc.or.jp/jp/document_list/free/3gpps2011/TS/TS-3GA-36.421(Rel10)v10.0.1.pdf</a>
<b>Release 11</b>					
ARIB	Not applicable				
ATIS	ATIS.3GPP.36.421V1110-2013		11.1.0	Jun 13	<a href="https://www.atis.org/docstore/default.aspx">https://www.atis.org/docstore/default.aspx</a>
CCSA	CCSA-TSD-LTE-36.421		11.1.0	Apr 15	<a href="http://www.ccsa.org.cn/ITU_spec/ITU-R/M.2012/M.2012-2/LTE/Rel-11/CCSA-TSD-LTE-36421-b10.zip">http://www.ccsa.org.cn/ITU_spec/ITU-R/M.2012/M.2012-2/LTE/Rel-11/CCSA-TSD-LTE-36421-b10.zip</a>
ETSI	ETSI TS 136 421		11.1.0	Jan 13	<a href="http://www.etsi.org/deliver/etsi_ts/136400_136499/136421/11.01.00_60/ts_136421v110100p.pdf">http://www.etsi.org/deliver/etsi_ts/136400_136499/136421/11.01.00_60/ts_136421v110100p.pdf</a>
TTA	TTAT.3G-36.421(R11-11.1.0)		11.1.0	Aug 13	<a href="http://www.tta.or.kr/data/ttasDown.jsp?where=14688&amp;pk_num=TTAT.3G-36.421(R11-11.1.0)">http://www.tta.or.kr/data/ttasDown.jsp?where=14688&amp;pk_num=TTAT.3G-36.421(R11-11.1.0)</a>
TTC	TS-3GA-36.421(Rel11)v11.1.0		11.1.0	Jun 13	<a href="http://www.ttc.or.jp/jp/document_list/free/3gpps2013/TS/TS-3GA-36.421(Rel11)v11.1.0.pdf">http://www.ttc.or.jp/jp/document_list/free/3gpps2013/TS/TS-3GA-36.421(Rel11)v11.1.0.pdf</a>
<b>Release 12</b>					
ARIB	Not applicable				
ATIS	ATIS.3GPP.36.421V1200-2015		12.0.0	May 15	<a href="https://www.atis.org/docstore/default.aspx">https://www.atis.org/docstore/default.aspx</a>
CCSA	CCSA-TSD-LTE-36.421		12.0.0	Apr 15	<a href="http://www.ccsa.org.cn/ITU_spec/ITU-R/M.2012/M.2012-2/LTE/Rel-12/CCSA-TSD-LTE-36421-c00.zip">http://www.ccsa.org.cn/ITU_spec/ITU-R/M.2012/M.2012-2/LTE/Rel-12/CCSA-TSD-LTE-36421-c00.zip</a>
ETSI	ETSI TS 136 421		12.0.0	Sep 14	<a href="http://www.etsi.org/deliver/etsi_ts/136400_136499/136421/12.00.00_60/ts_136421v120000p.pdf">http://www.etsi.org/deliver/etsi_ts/136400_136499/136421/12.00.00_60/ts_136421v120000p.pdf</a>
TTA	TTAT.3G-36.421(R12-12.0.0)		12.0.0	Apr 15	<a href="http://www.tta.or.kr/data/ttasDown.jsp?where=14688&amp;pk_num=TTAT.3G-36.421(R12-12.0.0)">http://www.tta.or.kr/data/ttasDown.jsp?where=14688&amp;pk_num=TTAT.3G-36.421(R12-12.0.0)</a>
TTC	TS-3GA-36.421(Rel12)v12.0.0		12.0.0	Mar 15	<a href="http://www.ttc.or.jp/jp/document_list/free/3gpps2015/TS/TS-3GA-36.421(Rel12)v12.0.0.pdf">http://www.ttc.or.jp/jp/document_list/free/3gpps2015/TS/TS-3GA-36.421(Rel12)v12.0.0.pdf</a>

### 1.2.1.4.9 TS 36.422

#### Evolved Universal Terrestrial Radio Access Network (E-UTRAN); X2 signalling transport

This document specifies the standards for Signalling Transport to be used across X2 interface. X2 interface is a logical interface between eNodeBs. This document describes how the X2-AP signalling messages are transported over X2.

SDO (2)	Document No.	Version	Issued date		Location (1)
<b>Release 10</b>					
ARIB	Not applicable				
ATIS	ATIS.3GPP.36.422V1010-2011		10.1.0	Jul 11	<a href="https://www.atis.org/docstore/default.aspx">https://www.atis.org/docstore/default.aspx</a>
CCSA	CCSA-TSD-LTE-36.422		10.1.0	Apr 15	<a href="http://www.ccsa.org.cn/ITU_spec/ITU-R/M.2012/M.2012-2/LTE/Rel-10/CCSA-TSD-LTE-36422-a10.zip">http://www.ccsa.org.cn/ITU_spec/ITU-R/M.2012/M.2012-2/LTE/Rel-10/CCSA-TSD-LTE-36422-a10.zip</a>
ETSI	ETSI TS 136 422		10.1.0	Jun 11	<a href="http://www.etsi.org/deliver/etsi_ts/136400_136499/136422/10.01.00_60/ts_136422v100100p.pdf">http://www.etsi.org/deliver/etsi_ts/136400_136499/136422/10.01.00_60/ts_136422v100100p.pdf</a>
TTC	TS-3GA-36.422(Rel10)v10.1.0		10.1.0	Jun 11	<a href="http://www.ttc.or.jp/jp/document_list/free/3gpps2011/TS/TS-3GA-36.422(Rel10)v10.1.0.pdf">http://www.ttc.or.jp/jp/document_list/free/3gpps2011/TS/TS-3GA-36.422(Rel10)v10.1.0.pdf</a>
<b>Release 11</b>					



ARIB	Not applicable				
ATIS	ATIS.3GPP.36.422V1100-2013	11.0.0	Jun 13	<a href="https://www.atis.org/docstore/default.aspx">https://www.atis.org/docstore/default.aspx</a>	
CCSA	CCSA-TSD-LTE-36.422	11.0.0	Apr 15	<a href="http://www.ccsa.org.cn/ITU_spec/ITU-R/M.2012/M.2012-2/LTE/Rel-11/CCSA-TSD-LTE-36422-b00.zip">http://www.ccsa.org.cn/ITU_spec/ITU-R/M.2012/M.2012-2/LTE/Rel-11/CCSA-TSD-LTE-36422-b00.zip</a>	
ETSI	ETSI TS 136 422	11.0.0	Oct 12	<a href="http://www.etsi.org/deliver/etsi_ts/136400_136499/136422/11.00.00_60/ts_136422v110000p.pdf">http://www.etsi.org/deliver/etsi_ts/136400_136499/136422/11.00.00_60/ts_136422v110000p.pdf</a>	
TTA	TTAT.3G-36.422(R11-11.0.0)	11.0.0	Aug 13	<a href="http://www.tta.or.kr/data/ttasDown.jsp?where=14688&amp;pk_num=TTAT.3G-36.422(R11-11.0.0)">http://www.tta.or.kr/data/ttasDown.jsp?where=14688&amp;pk_num=TTAT.3G-36.422(R11-11.0.0)</a>	
TTC	TS-3GA-36.422(Rel11)v11.0.0	11.0.0	Jun 13	<a href="http://www.ttc.or.jp/jp/document_list/free/3gpps2013/TS/TS-3GA-36.422(Rel11)v11.0.0.pdf">http://www.ttc.or.jp/jp/document_list/free/3gpps2013/TS/TS-3GA-36.422(Rel11)v11.0.0.pdf</a>	
<b>Release 12</b>					
ARIB	Not applicable				
ATIS	ATIS.3GPP.36.422V1200-2015	12.0.0	May 15	<a href="https://www.atis.org/docstore/default.aspx">https://www.atis.org/docstore/default.aspx</a>	
CCSA	CCSA-TSD-LTE-36.422	12.0.0	Apr 15	<a href="http://www.ccsa.org.cn/ITU_spec/ITU-R/M.2012/M.2012-2/LTE/Rel-12/CCSA-TSD-LTE-36422-c00.zip">http://www.ccsa.org.cn/ITU_spec/ITU-R/M.2012/M.2012-2/LTE/Rel-12/CCSA-TSD-LTE-36422-c00.zip</a>	
ETSI	ETSI TS 136 422	12.0.0	Sep 14	<a href="http://www.etsi.org/deliver/etsi_ts/136400_136499/136422/12.00.00_60/ts_136422v120000p.pdf">http://www.etsi.org/deliver/etsi_ts/136400_136499/136422/12.00.00_60/ts_136422v120000p.pdf</a>	
TTA	TTAT.3G-36.422(R12-12.0.0)	12.0.0	Apr 15	<a href="http://www.tta.or.kr/data/ttasDown.jsp?where=14688&amp;pk_num=TTAT.3G-36.422(R12-12.0.0)">http://www.tta.or.kr/data/ttasDown.jsp?where=14688&amp;pk_num=TTAT.3G-36.422(R12-12.0.0)</a>	
TTC	TS-3GA-36.422(Rel12)v12.0.0	12.0.0	Mar 15	<a href="http://www.ttc.or.jp/jp/document_list/free/3gpps2015/TS/TS-3GA-36.422(Rel12)v12.0.0.pdf">http://www.ttc.or.jp/jp/document_list/free/3gpps2015/TS/TS-3GA-36.422(Rel12)v12.0.0.pdf</a>	

### 1.2.1.4.10 TS 36.423

#### Evolved Universal Terrestrial Radio Access Network (E-UTRAN); X2 Application Protocol (X2AP)

This document specifies the radio network layer signalling procedures of the control plane between eNodeBs in E-UTRAN. X2AP supports the functions of X2 interface by signalling procedures defined in this document.

SDO (2)	Document No.	Version	Issued date	Location (1)
<b>Release 10</b>				
ARIB	Not applicable			
ATIS	ATIS.3GPP.36.423V1070-2015	10.7.0	May 15	<a href="https://www.atis.org/docstore/default.aspx">https://www.atis.org/docstore/default.aspx</a>
CCSA	CCSA-TSD-LTE-36.423	10.7.0	Apr 15	<a href="http://www.ccsa.org.cn/ITU_spec/ITU-R/M.2012/M.2012-2/LTE/Rel-10/CCSA-TSD-LTE-36423-a70.zip">http://www.ccsa.org.cn/ITU_spec/ITU-R/M.2012/M.2012-2/LTE/Rel-10/CCSA-TSD-LTE-36423-a70.zip</a>
ETSI	ETSI TS 136 423	10.7.0	Sep 13	<a href="http://www.etsi.org/deliver/etsi_ts/136400_136499/136423/10.07.00_60/ts_136423v100700p.pdf">http://www.etsi.org/deliver/etsi_ts/136400_136499/136423/10.07.00_60/ts_136423v100700p.pdf</a>
TTC	TS-3GA-36.423(Rel10)v10.7.0	10.7.0	Dec 13	<a href="http://www.ttc.or.jp/jp/document_list/free/3gpps2013/TS/TS-3GA-36.423(Rel10)v10.7.0.pdf">http://www.ttc.or.jp/jp/document_list/free/3gpps2013/TS/TS-3GA-36.423(Rel10)v10.7.0.pdf</a>
<b>Release 11</b>				
ARIB	Not applicable			
ATIS	ATIS.3GPP.36.423V1180-2015	11.8.0	May 15	<a href="https://www.atis.org/docstore/default.aspx">https://www.atis.org/docstore/default.aspx</a>
CCSA	CCSA-TSD-LTE-36.423	11.8.0	Apr 15	<a href="http://www.ccsa.org.cn/ITU_spec/ITU-R/M.2012/M.2012-2/LTE/Rel-11/CCSA-TSD-LTE-36423-b80.zip">http://www.ccsa.org.cn/ITU_spec/ITU-R/M.2012/M.2012-2/LTE/Rel-11/CCSA-TSD-LTE-36423-b80.zip</a>
ETSI	ETSI TS 136 423	11.8.0	Mar 14	<a href="http://www.etsi.org/deliver/etsi_ts/136400_136499/136423/11.08.00_60/ts_136423v110800p.pdf">http://www.etsi.org/deliver/etsi_ts/136400_136499/136423/11.08.00_60/ts_136423v110800p.pdf</a>
TTA	TTAT.3G-36.423(R11-11.4.0)	11.4.0	Aug 13	<a href="http://www.tta.or.kr/data/ttasDown.jsp?where=14688&amp;pk_num=TTAT.3G-36.423(R11-11.4.0)">http://www.tta.or.kr/data/ttasDown.jsp?where=14688&amp;pk_num=TTAT.3G-36.423(R11-11.4.0)</a>
TTC	TS-3GA-36.423(Rel11)v11.8.0	11.8.0	Jun 14	<a href="http://www.ttc.or.jp/jp/document_list/free/3gpps2014/TS/TS-3GA-36.423(Rel11)v11.8.0.pdf">http://www.ttc.or.jp/jp/document_list/free/3gpps2014/TS/TS-3GA-36.423(Rel11)v11.8.0.pdf</a>
<b>Release 12</b>				
ARIB	Not applicable			
ATIS	ATIS.3GPP.36.423V1242-2015	12.4.2	May 15	<a href="https://www.atis.org/docstore/default.aspx">https://www.atis.org/docstore/default.aspx</a>
CCSA	CCSA-TSD-LTE-36.423	12.4.2	Apr 15	<a href="http://www.ccsa.org.cn/ITU_spec/ITU-R/M.2012/M.2012-2/LTE/Rel-12/CCSA-TSD-LTE-36423-c42.zip">http://www.ccsa.org.cn/ITU_spec/ITU-R/M.2012/M.2012-2/LTE/Rel-12/CCSA-TSD-LTE-36423-c42.zip</a>
ETSI	ETSI TS 136 423	12.4.2	Feb 15	<a href="http://www.etsi.org/deliver/etsi_ts/136400_136499/136423/12.04.02_60/ts_136423v120402p.pdf">http://www.etsi.org/deliver/etsi_ts/136400_136499/136423/12.04.02_60/ts_136423v120402p.pdf</a>
TTA	TTAT.3G-36.423(R12-12.4.2)	12.4.2	Apr 15	<a href="http://www.tta.or.kr/data/ttasDown.jsp?where=14688&amp;pk_num=TTAT.3G-36.423(R12-12.4.2)">http://www.tta.or.kr/data/ttasDown.jsp?where=14688&amp;pk_num=TTAT.3G-36.423(R12-12.4.2)</a>
TTC	TS-3GA-36.423(Rel12)v12.4.2	12.4.2	Mar 15	<a href="http://www.ttc.or.jp/jp/document_list/free/3gpps2015/TS/TS-3GA-36.423(Rel12)v12.4.2.pdf">http://www.ttc.or.jp/jp/document_list/free/3gpps2015/TS/TS-3GA-36.423(Rel12)v12.4.2.pdf</a>

## 1.2.1.4.11 TS 36.424

**Evolved Universal Terrestrial Radio Access Network (E-UTRAN); X2 data transport**

This document specifies the standards for user data transport protocols and related signalling protocols to establish user plane transport bearers over the X2 interface.

SDO (2)	Document No.	Version	Issued date	Location (1)
<b>Release 10</b>				
ARIB	Not applicable			
ATIS	ATIS.3GPP.36.424V1010-2011		10.1.0 Jul 11	<a href="https://www.atis.org/docstore/default.aspx">https://www.atis.org/docstore/default.aspx</a>
CCSA	CCSA-TSD-LTE-36.424		10.1.0 Apr 15	<a href="http://www.ccsa.org.cn/ITU_spec/ITU-R/M.2012/M.2012-2/LTE/Rel-10/CCSA-TSD-LTE-36424-a10.zip">http://www.ccsa.org.cn/ITU_spec/ITU-R/M.2012/M.2012-2/LTE/Rel-10/CCSA-TSD-LTE-36424-a10.zip</a>
ETSI	ETSI TS 136 424		10.1.0 Jun 11	<a href="http://www.etsi.org/deliver/etsi_ts/136400_136499/136424/10.01.00_60/ts_136424v100100p.pdf">http://www.etsi.org/deliver/etsi_ts/136400_136499/136424/10.01.00_60/ts_136424v100100p.pdf</a>
TTC	TS-3GA-36.424(Rel10)v10.1.0		10.1.0 Jun 11	<a href="http://www.ttc.or.jp/jp/document_list/free/3gpps2011/TS/TS-3GA-36.424(Rel10)v10.1.0.pdf">http://www.ttc.or.jp/jp/document_list/free/3gpps2011/TS/TS-3GA-36.424(Rel10)v10.1.0.pdf</a>
<b>Release 11</b>				
ARIB	Not applicable			
ATIS	ATIS.3GPP.36.424V1100-2013		11.0.0 Jun 13	<a href="https://www.atis.org/docstore/default.aspx">https://www.atis.org/docstore/default.aspx</a>
CCSA	CCSA-TSD-LTE-36.424		11.0.0 Apr 15	<a href="http://www.ccsa.org.cn/ITU_spec/ITU-R/M.2012/M.2012-2/LTE/Rel-11/CCSA-TSD-LTE-36424-b00.zip">http://www.ccsa.org.cn/ITU_spec/ITU-R/M.2012/M.2012-2/LTE/Rel-11/CCSA-TSD-LTE-36424-b00.zip</a>
ETSI	ETSI TS 136 424		11.0.0 Oct 12	<a href="http://www.etsi.org/deliver/etsi_ts/136400_136499/136424/11.00.00_60/ts_136424v110000p.pdf">http://www.etsi.org/deliver/etsi_ts/136400_136499/136424/11.00.00_60/ts_136424v110000p.pdf</a>
TTA	TTAT.3G-36.424(R11-11.0.0)		11.0.0 Aug 13	<a href="http://www.tta.or.kr/data/ttasDown.jsp?where=14688&amp;pk_num=TTAT.3G-36.424(R11-11.0.0)">http://www.tta.or.kr/data/ttasDown.jsp?where=14688&amp;pk_num=TTAT.3G-36.424(R11-11.0.0)</a>
TTC	TS-3GA-36.424(Rel11)v11.0.0		11.0.0 Jun 13	<a href="http://www.ttc.or.jp/jp/document_list/free/3gpps2013/TS/TS-3GA-36.424(Rel11)v11.0.0.pdf">http://www.ttc.or.jp/jp/document_list/free/3gpps2013/TS/TS-3GA-36.424(Rel11)v11.0.0.pdf</a>
<b>Release 12</b>				
ARIB	Not applicable			
ATIS	ATIS.3GPP.36.424V1210-2015		12.1.0 May 15	<a href="https://www.atis.org/docstore/default.aspx">https://www.atis.org/docstore/default.aspx</a>
CCSA	CCSA-TSD-LTE-36.424		12.1.0 Apr 15	<a href="http://www.ccsa.org.cn/ITU_spec/ITU-R/M.2012/M.2012-2/LTE/Rel-12/CCSA-TSD-LTE-36424-c10.zip">http://www.ccsa.org.cn/ITU_spec/ITU-R/M.2012/M.2012-2/LTE/Rel-12/CCSA-TSD-LTE-36424-c10.zip</a>
ETSI	ETSI TS 136 424		12.1.0 Feb 15	<a href="http://www.etsi.org/deliver/etsi_ts/136400_136499/136424/12.01.00_60/ts_136424v120100p.pdf">http://www.etsi.org/deliver/etsi_ts/136400_136499/136424/12.01.00_60/ts_136424v120100p.pdf</a>
TTA	TTAT.3G-36.424(R12-12.1.0)		12.1.0 Apr 15	<a href="http://www.tta.or.kr/data/ttasDown.jsp?where=14688&amp;pk_num=TTAT.3G-36.424(R12-12.1.0)">http://www.tta.or.kr/data/ttasDown.jsp?where=14688&amp;pk_num=TTAT.3G-36.424(R12-12.1.0)</a>
TTC	TS-3GA-36.424(Rel12)v12.1.0		12.1.0 Mar 15	<a href="http://www.ttc.or.jp/jp/document_list/free/3gpps2015/TS/TS-3GA-36.424(Rel12)v12.1.0.pdf">http://www.ttc.or.jp/jp/document_list/free/3gpps2015/TS/TS-3GA-36.424(Rel12)v12.1.0.pdf</a>

## 1.2.1.4.12 TS 36.425

**Evolved Universal Terrestrial Radio Access Network (E-UTRAN); X2 interface user plane protocol**

This document specifies the X2 user plane protocol being used over the X2 interface.

SDO (2)	Document No.	Version	Issued date	Location (1)
<b>Release 10 (not applicable – this specification added beginning with Release 12)</b>				
<b>Release 11 (not applicable – this specification added beginning with Release 12)</b>				
<b>Release 12</b>				
ARIB	Not applicable			
ATIS	ATIS.3GPP.36.425V1200-2015		12.0.0 May 15	<a href="https://www.atis.org/docstore/default.aspx">https://www.atis.org/docstore/default.aspx</a>
CCSA	CCSA-TSD-LTE-36.425		12.0.0 Apr 15	<a href="http://www.ccsa.org.cn/ITU_spec/ITU-R/M.2012/M.2012-2/LTE/Rel-12/CCSA-TSD-LTE-36425-c00.zip">http://www.ccsa.org.cn/ITU_spec/ITU-R/M.2012/M.2012-2/LTE/Rel-12/CCSA-TSD-LTE-36425-c00.zip</a>
ETSI	ETSI TS 136 425		12.0.0 Feb 15	<a href="http://www.etsi.org/deliver/etsi_ts/136400_136499/136425/12.00.00_60/ts_136425v120000p.pdf">http://www.etsi.org/deliver/etsi_ts/136400_136499/136425/12.00.00_60/ts_136425v120000p.pdf</a>
TTA	TTAT.3G-36.425(R12-12.0.0)		12.0.0 Apr 15	<a href="http://www.tta.or.kr/data/ttasDown.jsp?where=14688&amp;pk_num=TTAT.3G-36.425(R12-12.0.0)">http://www.tta.or.kr/data/ttasDown.jsp?where=14688&amp;pk_num=TTAT.3G-36.425(R12-12.0.0)</a>
TTC	TS-3GA-36.425(Rel12)v12.0.0		12.0.0 Mar 15	<a href="http://www.ttc.or.jp/jp/document_list/free/3gpps2015/TS/TS-3GA-36.425(Rel12)v12.0.0.pdf">http://www.ttc.or.jp/jp/document_list/free/3gpps2015/TS/TS-3GA-36.425(Rel12)v12.0.0.pdf</a>

**1.2.1.4.13 TS 36.440****Evolved Universal Terrestrial Radio Access Network (E-UTRAN); General aspects and principles for interfaces supporting Multimedia Broadcast Multicast Service (MBMS) within E-UTRAN**

This document describes the overall architecture of the interface for the provision of MBMS in the E-UTRAN. This includes also a description of the general aspects, assumptions and principles guiding the architecture and interface. The MBMS functions to be provided within that architecture are summarized. It provides an introduction to the TSG RAN TS 36.44x series of UMTS technical specifications that define the different interfaces introduced for MBMS provision in E-UTRAN.

SDO (2)	Document No.	Version	Issued date		Location (1)
<b>Release 10</b>					
ARIB	Not applicable				
ATIS	ATIS.3GPP.36.440V1030-2013		10.3.0	Jun 13	<a href="https://www.atis.org/docstore/default.aspx">https://www.atis.org/docstore/default.aspx</a>
CCSA	CCSA-TSD-LTE-36.440		10.3.0	Apr 15	<a href="http://www.ccsa.org.cn/ITU_spec/ITU-R/M.2012/M.2012-2/LTE/Rel-10/CCSA-TSD-LTE-36440-a30.zip">http://www.ccsa.org.cn/ITU_spec/ITU-R/M.2012/M.2012-2/LTE/Rel-10/CCSA-TSD-LTE-36440-a30.zip</a>
ETSI	ETSI TS 136 440		10.3.0	Jul 12	<a href="http://www.etsi.org/deliver/etsi_ts/136400_136499/136440/10.03.00_60/ts_136440v100300p.pdf">http://www.etsi.org/deliver/etsi_ts/136400_136499/136440/10.03.00_60/ts_136440v100300p.pdf</a>
TTC	TS-3GA-36.440(Rel10)v10.3.0		10.3.0	Sep 12	<a href="http://www.ttc.or.jp/jp/document_list/free/3gpps2012/TS/TS-3GA-36.440(Rel10)v10.3.0.pdf">http://www.ttc.or.jp/jp/document_list/free/3gpps2012/TS/TS-3GA-36.440(Rel10)v10.3.0.pdf</a>
<b>Release 11</b>					
ARIB	Not applicable				
ATIS	ATIS.3GPP.36.440V1120-2013		11.2.0	Jun 13	<a href="https://www.atis.org/docstore/default.aspx">https://www.atis.org/docstore/default.aspx</a>
CCSA	CCSA-TSD-LTE-36.440		11.2.0	Apr 15	<a href="http://www.ccsa.org.cn/ITU_spec/ITU-R/M.2012/M.2012-2/LTE/Rel-11/CCSA-TSD-LTE-36440-b20.zip">http://www.ccsa.org.cn/ITU_spec/ITU-R/M.2012/M.2012-2/LTE/Rel-11/CCSA-TSD-LTE-36440-b20.zip</a>
ETSI	ETSI TS 136 440		11.2.0	Apr 13	<a href="http://www.etsi.org/deliver/etsi_ts/136400_136499/136440/11.02.00_60/ts_136440v110200p.pdf">http://www.etsi.org/deliver/etsi_ts/136400_136499/136440/11.02.00_60/ts_136440v110200p.pdf</a>
TTA	TTAT.3G-36.440(R11-11.2.0)		11.2.0	Aug 13	<a href="http://www.tta.or.kr/data/ttasDown.jsp?where=14688&amp;pk_num=TTAT.3G-36.440(R11-11.2.0)">http://www.tta.or.kr/data/ttasDown.jsp?where=14688&amp;pk_num=TTAT.3G-36.440(R11-11.2.0)</a>
TTC	TS-3GA-36.440(Rel11)v11.2.0		11.2.0	Jun 13	<a href="http://www.ttc.or.jp/jp/document_list/free/3gpps2013/TS/TS-3GA-36.440(Rel11)v11.2.0.pdf">http://www.ttc.or.jp/jp/document_list/free/3gpps2013/TS/TS-3GA-36.440(Rel11)v11.2.0.pdf</a>
<b>Release 12</b>					
ARIB	Not applicable				
ATIS	ATIS.3GPP.36.440V1200-2015		12.0.0	May 15	<a href="https://www.atis.org/docstore/default.aspx">https://www.atis.org/docstore/default.aspx</a>
CCSA	CCSA-TSD-LTE-36.440		12.0.0	Apr 15	<a href="http://www.ccsa.org.cn/ITU_spec/ITU-R/M.2012/M.2012-2/LTE/Rel-12/CCSA-TSD-LTE-36440-c00.zip">http://www.ccsa.org.cn/ITU_spec/ITU-R/M.2012/M.2012-2/LTE/Rel-12/CCSA-TSD-LTE-36440-c00.zip</a>
ETSI	ETSI TS 136 440		12.0.0	Sep 14	<a href="http://www.etsi.org/deliver/etsi_ts/136400_136499/136440/12.00.00_60/ts_136440v120000p.pdf">http://www.etsi.org/deliver/etsi_ts/136400_136499/136440/12.00.00_60/ts_136440v120000p.pdf</a>
TTA	TTAT.3G-36.440(R12-12.0.0)		12.0.0	Apr 15	<a href="http://www.tta.or.kr/data/ttasDown.jsp?where=14688&amp;pk_num=TTAT.3G-36.440(R12-12.0.0)">http://www.tta.or.kr/data/ttasDown.jsp?where=14688&amp;pk_num=TTAT.3G-36.440(R12-12.0.0)</a>
TTC	TS-3GA-36.440(Rel12)v12.0.0		12.0.0	Mar 15	<a href="http://www.ttc.or.jp/jp/document_list/free/3gpps2015/TS/TS-3GA-36.440(Rel12)v12.0.0.pdf">http://www.ttc.or.jp/jp/document_list/free/3gpps2015/TS/TS-3GA-36.440(Rel12)v12.0.0.pdf</a>

**1.2.1.4.14 TS 36.441****Evolved Universal Terrestrial Radio Access Network (E-UTRAN); Layer 1 for interfaces supporting Multimedia Broadcast Multicast Service (MBMS) within E-UTRAN**

This document specifies the standards allowed to implement layer 1 on the interfaces supporting Multimedia Broadcast Multicast Service (MBMS) within E-UTRAN. In the following, “layer 1” and “physical layer” are assumed to be synonymous.

SDO (2)	Document No.	Version	Issued date		Location (1)
<b>Release 10</b>					
ARIB	Not applicable				
ATIS	ATIS.3GPP.36.441V1010-2011		10.1.0	Jul 11	<a href="https://www.atis.org/docstore/default.aspx">https://www.atis.org/docstore/default.aspx</a>
CCSA	CCSA-TSD-LTE-36.441		10.1.0	Apr 15	<a href="http://www.ccsa.org.cn/ITU_spec/ITU-R/M.2012/M.2012-2/LTE/Rel-10/CCSA-TSD-LTE-36441-a10.zip">http://www.ccsa.org.cn/ITU_spec/ITU-R/M.2012/M.2012-2/LTE/Rel-10/CCSA-TSD-LTE-36441-a10.zip</a>
ETSI	ETSI TS 136 441		10.1.0	Jun 11	<a href="http://www.etsi.org/deliver/etsi_ts/136400_136499/136441/10.01.00_60/ts_136441v100100p.pdf">http://www.etsi.org/deliver/etsi_ts/136400_136499/136441/10.01.00_60/ts_136441v100100p.pdf</a>
TTC	TS-3GA-36.441(Rel10)v10.1.0		10.1.0	Jun 11	<a href="http://www.ttc.or.jp/jp/document_list/free/3gpps2011/TS/TS-3GA-36.441(Rel10)v10.1.0.pdf">http://www.ttc.or.jp/jp/document_list/free/3gpps2011/TS/TS-3GA-36.441(Rel10)v10.1.0.pdf</a>
<b>Release 11</b>					
ARIB	Not applicable				
ATIS	ATIS.3GPP.36.441V1100-2013		11.0.0	Jun 13	<a href="https://www.atis.org/docstore/default.aspx">https://www.atis.org/docstore/default.aspx</a>
CCSA	CCSA-TSD-LTE-36.441		11.0.0	Apr 15	<a href="http://www.ccsa.org.cn/ITU_spec/ITU-R/M.2012/M.2012-2/LTE/Rel-11/CCSA-TSD-LTE-36441-b00.zip">http://www.ccsa.org.cn/ITU_spec/ITU-R/M.2012/M.2012-2/LTE/Rel-11/CCSA-TSD-LTE-36441-b00.zip</a>
ETSI	ETSI TS 136 441		11.0.0	Oct 12	<a href="http://www.etsi.org/deliver/etsi_ts/136400_136499/136441/11.00.00_60/ts_136441v110000p.pdf">http://www.etsi.org/deliver/etsi_ts/136400_136499/136441/11.00.00_60/ts_136441v110000p.pdf</a>
TTA	TTAT.3G-36.441(R11-11.0.0)		11.0.0	Aug 13	<a href="http://www.tta.or.kr/data/ttasDown.jsp?where=14688&amp;pk_num=TTAT.3G-36.441(R11-11.0.0)">http://www.tta.or.kr/data/ttasDown.jsp?where=14688&amp;pk_num=TTAT.3G-36.441(R11-11.0.0)</a>
TTC	TS-3GA-36.441(Rel11)v11.0.0		11.0.0	Jun 13	<a href="http://www.ttc.or.jp/jp/document_list/free/3gpps2013/TS/TS-3GA-36.441(Rel11)v11.0.0.pdf">http://www.ttc.or.jp/jp/document_list/free/3gpps2013/TS/TS-3GA-36.441(Rel11)v11.0.0.pdf</a>
<b>Release 12</b>					
ARIB	Not applicable				
ATIS	ATIS.3GPP.36.441V1200-2015		12.0.0	May 15	<a href="https://www.atis.org/docstore/default.aspx">https://www.atis.org/docstore/default.aspx</a>
CCSA	CCSA-TSD-LTE-36.441		12.0.0	Apr 15	<a href="http://www.ccsa.org.cn/ITU_spec/ITU-R/M.2012/M.2012-2/LTE/Rel-12/CCSA-TSD-LTE-36441-c00.zip">http://www.ccsa.org.cn/ITU_spec/ITU-R/M.2012/M.2012-2/LTE/Rel-12/CCSA-TSD-LTE-36441-c00.zip</a>
ETSI	ETSI TS 136 441		12.0.0	Sep 14	<a href="http://www.etsi.org/deliver/etsi_ts/136400_136499/136441/12.00.00_60/ts_136441v120000p.pdf">http://www.etsi.org/deliver/etsi_ts/136400_136499/136441/12.00.00_60/ts_136441v120000p.pdf</a>
TTA	TTAT.3G-36.441(R12-12.0.0)		12.0.0	Apr 15	<a href="http://www.tta.or.kr/data/ttasDown.jsp?where=14688&amp;pk_num=TTAT.3G-36.441(R12-12.0.0)">http://www.tta.or.kr/data/ttasDown.jsp?where=14688&amp;pk_num=TTAT.3G-36.441(R12-12.0.0)</a>
TTC	TS-3GA-36.441(Rel12)v12.0.0		12.0.0	Mar 15	<a href="http://www.ttc.or.jp/jp/document_list/free/3gpps2015/TS/TS-3GA-36.441(Rel12)v12.0.0.pdf">http://www.ttc.or.jp/jp/document_list/free/3gpps2015/TS/TS-3GA-36.441(Rel12)v12.0.0.pdf</a>

### 1.2.1.4.15 TS 36.442

#### Evolved Universal Terrestrial Radio Access Network (E-UTRAN); Signalling Transport for interfaces supporting Multimedia Broadcast Multicast Service (MBMS) within E-UTRAN

This document specifies the standards for signalling transport to be used across M2 and M3 interfaces. M2 interface is a logical interface between the eNodeB and the MCE. M3 interface is a logical interface between the MCE and the MME. This document describes how the M2-AP signalling messages are transported over M2, and how the M3-AP signalling messages are transported over M3.

SDO (2)	Document No.	Version	Issued date		Location (1)
<b>Release 10</b>					
ARIB	Not applicable				
ATIS	ATIS.3GPP.36.442V1020-2013		10.2.0	Jun 13	<a href="https://www.atis.org/docstore/default.aspx">https://www.atis.org/docstore/default.aspx</a>
CCSA	CCSA-TSD-LTE-36.442		10.2.0	Apr 15	<a href="http://www.ccsa.org.cn/ITU_spec/ITU-R/M.2012/M.2012-2/LTE/Rel-10/CCSA-TSD-LTE-36442-a20.zip">http://www.ccsa.org.cn/ITU_spec/ITU-R/M.2012/M.2012-2/LTE/Rel-10/CCSA-TSD-LTE-36442-a20.zip</a>
ETSI	ETSI TS 136 442		10.2.0	Oct 11	<a href="http://www.etsi.org/deliver/etsi_ts/136400_136499/136442/10.02.00_60/ts_136442v100200p.pdf">http://www.etsi.org/deliver/etsi_ts/136400_136499/136442/10.02.00_60/ts_136442v100200p.pdf</a>
TTC	TS-3GA-36.442(Rel10)v10.2.0		10.2.0	Dec 11	<a href="http://www.ttc.or.jp/jp/document_list/free/3gpps2011/TS/TS-3GA-36.442(Rel10)v10.2.0.pdf">http://www.ttc.or.jp/jp/document_list/free/3gpps2011/TS/TS-3GA-36.442(Rel10)v10.2.0.pdf</a>
<b>Release 11</b>					
ARIB	Not applicable				
ATIS	ATIS.3GPP.36.442V1100-2013		11.0.0	Jun 13	<a href="https://www.atis.org/docstore/default.aspx">https://www.atis.org/docstore/default.aspx</a>
CCSA	CCSA-TSD-LTE-36.442		11.0.0	Apr 15	<a href="http://www.ccsa.org.cn/ITU_spec/ITU-R/M.2012/M.2012-2/LTE/Rel-11/CCSA-TSD-LTE-36442-b00.zip">http://www.ccsa.org.cn/ITU_spec/ITU-R/M.2012/M.2012-2/LTE/Rel-11/CCSA-TSD-LTE-36442-b00.zip</a>

ETSI	ETSI TS 136 442	11.0.0	Oct 12	<a href="http://www.etsi.org/deliver/etsi_ts/136400_136499/136442/11.00.00_60/ts_136442v110000p.pdf">http://www.etsi.org/deliver/etsi_ts/136400_136499/136442/11.00.00_60/ts_136442v110000p.pdf</a>
TTA	TTAT.3G-36.442(R11-11.0.0)	11.0.0	Aug 13	<a href="http://www.tta.or.kr/data/ttasDown.jsp?where=14688&amp;pk_num=TTAT.3G-36.442(R11-11.0.0)">http://www.tta.or.kr/data/ttasDown.jsp?where=14688&amp;pk_num=TTAT.3G-36.442(R11-11.0.0)</a>
TTC	TS-3GA-36.442(Rel11)v11.0.0	11.0.0	Jun 13	<a href="http://www.ttc.or.jp/jp/document_list/free/3gpps2013/TS/TS-3GA-36.442(Rel11)v11.0.0.pdf">http://www.ttc.or.jp/jp/document_list/free/3gpps2013/TS/TS-3GA-36.442(Rel11)v11.0.0.pdf</a>

**Release 12**

ARIB	Not applicable			
ATIS	ATIS.3GPP.36.442V1200-2015	12.0.0	May 15	<a href="https://www.atis.org/docstore/default.aspx">https://www.atis.org/docstore/default.aspx</a>
CCSA	CCSA-TSD-LTE-36.442	12.0.0	Apr 15	<a href="http://www.ccsa.org.cn/ITU_spec/ITU-R/M.2012/M.2012-2/LTE/Rel-12/CCSA-TSD-LTE-36442-c00.zip">http://www.ccsa.org.cn/ITU_spec/ITU-R/M.2012/M.2012-2/LTE/Rel-12/CCSA-TSD-LTE-36442-c00.zip</a>
ETSI	ETSI TS 136 442	12.0.0	Sep 14	<a href="http://www.etsi.org/deliver/etsi_ts/136400_136499/136442/12.00.00_60/ts_136442v120000p.pdf">http://www.etsi.org/deliver/etsi_ts/136400_136499/136442/12.00.00_60/ts_136442v120000p.pdf</a>
TTA	TTAT.3G-36.442(R12-12.0.0)	12.0.0	Apr 15	<a href="http://www.tta.or.kr/data/ttasDown.jsp?where=14688&amp;pk_num=TTAT.3G-36.442(R12-12.0.0)">http://www.tta.or.kr/data/ttasDown.jsp?where=14688&amp;pk_num=TTAT.3G-36.442(R12-12.0.0)</a>
TTC	TS-3GA-36.442(Rel12)v12.0.0	12.0.0	Mar 15	<a href="http://www.ttc.or.jp/jp/document_list/free/3gpps2015/TS/TS-3GA-36.442(Rel12)v12.0.0.pdf">http://www.ttc.or.jp/jp/document_list/free/3gpps2015/TS/TS-3GA-36.442(Rel12)v12.0.0.pdf</a>

**1.2.1.4.16 TS 36.443****Evolved Universal Terrestrial Radio Access Network (E-UTRAN); M2 Application Protocol (M2AP)**

This document specifies the E-UTRAN radio network layer signalling protocol for the M2 interface. The M2 Application Protocol (M2AP) supports the functions of M2 interface by signalling procedures defined in this document.

SDO (2)	Document No.	Version	Issued date	Location (1)
<b>Release 10</b>				
ARIB	Not applicable			
ATIS	ATIS.3GPP.36.443V1050-2013	10.5.0	Jun 13	<a href="https://www.atis.org/docstore/default.aspx">https://www.atis.org/docstore/default.aspx</a>
CCSA	CCSA-TSD-LTE-36.443	10.5.0	Apr 15	<a href="http://www.ccsa.org.cn/ITU_spec/ITU-R/M.2012/M.2012-2/LTE/Rel-10/CCSA-TSD-LTE-36443-a50.zip">http://www.ccsa.org.cn/ITU_spec/ITU-R/M.2012/M.2012-2/LTE/Rel-10/CCSA-TSD-LTE-36443-a50.zip</a>
ETSI	ETSI TS 136 443	10.5.0	Mar 12	<a href="http://www.etsi.org/deliver/etsi_ts/136400_136499/136443/10.05.00_60/ts_136443v100500p.pdf">http://www.etsi.org/deliver/etsi_ts/136400_136499/136443/10.05.00_60/ts_136443v100500p.pdf</a>
TTC	TS-3GA-36.443(Rel10)v10.5.0	10.5.0	Jun 12	<a href="http://www.ttc.or.jp/jp/document_list/free/3gpps2012/TS/TS-3GA-36.443(Rel10)v10.5.0.pdf">http://www.ttc.or.jp/jp/document_list/free/3gpps2012/TS/TS-3GA-36.443(Rel10)v10.5.0.pdf</a>
<b>Release 11</b>				
ARIB	Not applicable			
ATIS	ATIS.3GPP.36.443V1130-2015	11.3.0	May 15	<a href="https://www.atis.org/docstore/default.aspx">https://www.atis.org/docstore/default.aspx</a>
CCSA	CCSA-TSD-LTE-36.443	11.3.0	Apr 15	<a href="http://www.ccsa.org.cn/ITU_spec/ITU-R/M.2012/M.2012-2/LTE/Rel-11/CCSA-TSD-LTE-36443-b30.zip">http://www.ccsa.org.cn/ITU_spec/ITU-R/M.2012/M.2012-2/LTE/Rel-11/CCSA-TSD-LTE-36443-b30.zip</a>
ETSI	ETSI TS 136 443	11.3.0	Jul 13	<a href="http://www.etsi.org/deliver/etsi_ts/136400_136499/136443/11.03.00_60/ts_136443v110300p.pdf">http://www.etsi.org/deliver/etsi_ts/136400_136499/136443/11.03.00_60/ts_136443v110300p.pdf</a>
TTA	TTAT.3G-36.443(R11-11.2.0)	11.2.0	Aug 13	<a href="http://www.tta.or.kr/data/ttasDown.jsp?where=14688&amp;pk_num=TTAT.3G-36.443(R11-11.2.0)">http://www.tta.or.kr/data/ttasDown.jsp?where=14688&amp;pk_num=TTAT.3G-36.443(R11-11.2.0)</a>
TTC	TS-3GA-36.443(Rel11)v11.3.0	11.3.0	Aug 13	<a href="http://www.ttc.or.jp/jp/document_list/free/3gpps2013/TS/TS-3GA-36.443(Rel11)v11.3.0.pdf">http://www.ttc.or.jp/jp/document_list/free/3gpps2013/TS/TS-3GA-36.443(Rel11)v11.3.0.pdf</a>
<b>Release 12</b>				
ARIB	Not applicable			
ATIS	ATIS.3GPP.36.443V1210-2015	12.1.0	May 15	<a href="https://www.atis.org/docstore/default.aspx">https://www.atis.org/docstore/default.aspx</a>
CCSA	CCSA-TSD-LTE-36.443	12.1.0	Apr 15	<a href="http://www.ccsa.org.cn/ITU_spec/ITU-R/M.2012/M.2012-2/LTE/Rel-12/CCSA-TSD-LTE-36443-c10.zip">http://www.ccsa.org.cn/ITU_spec/ITU-R/M.2012/M.2012-2/LTE/Rel-12/CCSA-TSD-LTE-36443-c10.zip</a>
ETSI	ETSI TS 136 443	12.1.0	Feb 15	<a href="http://www.etsi.org/deliver/etsi_ts/136400_136499/136443/12.01.00_60/ts_136443v120100p.pdf">http://www.etsi.org/deliver/etsi_ts/136400_136499/136443/12.01.00_60/ts_136443v120100p.pdf</a>
TTA	TTAT.3G-36.443(R12-12.1.0)	12.1.0	Apr 15	<a href="http://www.tta.or.kr/data/ttasDown.jsp?where=14688&amp;pk_num=TTAT.3G-36.443(R12-12.1.0)">http://www.tta.or.kr/data/ttasDown.jsp?where=14688&amp;pk_num=TTAT.3G-36.443(R12-12.1.0)</a>
TTC	TS-3GA-36.443(Rel12)v12.1.0	12.1.0	Mar 15	<a href="http://www.ttc.or.jp/jp/document_list/free/3gpps2015/TS/TS-3GA-36.443(Rel12)v12.1.0.pdf">http://www.ttc.or.jp/jp/document_list/free/3gpps2015/TS/TS-3GA-36.443(Rel12)v12.1.0.pdf</a>

**1.2.1.4.17 TS 36.444****Evolved Universal Terrestrial Radio Access Network (E-UTRAN); M3 Application Protocol (M3AP)**

This document specifies the E-UTRAN radio network layer signalling protocol for the M3 interface. The M3 Application Protocol (M3AP) supports the functions of M3 interface by signalling procedures defined in this document.

SDO (2)	Document No.	Version	Issued date	Location (1)
<b>Release 10</b>				
ARIB	Not applicable			
ATIS	ATIS.3GPP.36.444V1040-2013		10.4.0 Jun 13	<a href="https://www.atis.org/docstore/default.aspx">https://www.atis.org/docstore/default.aspx</a>
CCSA	CCSA-TSD-LTE-36.444		10.4.0 Apr 15	<a href="http://www.ccsa.org.cn/ITU_spec/ITU-R/M.2012/M.2012-2/LTE/Rel-10/CCSA-TSD-LTE-36444-a40.zip">http://www.ccsa.org.cn/ITU_spec/ITU-R/M.2012/M.2012-2/LTE/Rel-10/CCSA-TSD-LTE-36444-a40.zip</a>
ETSI	ETSI TS 136 444		10.4.0 Jan 13	<a href="http://www.etsi.org/deliver/etsi_ts/136400_136499/136444/10.04.00_60/ts_136444v100400p.pdf">http://www.etsi.org/deliver/etsi_ts/136400_136499/136444/10.04.00_60/ts_136444v100400p.pdf</a>
TTC	TS-3GA-36.444(Rel10)v10.4.0		10.4.0 Jun 13	<a href="http://www.ttc.or.jp/jp/document_list/free/3gpps2013/TS/TS-3GA-36.444(Rel10)v10.4.0.pdf">http://www.ttc.or.jp/jp/document_list/free/3gpps2013/TS/TS-3GA-36.444(Rel10)v10.4.0.pdf</a>
<b>Release 11</b>				
ARIB	Not applicable			
ATIS	ATIS.3GPP.36.444V1160-2015		11.6.0 May 15	<a href="https://www.atis.org/docstore/default.aspx">https://www.atis.org/docstore/default.aspx</a>
CCSA	CCSA-TSD-LTE-36.444		11.6.0 Apr 15	<a href="http://www.ccsa.org.cn/ITU_spec/ITU-R/M.2012/M.2012-2/LTE/Rel-11/CCSA-TSD-LTE-36444-b60.zip">http://www.ccsa.org.cn/ITU_spec/ITU-R/M.2012/M.2012-2/LTE/Rel-11/CCSA-TSD-LTE-36444-b60.zip</a>
ETSI	ETSI TS 136 444		11.6.0 Jul 13	<a href="http://www.etsi.org/deliver/etsi_ts/136400_136499/136444/11.06.00_60/ts_136444v110600p.pdf">http://www.etsi.org/deliver/etsi_ts/136400_136499/136444/11.06.00_60/ts_136444v110600p.pdf</a>
TTA	TTAT.3G-36.444(R11-11.5.0)		11.5.0 Aug 13	<a href="http://www.tta.or.kr/data/ttasDown.jsp?where=14688&amp;pk_num=TTAT.3G-36.444(R11-11.5.0)">http://www.tta.or.kr/data/ttasDown.jsp?where=14688&amp;pk_num=TTAT.3G-36.444(R11-11.5.0)</a>
TTC	TS-3GA-36.444(Rel11)v11.6.0		11.6.0 Aug 13	<a href="http://www.ttc.or.jp/jp/document_list/free/3gpps2013/TS/TS-3GA-36.444(Rel11)v11.6.0.pdf">http://www.ttc.or.jp/jp/document_list/free/3gpps2013/TS/TS-3GA-36.444(Rel11)v11.6.0.pdf</a>
<b>Release 12</b>				
ARIB	Not applicable			
ATIS	ATIS.3GPP.36.444V1210-2015		12.1.0 May 15	<a href="https://www.atis.org/docstore/default.aspx">https://www.atis.org/docstore/default.aspx</a>
CCSA	CCSA-TSD-LTE-36.444		12.1.0 Apr 15	<a href="http://www.ccsa.org.cn/ITU_spec/ITU-R/M.2012/M.2012-2/LTE/Rel-12/CCSA-TSD-LTE-36444-c10.zip">http://www.ccsa.org.cn/ITU_spec/ITU-R/M.2012/M.2012-2/LTE/Rel-12/CCSA-TSD-LTE-36444-c10.zip</a>
ETSI	ETSI TS 136 444		12.1.0 Sep 14	<a href="http://www.etsi.org/deliver/etsi_ts/136400_136499/136444/12.01.00_60/ts_136444v120100p.pdf">http://www.etsi.org/deliver/etsi_ts/136400_136499/136444/12.01.00_60/ts_136444v120100p.pdf</a>
TTA	TTAT.3G-36.444(R12-12.1.0)		12.1.0 Apr 15	<a href="http://www.tta.or.kr/data/ttasDown.jsp?where=14688&amp;pk_num=TTAT.3G-36.444(R12-12.1.0)">http://www.tta.or.kr/data/ttasDown.jsp?where=14688&amp;pk_num=TTAT.3G-36.444(R12-12.1.0)</a>
TTC	TS-3GA-36.444(Rel12)v12.1.0		12.1.0 Mar 15	<a href="http://www.ttc.or.jp/jp/document_list/free/3gpps2015/TS/TS-3GA-36.444(Rel12)v12.1.0.pdf">http://www.ttc.or.jp/jp/document_list/free/3gpps2015/TS/TS-3GA-36.444(Rel12)v12.1.0.pdf</a>

**1.2.1.4.18 TS 36.445****Evolved Universal Terrestrial Radio Access Network (E-UTRAN); M1 data transport**

This document specifies the standards for user data transport protocols over the E-UTRAN M1 interface.

SDO (2)	Document No.	Version	Issued date	Location (1)
<b>Release 10</b>				
ARIB	Not applicable			
ATIS	ATIS.3GPP.36.445V1010-2011		10.1.0 Jul 11	<a href="https://www.atis.org/docstore/default.aspx">https://www.atis.org/docstore/default.aspx</a>
CCSA	CCSA-TSD-LTE-36.445		10.1.0 Apr 15	<a href="http://www.ccsa.org.cn/ITU_spec/ITU-R/M.2012/M.2012-2/LTE/Rel-10/CCSA-TSD-LTE-36445-a10.zip">http://www.ccsa.org.cn/ITU_spec/ITU-R/M.2012/M.2012-2/LTE/Rel-10/CCSA-TSD-LTE-36445-a10.zip</a>
ETSI	ETSI TS 136 445		10.1.0 Jun 11	<a href="http://www.etsi.org/deliver/etsi_ts/136400_136499/136445/10.01.00_60/ts_136445v100100p.pdf">http://www.etsi.org/deliver/etsi_ts/136400_136499/136445/10.01.00_60/ts_136445v100100p.pdf</a>
TTC	TS-3GA-36.445(Rel10)v10.1.0		10.1.0 Jun 11	<a href="http://www.ttc.or.jp/jp/document_list/free/3gpps2011/TS/TS-3GA-36.445(Rel10)v10.1.0.pdf">http://www.ttc.or.jp/jp/document_list/free/3gpps2011/TS/TS-3GA-36.445(Rel10)v10.1.0.pdf</a>
<b>Release 11</b>				
ARIB	Not applicable			
ATIS	ATIS.3GPP.36.445V1100-2013		11.0.0 Jun 13	<a href="https://www.atis.org/docstore/default.aspx">https://www.atis.org/docstore/default.aspx</a>

CCSA	CCSA-TSD-LTE-36.445	11.0.0	Apr 15	<a href="http://www.ccsa.org.cn/ITU_spec/ITU-R/M.2012/M.2012-2/LTE/Rel-11/CCSA-TSD-LTE-36445-b00.zip">http://www.ccsa.org.cn/ITU_spec/ITU-R/M.2012/M.2012-2/LTE/Rel-11/CCSA-TSD-LTE-36445-b00.zip</a>
ETSI	ETSI TS 136 445	11.0.0	Oct 12	<a href="http://www.etsi.org/deliver/etsi_ts/136400_136499/136445/11.00.00_60/ts_136445v110000p.pdf">http://www.etsi.org/deliver/etsi_ts/136400_136499/136445/11.00.00_60/ts_136445v110000p.pdf</a>
TTA	TTAT.3G-36.445(R11-11.0.0)	11.0.0	Aug 13	<a href="http://www.tta.or.kr/data/ttasDown.jsp?where=14688&amp;pk_num=TTAT.3G-36.445(R11-11.0.0)">http://www.tta.or.kr/data/ttasDown.jsp?where=14688&amp;pk_num=TTAT.3G-36.445(R11-11.0.0)</a>
TTC	TS-3GA-36.445(Rel11)v11.0.0	11.0.0	Jun 13	<a href="http://www.ttc.or.jp/jp/document_list/free/3gpps2013/TS/TS-3GA-36.445(Rel11)v11.0.0.pdf">http://www.ttc.or.jp/jp/document_list/free/3gpps2013/TS/TS-3GA-36.445(Rel11)v11.0.0.pdf</a>

**Release 12**

ARIB	Not applicable			
ATIS	ATIS.3GPP.36.445V1200-2015	12.0.0	May 15	<a href="https://www.atis.org/docstore/default.aspx">https://www.atis.org/docstore/default.aspx</a>
CCSA	CCSA-TSD-LTE-36.445	12.0.0	Apr 15	<a href="http://www.ccsa.org.cn/ITU_spec/ITU-R/M.2012/M.2012-2/LTE/Rel-12/CCSA-TSD-LTE-36445-c00.zip">http://www.ccsa.org.cn/ITU_spec/ITU-R/M.2012/M.2012-2/LTE/Rel-12/CCSA-TSD-LTE-36445-c00.zip</a>
ETSI	ETSI TS 136 445	12.0.0	Sep 14	<a href="http://www.etsi.org/deliver/etsi_ts/136400_136499/136445/12.00.00_60/ts_136445v120000p.pdf">http://www.etsi.org/deliver/etsi_ts/136400_136499/136445/12.00.00_60/ts_136445v120000p.pdf</a>
TTA	TTAT.3G-36.445(R12-12.0.0)	12.0.0	Apr 15	<a href="http://www.tta.or.kr/data/ttasDown.jsp?where=14688&amp;pk_num=TTAT.3G-36.445(R12-12.0.0)">http://www.tta.or.kr/data/ttasDown.jsp?where=14688&amp;pk_num=TTAT.3G-36.445(R12-12.0.0)</a>
TTC	TS-3GA-36.445(Rel12)v12.0.0	12.0.0	Mar 15	<a href="http://www.ttc.or.jp/jp/document_list/free/3gpps2015/TS/TS-3GA-36.445(Rel12)v12.0.0.pdf">http://www.ttc.or.jp/jp/document_list/free/3gpps2015/TS/TS-3GA-36.445(Rel12)v12.0.0.pdf</a>

**1.2.1.4.19 TS 36.455**

**Evolved Universal Terrestrial Radio Access (E-UTRA); LTE Positioning Protocol A (LPPa)**

This document specifies the control plane radio network layer signalling procedures between eNodeB and E-SMLC. LPPa supports the concerned functions by signalling procedures defined in this document.

SDO (2)	Document No.	Version	Issued date	Location (1)
<b>Release 10</b>				
ARIB	Not applicable			
ATIS	ATIS.3GPP.36.455V1040-2013	10.4.0	Jun 13	<a href="https://www.atis.org/docstore/default.aspx">https://www.atis.org/docstore/default.aspx</a>
CCSA	CCSA-TSD-LTE-36.455	10.4.0	Apr 15	<a href="http://www.ccsa.org.cn/ITU_spec/ITU-R/M.2012/M.2012-2/LTE/Rel-10/CCSA-TSD-LTE-36455-a40.zip">http://www.ccsa.org.cn/ITU_spec/ITU-R/M.2012/M.2012-2/LTE/Rel-10/CCSA-TSD-LTE-36455-a40.zip</a>
ETSI	ETSI TS 136 455	10.4.0	Oct 12	<a href="http://www.etsi.org/deliver/etsi_ts/136400_136499/136455/10.04.00_60/ts_136455v100400p.pdf">http://www.etsi.org/deliver/etsi_ts/136400_136499/136455/10.04.00_60/ts_136455v100400p.pdf</a>
TTC	TS-3GA-36.455(Rel10)v10.4.0	10.4.0	Dec 12	<a href="http://www.ttc.or.jp/jp/document_list/free/3gpps2012/TS/TS-3GA-36.455(Rel10)v10.4.0.pdf">http://www.ttc.or.jp/jp/document_list/free/3gpps2012/TS/TS-3GA-36.455(Rel10)v10.4.0.pdf</a>
<b>Release 11</b>				
ARIB	Not applicable			
ATIS	ATIS.3GPP.36.455V1130-2015	11.3.0	May 15	<a href="https://www.atis.org/docstore/default.aspx">https://www.atis.org/docstore/default.aspx</a>
CCSA	CCSA-TSD-LTE-36.455	11.3.0	Apr 15	<a href="http://www.ccsa.org.cn/ITU_spec/ITU-R/M.2012/M.2012-2/LTE/Rel-11/CCSA-TSD-LTE-36455-b30.zip">http://www.ccsa.org.cn/ITU_spec/ITU-R/M.2012/M.2012-2/LTE/Rel-11/CCSA-TSD-LTE-36455-b30.zip</a>
ETSI	ETSI TS 136 455	11.3.0	Jul 13	<a href="http://www.etsi.org/deliver/etsi_ts/136400_136499/136455/11.03.00_60/ts_136455v110300p.pdf">http://www.etsi.org/deliver/etsi_ts/136400_136499/136455/11.03.00_60/ts_136455v110300p.pdf</a>
TTA	TTAT.3G-36.455(R11-11.2.0)	11.2.0	Aug 13	<a href="http://www.tta.or.kr/data/ttasDown.jsp?where=14688&amp;pk_num=TTAT.3G-36.455(R11-11.2.0)">http://www.tta.or.kr/data/ttasDown.jsp?where=14688&amp;pk_num=TTAT.3G-36.455(R11-11.2.0)</a>
TTC	TS-3GA-36.455(Rel11)v11.3.0	11.3.0	Aug 13	<a href="http://www.ttc.or.jp/jp/document_list/free/3gpps2013/TS/TS-3GA-36.455(Rel11)v11.3.0.pdf">http://www.ttc.or.jp/jp/document_list/free/3gpps2013/TS/TS-3GA-36.455(Rel11)v11.3.0.pdf</a>
<b>Release 12</b>				
ARIB	Not applicable			
ATIS	ATIS.3GPP.36.455V1210-2015	12.1.0	May 15	<a href="https://www.atis.org/docstore/default.aspx">https://www.atis.org/docstore/default.aspx</a>
CCSA	CCSA-TSD-LTE-36.455	12.1.0	Apr 15	<a href="http://www.ccsa.org.cn/ITU_spec/ITU-R/M.2012/M.2012-2/LTE/Rel-11/CCSA-TSD-LTE-36455-c10.zip">http://www.ccsa.org.cn/ITU_spec/ITU-R/M.2012/M.2012-2/LTE/Rel-11/CCSA-TSD-LTE-36455-c10.zip</a>
ETSI	ETSI TS 136 455	12.1.0	Feb 15	<a href="http://www.etsi.org/deliver/etsi_ts/136400_136499/136455/12.01.00_60/ts_136455v120100p.pdf">http://www.etsi.org/deliver/etsi_ts/136400_136499/136455/12.01.00_60/ts_136455v120100p.pdf</a>
TTA	TTAT.3G-36.455(R12-12.1.0)	12.1.0	Apr 15	<a href="http://www.tta.or.kr/data/ttasDown.jsp?where=14688&amp;pk_num=TTAT.3G-36.455(R12-12.1.0)">http://www.tta.or.kr/data/ttasDown.jsp?where=14688&amp;pk_num=TTAT.3G-36.455(R12-12.1.0)</a>
TTC	TS-3GA-36.455(Rel12)v12.1.0	12.1.0	Mar 15	<a href="http://www.ttc.or.jp/jp/document_list/free/3gpps2015/TS/TS-3GA-36.455(Rel12)v12.1.0.pdf">http://www.ttc.or.jp/jp/document_list/free/3gpps2015/TS/TS-3GA-36.455(Rel12)v12.1.0.pdf</a>

## 1.2.1.4.20 TS 36.456

**SLm interface general aspects and principles**

This document is an introduction to the 3GPP TS 36.45x series of technical specifications that define the SLm interface for the interconnection of the Evolved Serving Mobile Location Centre (E-SMLC) to the Location Measurement Unit (LMU) components of the Evolved Universal Terrestrial Radio Access Network (E-UTRAN).

**SDO (2) Document No. Version Issued date Location (1)**

**Release 10 (not applicable – this specification added beginning with Release 11)**

**Release 11**

ARIB	Not applicable				
ATIS	ATIS.3GPP.36.456V1100-2013	11.0.0	Jun 13		<a href="https://www.atis.org/docstore/default.aspx">https://www.atis.org/docstore/default.aspx</a>
CCSA	CCSA-TSD-LTE-36.456	11.0.0	Apr 15		<a href="http://www.ccsa.org.cn/ITU_spec/ITU-R/M.2012/M.2012-2/LTE/Rel-11/CCSA-TSD-LTE-36456-b00.zip">http://www.ccsa.org.cn/ITU_spec/ITU-R/M.2012/M.2012-2/LTE/Rel-11/CCSA-TSD-LTE-36456-b00.zip</a>
ETSI	ETSI TS 136 456	11.0.0	Feb 13		<a href="http://www.etsi.org/deliver/etsi_ts/136400_136499/136456/11.00.00_60/ts_136456v110000p.pdf">http://www.etsi.org/deliver/etsi_ts/136400_136499/136456/11.00.00_60/ts_136456v110000p.pdf</a>
TTA	TTAT.3G-36.456(R11-11.0.0)	11.0.0	Aug 13		<a href="http://www.tta.or.kr/data/ttasDown.jsp?where=14688&amp;pk_num=TTAT.3G-36.456(R11-11.0.0)">http://www.tta.or.kr/data/ttasDown.jsp?where=14688&amp;pk_num=TTAT.3G-36.456(R11-11.0.0)</a>
TTC	TS-3GA-36.456(Rel11)v11.0.0	11.0.0	Jun 13		<a href="http://www.ttc.or.jp/jp/document_list/free/3gpps2013/TS/TS-3GA-36.456(Rel11)v11.0.0.pdf">http://www.ttc.or.jp/jp/document_list/free/3gpps2013/TS/TS-3GA-36.456(Rel11)v11.0.0.pdf</a>

**Release 12**

ARIB	Not applicable				
ATIS	ATIS.3GPP.36.456V1200-2015	12.0.0	May 15		<a href="https://www.atis.org/docstore/default.aspx">https://www.atis.org/docstore/default.aspx</a>
CCSA	CCSA-TSD-LTE-36.456	12.0.0	Apr 15		<a href="http://www.ccsa.org.cn/ITU_spec/ITU-R/M.2012/M.2012-2/LTE/Rel-12/CCSA-TSD-LTE-36456-c00.zip">http://www.ccsa.org.cn/ITU_spec/ITU-R/M.2012/M.2012-2/LTE/Rel-12/CCSA-TSD-LTE-36456-c00.zip</a>
ETSI	ETSI TS 136 456	12.0.0	Sep 14		<a href="http://www.etsi.org/deliver/etsi_ts/136400_136499/136456/12.00.00_60/ts_136456v120000p.pdf">http://www.etsi.org/deliver/etsi_ts/136400_136499/136456/12.00.00_60/ts_136456v120000p.pdf</a>
TTA	TTAT.3G-36.456(R12-12.0.0)	12.0.0	Apr 15		<a href="http://www.tta.or.kr/data/ttasDown.jsp?where=14688&amp;pk_num=TTAT.3G-36.456(R12-12.0.0)">http://www.tta.or.kr/data/ttasDown.jsp?where=14688&amp;pk_num=TTAT.3G-36.456(R12-12.0.0)</a>
TTC	TS-3GA-36.456(Rel12)v12.0.0	12.0.0	Mar 15		<a href="http://www.ttc.or.jp/jp/document_list/free/3gpps2015/TS/TS-3GA-36.456(Rel12)v12.0.0.pdf">http://www.ttc.or.jp/jp/document_list/free/3gpps2015/TS/TS-3GA-36.456(Rel12)v12.0.0.pdf</a>

## 1.2.1.4.21 TS 36.457

**SLm interface layer 1**

This document specifies the standards allowed to implement layer 1 on the SLm interface.

**SDO (2) Document No. Version Issued date Location (1)**

**Release 10 (not applicable – this specification added beginning with Release 11)**

**Release 11**

ARIB	Not applicable				
ATIS	ATIS.3GPP.36.457V1100-2013	11.0.0	Jun 13		<a href="https://www.atis.org/docstore/default.aspx">https://www.atis.org/docstore/default.aspx</a>
CCSA	CCSA-TSD-LTE-36.457	11.0.0	Apr 15		<a href="http://www.ccsa.org.cn/ITU_spec/ITU-R/M.2012/M.2012-2/LTE/Rel-11/CCSA-TSD-LTE-36457-b00.zip">http://www.ccsa.org.cn/ITU_spec/ITU-R/M.2012/M.2012-2/LTE/Rel-11/CCSA-TSD-LTE-36457-b00.zip</a>
ETSI	ETSI TS 136 457	11.0.0	Feb 13		<a href="http://www.etsi.org/deliver/etsi_ts/136400_136499/136457/11.00.00_60/ts_136457v110000p.pdf">http://www.etsi.org/deliver/etsi_ts/136400_136499/136457/11.00.00_60/ts_136457v110000p.pdf</a>
TTA	TTAT.3G-36.457(R11-11.0.0)	11.0.0	Aug 13		<a href="http://www.tta.or.kr/data/ttasDown.jsp?where=14688&amp;pk_num=TTAT.3G-36.457(R11-11.0.0)">http://www.tta.or.kr/data/ttasDown.jsp?where=14688&amp;pk_num=TTAT.3G-36.457(R11-11.0.0)</a>
TTC	TS-3GA-36.457(Rel11)v11.0.0	11.0.0	Jun 13		<a href="http://www.ttc.or.jp/jp/document_list/free/3gpps2013/TS/TS-3GA-36.457(Rel11)v11.0.0.pdf">http://www.ttc.or.jp/jp/document_list/free/3gpps2013/TS/TS-3GA-36.457(Rel11)v11.0.0.pdf</a>

**Release 12**

ARIB	Not applicable				
ATIS	ATIS.3GPP.36.457V1200-2015	12.0.0	May 15		<a href="https://www.atis.org/docstore/default.aspx">https://www.atis.org/docstore/default.aspx</a>
CCSA	CCSA-TSD-LTE-36.457	12.0.0	Apr 15		<a href="http://www.ccsa.org.cn/ITU_spec/ITU-R/M.2012/M.2012-2/LTE/Rel-12/CCSA-TSD-LTE-36457-c00.zip">http://www.ccsa.org.cn/ITU_spec/ITU-R/M.2012/M.2012-2/LTE/Rel-12/CCSA-TSD-LTE-36457-c00.zip</a>



ETSI	ETSI TS 136 457	12.0.0	Sep 14	<a href="http://www.etsi.org/deliver/etsi_ts/136400_136499/136457/12.00.00_60/ts_136457v120000p.pdf">http://www.etsi.org/deliver/etsi_ts/136400_136499/136457/12.00.00_60/ts_136457v120000p.pdf</a>
TTA	TTAT.3G-36.457(R12-12.0.0)	12.0.0	Apr 15	<a href="http://www.tta.or.kr/data/ttasDown.jsp?where=14688&amp;pk_num=TTAT.3G-36.457(R12-12.0.0)">http://www.tta.or.kr/data/ttasDown.jsp?where=14688&amp;pk_num=TTAT.3G-36.457(R12-12.0.0)</a>
TTC	TS-3GA-36.457(Rel12)v12.0.0	12.0.0	Mar 15	<a href="http://www.ttc.or.jp/jp/document_list/free/3gpps2015/TS/TS-3GA-36.457(Rel12)v12.0.0.pdf">http://www.ttc.or.jp/jp/document_list/free/3gpps2015/TS/TS-3GA-36.457(Rel12)v12.0.0.pdf</a>

### 1.2.1.4.22 TS 36.458

#### SLm interface signalling transport

This document specifies the standards for signalling transport to be used across the SLm interface. The SLm interface is a logical interface between the LMU and the E-SMLC in the E-UTRAN core network. This document describes how the SLmAP signalling messages are transported over SLm.

**SDO (2) Document No. Version Issued date Location (1)**

**Release 10 (not applicable – this specification added beginning with Release 11)**

#### Release 11

ARIB	Not applicable			
ATIS	ATIS.3GPP.36.458V1100-2013	11.0.0	Jun 13	<a href="https://www.atis.org/docstore/default.aspx">https://www.atis.org/docstore/default.aspx</a>
CCSA	CCSA-TSD-LTE-36.458	11.0.0	Apr 15	<a href="http://www.ccsa.org.cn/ITU_spec/ITU-R/M.2012/M.2012-2/LTE/Rel-11/CCSA-TSD-LTE-36458-b00.zip">http://www.ccsa.org.cn/ITU_spec/ITU-R/M.2012/M.2012-2/LTE/Rel-11/CCSA-TSD-LTE-36458-b00.zip</a>
ETSI	ETSI TS 136 458	11.0.0	Feb 13	<a href="http://www.etsi.org/deliver/etsi_ts/136400_136499/136458/11.00.00_60/ts_136458v110000p.pdf">http://www.etsi.org/deliver/etsi_ts/136400_136499/136458/11.00.00_60/ts_136458v110000p.pdf</a>
TTA	TTAT.3G-36.458(R11-11.0.0)	11.0.0	Aug 13	<a href="http://www.tta.or.kr/data/ttasDown.jsp?where=14688&amp;pk_num=TTAT.3G-36.458(R11-11.0.0)">http://www.tta.or.kr/data/ttasDown.jsp?where=14688&amp;pk_num=TTAT.3G-36.458(R11-11.0.0)</a>
TTC	TS-3GA-36.458(Rel11)v11.0.0	11.0.0	Jun 13	<a href="http://www.ttc.or.jp/jp/document_list/free/3gpps2013/TS/TS-3GA-36.458(Rel11)v11.0.0.pdf">http://www.ttc.or.jp/jp/document_list/free/3gpps2013/TS/TS-3GA-36.458(Rel11)v11.0.0.pdf</a>

#### Release 12

ARIB	Not applicable			
ATIS	ATIS.3GPP.36.458V1200-2015	12.0.0	May 15	<a href="https://www.atis.org/docstore/default.aspx">https://www.atis.org/docstore/default.aspx</a>
CCSA	CCSA-TSD-LTE-36.458	12.0.0	Apr 15	<a href="http://www.ccsa.org.cn/ITU_spec/ITU-R/M.2012/M.2012-2/LTE/Rel-12/CCSA-TSD-LTE-36458-c00.zip">http://www.ccsa.org.cn/ITU_spec/ITU-R/M.2012/M.2012-2/LTE/Rel-12/CCSA-TSD-LTE-36458-c00.zip</a>
ETSI	ETSI TS 136 458	12.0.0	Sep 14	<a href="http://www.etsi.org/deliver/etsi_ts/136400_136499/136458/12.00.00_60/ts_136458v120000p.pdf">http://www.etsi.org/deliver/etsi_ts/136400_136499/136458/12.00.00_60/ts_136458v120000p.pdf</a>
TTA	TTAT.3G-36.458(R12-12.0.0)	12.0.0	Apr 15	<a href="http://www.tta.or.kr/data/ttasDown.jsp?where=14688&amp;pk_num=TTAT.3G-36.458(R12-12.0.0)">http://www.tta.or.kr/data/ttasDown.jsp?where=14688&amp;pk_num=TTAT.3G-36.458(R12-12.0.0)</a>
TTC	TS-3GA-36.458(Rel12)v12.0.0	12.0.0	Mar 15	<a href="http://www.ttc.or.jp/jp/document_list/free/3gpps2015/TS/TS-3GA-36.458(Rel12)v12.0.0.pdf">http://www.ttc.or.jp/jp/document_list/free/3gpps2015/TS/TS-3GA-36.458(Rel12)v12.0.0.pdf</a>

### 1.2.1.4.23 TS 36.459

#### SLm interface Application Protocol (SLmAP)

This document specifies the E-UTRAN radio network layer signalling protocol for the SLm interface. The SLm Application Protocol (SLmAP) supports the functions of the SLm interface by signalling procedures defined in this document.

**SDO (2) Document No. Version Issued date Location (1)**

**Release 10 (not applicable – this specification added beginning with Release 11)**

#### Release 11

ARIB	Not applicable			
ATIS	ATIS.3GPP.36.459V1130-2015	11.3.0	May 15	<a href="https://www.atis.org/docstore/default.aspx">https://www.atis.org/docstore/default.aspx</a>
CCSA	CCSA-TSD-LTE-36.459	11.3.0	Apr 15	<a href="http://www.ccsa.org.cn/ITU_spec/ITU-R/M.2012/M.2012-2/LTE/Rel-11/CCSA-TSD-LTE-36459-b10.zip">http://www.ccsa.org.cn/ITU_spec/ITU-R/M.2012/M.2012-2/LTE/Rel-11/CCSA-TSD-LTE-36459-b10.zip</a>
ETSI	ETSI TS 136 459	11.3.0	Sep 13	<a href="http://www.etsi.org/deliver/etsi_ts/136400_136499/136459/11.03.00_60/ts_136459v110300p.pdf">http://www.etsi.org/deliver/etsi_ts/136400_136499/136459/11.03.00_60/ts_136459v110300p.pdf</a>
TTA	TTAT.3G-36.459(R11-11.1.0)	11.1.0	Aug 13	<a href="http://www.tta.or.kr/data/ttasDown.jsp?where=14688&amp;pk_num=TTAT.3G-36.459(R11-11.1.0)">http://www.tta.or.kr/data/ttasDown.jsp?where=14688&amp;pk_num=TTAT.3G-36.459(R11-11.1.0)</a>
TTC	TS-3GA-36.459(Rel11)v11.3.0	11.3.0	Dec 13	<a href="http://www.ttc.or.jp/jp/document_list/free/3gpps2013/TS/TS-3GA-36.459(Rel11)v11.3.0.pdf">http://www.ttc.or.jp/jp/document_list/free/3gpps2013/TS/TS-3GA-36.459(Rel11)v11.3.0.pdf</a>

**Release 12**

ARIB	Not applicable				
ATIS	ATIS.3GPP.36.459V1200-2015	12.0.0	May 15	<a href="https://www.atis.org/docstore/default.aspx">https://www.atis.org/docstore/default.aspx</a>	
CCSA	CCSA-TSD-LTE-36.459	12.0.0	Apr 15	<a href="http://www.ccsa.org.cn/ITU_spec/ITU-R/M.2012/M.2012-2/LTE/Rel-12/CCSA-TSD-LTE-36459-c00.zip">http://www.ccsa.org.cn/ITU_spec/ITU-R/M.2012/M.2012-2/LTE/Rel-12/CCSA-TSD-LTE-36459-c00.zip</a>	
ETSI	ETSI TS 136 459	12.0.0	Sep 14	<a href="http://www.etsi.org/deliver/etsi_ts/136400_136499/136459/12.00.00_60/ts_136459v120000p.pdf">http://www.etsi.org/deliver/etsi_ts/136400_136499/136459/12.00.00_60/ts_136459v120000p.pdf</a>	
TTA	TTAT.3G-36.459(R12-12.0.0)	12.0.0	Apr 15	<a href="http://www.tta.or.kr/data/ttasDown.jsp?where=14688&amp;pk_num=TTAT.3G-36.459(R12-12.0.0)">http://www.tta.or.kr/data/ttasDown.jsp?where=14688&amp;pk_num=TTAT.3G-36.459(R12-12.0.0)</a>	
TTC	TS-3GA-36.459(Rel12)v12.0.0	12.0.0	Mar 15	<a href="http://www.ttc.or.jp/jp/document_list/free/3gpps2015/TS/TS-3GA-36.459(Rel12)v12.0.0.pdf">http://www.ttc.or.jp/jp/document_list/free/3gpps2015/TS/TS-3GA-36.459(Rel12)v12.0.0.pdf</a>	

**1.2.1.4.24 TS 25.460****UTRAN Iuant interface: General aspects and principles**

This document is an introduction to the 3GPP TS 25.46x series of technical specifications that define the Iuant Interface for UMTS and E-UTRAN. The logical Iuant interface is a NodeB/eNodeB internal interface between the implementation specific O&M function and the RET antennas and TMAs control unit function of the NodeB/eNodeB.

**SDO (2) Document No. Version Issued date Location (1)****Release 10**

ARIB	ARIB STD-T104-25.460	10.0.1	Sep 11	<a href="http://www.arib.or.jp/english/html/overview/doc/STD-T104v1_00/2_T104/ARIB-STD-T104/Rel10/25/A25460-a01.pdf">http://www.arib.or.jp/english/html/overview/doc/STD-T104v1_00/2_T104/ARIB-STD-T104/Rel10/25/A25460-a01.pdf</a>
ATIS	ATIS.3GPP.25.460V1001-2011	10.0.1	Jul 11	<a href="https://www.atis.org/docstore/default.aspx">https://www.atis.org/docstore/default.aspx</a>
CCSA	CCSA-TSD-LTE-25.460	10.0.1	Apr 15	<a href="http://www.ccsa.org.cn/ITU_spec/ITU-R/M.2012/M.2012-2/LTE/Rel-10/CCSA-TSD-LTE-25460-a01.zip">http://www.ccsa.org.cn/ITU_spec/ITU-R/M.2012/M.2012-2/LTE/Rel-10/CCSA-TSD-LTE-25460-a01.zip</a>
ETSI	ETSI TS 125 460	10.0.1	Apr 11	<a href="http://www.etsi.org/deliver/etsi_ts/125400_125499/125460/10.00.01_60/ts_125460v100001p.pdf">http://www.etsi.org/deliver/etsi_ts/125400_125499/125460/10.00.01_60/ts_125460v100001p.pdf</a>
TTC	Not applicable			

**Release 11**

ARIB	ARIB STD-T104-25.460	11.0.0	Jul 13	<a href="http://www.arib.or.jp/english/html/overview/doc/STD-T104v2_00/2_T104/ARIB-STD-T104/Rel11/25/A25460-b00.pdf">http://www.arib.or.jp/english/html/overview/doc/STD-T104v2_00/2_T104/ARIB-STD-T104/Rel11/25/A25460-b00.pdf</a>
ATIS	ATIS.3GPP.25.460V1100-2013	11.0.0	Jun 13	<a href="https://www.atis.org/docstore/default.aspx">https://www.atis.org/docstore/default.aspx</a>
CCSA	CCSA-TSD-LTE-25.460	11.0.0	Apr 15	<a href="http://www.ccsa.org.cn/ITU_spec/ITU-R/M.2012/M.2012-2/LTE/Rel-11/CCSA-TSD-LTE-25460-b00.zip">http://www.ccsa.org.cn/ITU_spec/ITU-R/M.2012/M.2012-2/LTE/Rel-11/CCSA-TSD-LTE-25460-b00.zip</a>
ETSI	ETSI TS 125 460	11.0.0	Oct 12	<a href="http://www.etsi.org/deliver/etsi_ts/125400_125499/125460/11.00.00_60/ts_125460v110000p.pdf">http://www.etsi.org/deliver/etsi_ts/125400_125499/125460/11.00.00_60/ts_125460v110000p.pdf</a>
TTA	TTAT.3G-25.460(R11-11.0.0)	11.0.0	Aug 13	<a href="http://www.tta.or.kr/data/ttasDown.jsp?where=14688&amp;pk_num=TTAT.3G-25.460(R11-11.0.0)">http://www.tta.or.kr/data/ttasDown.jsp?where=14688&amp;pk_num=TTAT.3G-25.460(R11-11.0.0)</a>
TTC	Not applicable			

**Release 12**

ARIB	Not applicable			
ATIS	ATIS.3GPP.25.460V1200-2015	12.0.0	May 15	<a href="https://www.atis.org/docstore/default.aspx">https://www.atis.org/docstore/default.aspx</a>
CCSA	CCSA-TSD-LTE-25.460	12.0.0	Apr 15	<a href="http://www.ccsa.org.cn/ITU_spec/ITU-R/M.2012/M.2012-2/LTE/Rel-12/CCSA-TSD-LTE-25460-c00.zip">http://www.ccsa.org.cn/ITU_spec/ITU-R/M.2012/M.2012-2/LTE/Rel-12/CCSA-TSD-LTE-25460-c00.zip</a>
ETSI	ETSI TS 125 460	12.0.0	Sep 14	<a href="http://www.etsi.org/deliver/etsi_ts/125400_125499/125460/12.00.00_60/ts_125460v120000p.pdf">http://www.etsi.org/deliver/etsi_ts/125400_125499/125460/12.00.00_60/ts_125460v120000p.pdf</a>
TTA	TTAT.3G-25.460(R12-12.0.0)	12.0.0	Apr 15	<a href="http://www.tta.or.kr/data/ttasDown.jsp?where=14688&amp;pk_num=TTAT.3G-25.460(R12-12.0.0)">http://www.tta.or.kr/data/ttasDown.jsp?where=14688&amp;pk_num=TTAT.3G-25.460(R12-12.0.0)</a>
TTC	Not applicable			

**1.2.1.4.25 TS 25.461****UTRAN Iuant interface: Layer 1**

This document specifies the standards allowed to implement layer 1 on the Iuant interface. The specification of transmission delay requirements and O&M requirements are not in the scope of this document.

SDO (2)	Document No.	Version	Issued date	Location (1)
<b>Release 10</b>				
ARIB	ARIB STD-T104-25.461		10.3.0 Jul 12	<a href="http://www.arib.or.jp/english/html/overview/doc/STD-T104v1_20/2_T104/ARIB-STD-T104/Rel10/25/A25461-a30.pdf">http://www.arib.or.jp/english/html/overview/doc/STD-T104v1_20/2_T104/ARIB-STD-T104/Rel10/25/A25461-a30.pdf</a>
ATIS	ATIS.3GPP.25.461V1030-2013		10.3.0 Jun 13	<a href="https://www.atis.org/docstore/default.aspx">https://www.atis.org/docstore/default.aspx</a>
CCSA	CCSA-TSD-LTE-25.461		10.3.0 Apr 15	<a href="http://www.ccsa.org.cn/ITU_spec/ITU-R/M.2012/M.2012-2/LTE/Rel-10/CCSA-TSD-LTE-25461-a30.zip">http://www.ccsa.org.cn/ITU_spec/ITU-R/M.2012/M.2012-2/LTE/Rel-10/CCSA-TSD-LTE-25461-a30.zip</a>
ETSI	ETSI TS 125 461		10.3.0 Jan 12	<a href="http://www.etsi.org/deliver/etsi_ts/125400_125499/125461/10.03.00_60/ts_125461v100300p.pdf">http://www.etsi.org/deliver/etsi_ts/125400_125499/125461/10.03.00_60/ts_125461v100300p.pdf</a>
TTC	Not applicable			
<b>Release 11</b>				
ARIB	ARIB STD-T104-25.461		11.2.0 Jul 13	<a href="http://www.arib.or.jp/english/html/overview/doc/STD-T104v2_00/2_T104/ARIB-STD-T104/Rel11/25/A25461-b20.pdf">http://www.arib.or.jp/english/html/overview/doc/STD-T104v2_00/2_T104/ARIB-STD-T104/Rel11/25/A25461-b20.pdf</a>
ATIS	ATIS.3GPP.25.461V1120-2013		11.2.0 Jun 13	<a href="https://www.atis.org/docstore/default.aspx">https://www.atis.org/docstore/default.aspx</a>
CCSA	CCSA-TSD-LTE-25.461		11.2.0 Apr 15	<a href="http://www.ccsa.org.cn/ITU_spec/ITU-R/M.2012/M.2012-2/LTE/Rel-11/CCSA-TSD-LTE-25461-b20.zip">http://www.ccsa.org.cn/ITU_spec/ITU-R/M.2012/M.2012-2/LTE/Rel-11/CCSA-TSD-LTE-25461-b20.zip</a>
ETSI	ETSI TS 125 461		11.2.0 Jan 13	<a href="http://www.etsi.org/deliver/etsi_ts/125400_125499/125461/11.02.00_60/ts_125461v110200p.pdf">http://www.etsi.org/deliver/etsi_ts/125400_125499/125461/11.02.00_60/ts_125461v110200p.pdf</a>
TTA	TTAT.3G-25.461(R11-11.2.0)		11.2.0 Aug 13	<a href="http://www.tta.or.kr/data/ttasDown.jsp?where=14688&amp;pk_num=TTAT.3G-25.461(R11-11.2.0)">http://www.tta.or.kr/data/ttasDown.jsp?where=14688&amp;pk_num=TTAT.3G-25.461(R11-11.2.0)</a>
TTC	Not applicable			
<b>Release 12</b>				
ARIB	Not applicable			
ATIS	ATIS.3GPP.25.461V1210-2015		12.1.0 May 15	<a href="https://www.atis.org/docstore/default.aspx">https://www.atis.org/docstore/default.aspx</a>
CCSA	CCSA-TSD-LTE-25.461		12.1.0 Apr 15	<a href="http://www.ccsa.org.cn/ITU_spec/ITU-R/M.2012/M.2012-2/LTE/Rel-12/CCSA-TSD-LTE-25461-c10.zip">http://www.ccsa.org.cn/ITU_spec/ITU-R/M.2012/M.2012-2/LTE/Rel-12/CCSA-TSD-LTE-25461-c10.zip</a>
ETSI	ETSI TS 125 461		12.1.0 Sep 14	<a href="http://www.etsi.org/deliver/etsi_ts/125400_125499/125461/12.01.00_60/ts_125461v120100p.pdf">http://www.etsi.org/deliver/etsi_ts/125400_125499/125461/12.01.00_60/ts_125461v120100p.pdf</a>
TTA	TTAT.3G-25.461(R12-12.1.0)		12.1.0 Apr 15	<a href="http://www.tta.or.kr/data/ttasDown.jsp?where=14688&amp;pk_num=TTAT.3G-25.461(R12-12.1.0)">http://www.tta.or.kr/data/ttasDown.jsp?where=14688&amp;pk_num=TTAT.3G-25.461(R12-12.1.0)</a>
TTC	Not applicable			

### 1.2.1.4.26 TS 25.462

#### UTRAN Iuant interface: Signalling transport

This document specifies the signalling transport related to RETAP and TMAAP signalling to be used across the Iuant interface. The logical Iuant interface is a NodeB/eNodeB internal interface between the implementation specific O&M function and the RET antennas and TMAs control unit function of the NodeB/eNodeB.

SDO (2)	Document No.	Version	Issued date	Location (1)
<b>Release 10</b>				
ARIB	ARIB STD-T104-25.462		10.1.0 Sep 11	<a href="http://www.arib.or.jp/english/html/overview/doc/STD-T104v1_00/2_T104/ARIB-STD-T104/Rel10/25/A25462-a10.pdf">http://www.arib.or.jp/english/html/overview/doc/STD-T104v1_00/2_T104/ARIB-STD-T104/Rel10/25/A25462-a10.pdf</a>
ATIS	ATIS.3GPP.25.462V1010-2011		10.1.0 Jul 11	<a href="https://www.atis.org/docstore/default.aspx">https://www.atis.org/docstore/default.aspx</a>
CCSA	CCSA-TSD-LTE-25.462		10.1.0 Apr 15	<a href="http://www.ccsa.org.cn/ITU_spec/ITU-R/M.2012/M.2012-2/LTE/Rel-10/CCSA-TSD-LTE-25462-a10.zip">http://www.ccsa.org.cn/ITU_spec/ITU-R/M.2012/M.2012-2/LTE/Rel-10/CCSA-TSD-LTE-25462-a10.zip</a>
ETSI	ETSI TS 125 462		10.1.0 Jun 11	<a href="http://www.etsi.org/deliver/etsi_ts/125400_125499/125462/10.01.00_60/ts_125462v100100p.pdf">http://www.etsi.org/deliver/etsi_ts/125400_125499/125462/10.01.00_60/ts_125462v100100p.pdf</a>
TTC	Not applicable			
<b>Release 11</b>				
ARIB	ARIB STD-T104-25.462		11.0.0 Jul 13	<a href="http://www.arib.or.jp/english/html/overview/doc/STD-T104v2_00/2_T104/ARIB-STD-T104/Rel11/25/A25462-b00.pdf">http://www.arib.or.jp/english/html/overview/doc/STD-T104v2_00/2_T104/ARIB-STD-T104/Rel11/25/A25462-b00.pdf</a>
ATIS	ATIS.3GPP.25.462V1100-2013		11.0.0 Jun 13	<a href="https://www.atis.org/docstore/default.aspx">https://www.atis.org/docstore/default.aspx</a>
CCSA	CCSA-TSD-LTE-25.462		11.0.0 Apr 15	<a href="http://www.ccsa.org.cn/ITU_spec/ITU-R/M.2012/M.2012-2/LTE/Rel-11/CCSA-TSD-LTE-25462-b00.zip">http://www.ccsa.org.cn/ITU_spec/ITU-R/M.2012/M.2012-2/LTE/Rel-11/CCSA-TSD-LTE-25462-b00.zip</a>
ETSI	ETSI TS 125 462		11.0.0 Oct 12	<a href="http://www.etsi.org/deliver/etsi_ts/125400_125499/125462/11.00.00_60/ts_125462v110000p.pdf">http://www.etsi.org/deliver/etsi_ts/125400_125499/125462/11.00.00_60/ts_125462v110000p.pdf</a>
TTA	TTAT.3G-25.462(R11-11.0.0)		11.0.0 Aug 13	<a href="http://www.tta.or.kr/data/ttasDown.jsp?where=14688&amp;pk_num=TTAT.3G-25.462(R11-11.0.0)">http://www.tta.or.kr/data/ttasDown.jsp?where=14688&amp;pk_num=TTAT.3G-25.462(R11-11.0.0)</a>
TTC	Not applicable			

**Release 12**

ARIB	Not applicable				
ATIS	ATIS.3GPP.25.462V1200-2015	12.0.0	May 15		<a href="https://www.atis.org/docstore/default.aspx">https://www.atis.org/docstore/default.aspx</a>
CCSA	CCSA-TSD-LTE-25.462	12.0.0	Apr 15		<a href="http://www.ccsa.org.cn/ITU_spec/ITU-R/M.2012/M.2012-2/LTE/Rel-12/CCSA-TSD-LTE-25462-c00.zip">http://www.ccsa.org.cn/ITU_spec/ITU-R/M.2012/M.2012-2/LTE/Rel-12/CCSA-TSD-LTE-25462-c00.zip</a>
ETSI	ETSI TS 125 462	12.0.0	Sep 14		<a href="http://www.etsi.org/deliver/etsi_ts/125400_125499/125462/12.00.00_60/ts_125462v120000p.pdf">http://www.etsi.org/deliver/etsi_ts/125400_125499/125462/12.00.00_60/ts_125462v120000p.pdf</a>
TTA	TTAT.3G-25.462(R12-12.0.0)	12.0.0	Apr 15		<a href="http://www.tta.or.kr/data/ttasDown.jsp?where=14688&amp;pk_num=TTAT.3G-25.462(R12-12.0.0)">http://www.tta.or.kr/data/ttasDown.jsp?where=14688&amp;pk_num=TTAT.3G-25.462(R12-12.0.0)</a>
TTC	Not applicable				

**1.2.1.4.27 TS 25.466****UTRAN Iuant interface: Application part**

This document specifies the Remote Electrical Tilting Application Part (RETAP) between the implementation specific O&M transport function and the RET Antenna Control unit function of the NodeB/eNodeB. The document also specifies the Tower Mounted Amplifier Application Part (TMAAP) between the implementation specific O&M transport function and the TMA control function of the NodeB/eNodeB. It defines the Iuant interface and its associated signalling procedures.

SDO (2)	Document No.	Version	Issued date		Location (1)
<b>Release 10</b>					
ARIB	ARIB STD-T104-25.466		10.3.0	Jul 12	<a href="http://www.arib.or.jp/english/html/overview/doc/STD-T104v1_20/2_T104/ARIB-STD-T104/Rel10/25/A25466-a30.pdf">http://www.arib.or.jp/english/html/overview/doc/STD-T104v1_20/2_T104/ARIB-STD-T104/Rel10/25/A25466-a30.pdf</a>
ATIS	ATIS.3GPP.25.466V1030-2013		10.3.0	Jun 13	<a href="https://www.atis.org/docstore/default.aspx">https://www.atis.org/docstore/default.aspx</a>
CCSA	CCSA-TSD-LTE-25.466		10.3.0	Apr 15	<a href="http://www.ccsa.org.cn/ITU_spec/ITU-R/M.2012/M.2012-2/LTE/Rel-10/CCSA-TSD-LTE-25466-a30.zip">http://www.ccsa.org.cn/ITU_spec/ITU-R/M.2012/M.2012-2/LTE/Rel-10/CCSA-TSD-LTE-25466-a30.zip</a>
ETSI	ETSI TS 125 466		10.3.0	Jan 12	<a href="http://www.etsi.org/deliver/etsi_ts/125400_125499/125466/10.03.00_60/ts_125466v100300p.pdf">http://www.etsi.org/deliver/etsi_ts/125400_125499/125466/10.03.00_60/ts_125466v100300p.pdf</a>
TTC	Not applicable				
<b>Release 11</b>					
ARIB	ARIB STD-T104-25.466		11.3.0	Jul 13	<a href="http://www.arib.or.jp/english/html/overview/doc/STD-T104v2_00/2_T104/ARIB-STD-T104/Rel11/25/A25466-b30.pdf">http://www.arib.or.jp/english/html/overview/doc/STD-T104v2_00/2_T104/ARIB-STD-T104/Rel11/25/A25466-b30.pdf</a>
ATIS	ATIS.3GPP.25.466V1130-2013		11.3.0	Jun 13	<a href="https://www.atis.org/docstore/default.aspx">https://www.atis.org/docstore/default.aspx</a>
CCSA	CCSA-TSD-LTE-25.466		11.3.0	Apr 15	<a href="http://www.ccsa.org.cn/ITU_spec/ITU-R/M.2012/M.2012-2/LTE/Rel-11/CCSA-TSD-LTE-25466-b30.zip">http://www.ccsa.org.cn/ITU_spec/ITU-R/M.2012/M.2012-2/LTE/Rel-11/CCSA-TSD-LTE-25466-b30.zip</a>
ETSI	ETSI TS 125 466		11.3.0	Jan 13	<a href="http://www.etsi.org/deliver/etsi_ts/125400_125499/125466/11.03.00_60/ts_125466v110300p.pdf">http://www.etsi.org/deliver/etsi_ts/125400_125499/125466/11.03.00_60/ts_125466v110300p.pdf</a>
TTA	TTAT.3G-25.466(R11-11.3.0)		11.3.0	Aug 13	<a href="http://www.tta.or.kr/data/ttasDown.jsp?where=14688&amp;pk_num=TTAT.3G-25.466(R11-11.3.0)">http://www.tta.or.kr/data/ttasDown.jsp?where=14688&amp;pk_num=TTAT.3G-25.466(R11-11.3.0)</a>
TTC	Not applicable				
<b>Release 12</b>					
ARIB	Not applicable				
ATIS	ATIS.3GPP.25.466V1210-2015		12.1.0	May 15	<a href="https://www.atis.org/docstore/default.aspx">https://www.atis.org/docstore/default.aspx</a>
CCSA	CCSA-TSD-LTE-25.466		12.1.0	Apr 15	<a href="http://www.ccsa.org.cn/ITU_spec/ITU-R/M.2012/M.2012-2/LTE/Rel-12/CCSA-TSD-LTE-25466-c10.zip">http://www.ccsa.org.cn/ITU_spec/ITU-R/M.2012/M.2012-2/LTE/Rel-12/CCSA-TSD-LTE-25466-c10.zip</a>
ETSI	ETSI TS 125 466		12.1.0	Sep 14	<a href="http://www.etsi.org/deliver/etsi_ts/125400_125499/125466/12.01.00_60/ts_125466v120100p.pdf">http://www.etsi.org/deliver/etsi_ts/125400_125499/125466/12.01.00_60/ts_125466v120100p.pdf</a>
TTA	TTAT.3G-25.466(R12-12.1.0)		12.1.0	Apr 15	<a href="http://www.tta.or.kr/data/ttasDown.jsp?where=14688&amp;pk_num=TTAT.3G-25.466(R12-12.1.0)">http://www.tta.or.kr/data/ttasDown.jsp?where=14688&amp;pk_num=TTAT.3G-25.466(R12-12.1.0)</a>
TTC	Not applicable				

### 1.2.1.5 Radio-frequency aspects

#### 1.2.1.5.1 TS 36.101

#### Evolved Universal Terrestrial Radio Access (E-UTRA); User Equipment (UE) radio transmission and reception

This document establishes the minimum RF characteristics and minimum performance requirements for E-UTRA User Equipment (UE).

SDO (2)	Document No.	Version	Issued date	Location (1)
<b>Release 10</b>				
ARIB	ARIB STD-T104-36.101		10.17.0 Mar 15	<a href="http://www.arib.or.jp/english/html/overview/doc/STD-T104v2_70/2_T104/ARIB-STD-T104/Rel10/36/A36101-ah0.pdf">http://www.arib.or.jp/english/html/overview/doc/STD-T104v2_70/2_T104/ARIB-STD-T104/Rel10/36/A36101-ah0.pdf</a>
ATIS	ATIS.3GPP.36.101V10170-2015		10.17.0 May 15	<a href="https://www.atis.org/docstore/default.aspx">https://www.atis.org/docstore/default.aspx</a>
CCSA	CCSA-TSD-LTE-36.101		10.17.0 Apr 15	<a href="http://www.ccsa.org.cn/ITU_spec/ITU-R/M.2012/M.2012-2/LTE/Rel-10/CCSA-TSD-LTE-36101-ag0.zip">http://www.ccsa.org.cn/ITU_spec/ITU-R/M.2012/M.2012-2/LTE/Rel-10/CCSA-TSD-LTE-36101-ag0.zip</a>
ETSI	ETSI TS 136 101		10.17.0 Apr 15	<a href="http://www.etsi.org/deliver/etsi_ts/136100_136199/136101/10.17.00_60/ts_136101v101700p.pdf">http://www.etsi.org/deliver/etsi_ts/136100_136199/136101/10.17.00_60/ts_136101v101700p.pdf</a>
TTC	Not applicable			
<b>Release 11</b>				
ARIB	ARIB STD-T104-36.101		11.11.0 Mar 15	<a href="http://www.arib.or.jp/english/html/overview/doc/STD-T104v2_70/2_T104/ARIB-STD-T104/Rel11/36/A36101-bb0.pdf">http://www.arib.or.jp/english/html/overview/doc/STD-T104v2_70/2_T104/ARIB-STD-T104/Rel11/36/A36101-bb0.pdf</a>
ATIS	ATIS.3GPP.36.101V11120-2015		11.12.0 May 15	<a href="https://www.atis.org/docstore/default.aspx">https://www.atis.org/docstore/default.aspx</a>
CCSA	CCSA-TSD-LTE-36.101		11.11.0 Apr 15	<a href="http://www.ccsa.org.cn/ITU_spec/ITU-R/M.2012/M.2012-2/LTE/Rel-11/CCSA-TSD-LTE-36101-bb0.zip">http://www.ccsa.org.cn/ITU_spec/ITU-R/M.2012/M.2012-2/LTE/Rel-11/CCSA-TSD-LTE-36101-bb0.zip</a>
ETSI	ETSI TS 136 101		11.11.0 Apr 15	<a href="http://www.etsi.org/deliver/etsi_ts/136100_136199/136101/11.11.00_60/ts_136101v111100p.pdf">http://www.etsi.org/deliver/etsi_ts/136100_136199/136101/11.11.00_60/ts_136101v111100p.pdf</a>
TTA	TTAT.3G-36.101(R11-11.4.0)		11.4.0 Aug 13	<a href="http://www.tta.or.kr/data/ttasDown.jsp?where=14688&amp;pk_num=TTAT.3G-36.101(R11-11.4.0)">http://www.tta.or.kr/data/ttasDown.jsp?where=14688&amp;pk_num=TTAT.3G-36.101(R11-11.4.0)</a>
TTC	Not applicable			
<b>Release 12</b>				
ARIB	Not applicable			
ATIS	ATIS.3GPP.36.101V1260-2015		12.6.0 May 15	<a href="https://www.atis.org/docstore/default.aspx">https://www.atis.org/docstore/default.aspx</a>
CCSA	CCSA-TSD-LTE-36.101		12.6.0 Apr 15	<a href="http://www.ccsa.org.cn/ITU_spec/ITU-R/M.2012/M.2012-2/LTE/Rel-12/CCSA-TSD-LTE-36101-c60.zip">http://www.ccsa.org.cn/ITU_spec/ITU-R/M.2012/M.2012-2/LTE/Rel-12/CCSA-TSD-LTE-36101-c60.zip</a>
ETSI	ETSI TS 136 101		12.6.0 Apr 15	<a href="http://www.etsi.org/deliver/etsi_ts/136100_136199/136101/12.06.00_60/ts_136101v120600p.pdf">http://www.etsi.org/deliver/etsi_ts/136100_136199/136101/12.06.00_60/ts_136101v120600p.pdf</a>
TTA	TTAT.3G-36.101(R12-12.6.0)		12.6.0 Apr 15	<a href="http://www.tta.or.kr/data/ttasDown.jsp?where=14688&amp;pk_num=TTAT.3G-36.101(R12-12.6.0)">http://www.tta.or.kr/data/ttasDown.jsp?where=14688&amp;pk_num=TTAT.3G-36.101(R12-12.6.0)</a>
TTC	Not applicable			

#### 1.2.1.5.2 TS 36.104

#### Evolved Universal Terrestrial Radio Access (E-UTRA); Base Station (BS) radio transmission and reception

This document establishes the minimum RF characteristics and minimum performance requirements of E-UTRA Base Station (BS).

SDO (2)	Document No.	Version	Issued date	Location (1)
<b>Release 10</b>				
ARIB	ARIB STD-T104-36.104		10.11.0 Sep 13	<a href="http://www.arib.or.jp/english/html/overview/doc/STD-T104v2_10/2_T104/ARIB-STD-T104/Rel10/36/A36104-ab0.pdf">http://www.arib.or.jp/english/html/overview/doc/STD-T104v2_10/2_T104/ARIB-STD-T104/Rel10/36/A36104-ab0.pdf</a>
ATIS	ATIS.3GPP.36.104V10110-2015		10.11.0 May 15	<a href="https://www.atis.org/docstore/default.aspx">https://www.atis.org/docstore/default.aspx</a>
CCSA	CCSA-TSD-LTE-36.104		10.11.0 Apr 15	<a href="http://www.ccsa.org.cn/ITU_spec/ITU-R/M.2012/M.2012-2/LTE/Rel-10/CCSA-TSD-LTE-36104-ab0.zip">http://www.ccsa.org.cn/ITU_spec/ITU-R/M.2012/M.2012-2/LTE/Rel-10/CCSA-TSD-LTE-36104-ab0.zip</a>
ETSI	ETSI TS 136 104		10.11.0 Jul 13	<a href="http://www.etsi.org/deliver/etsi_ts/136100_136199/136104/10.11.00_60/ts_136104v101100p.pdf">http://www.etsi.org/deliver/etsi_ts/136100_136199/136104/10.11.00_60/ts_136104v101100p.pdf</a>
TTC	Not applicable			
<b>Release 11</b>				
ARIB	ARIB STD-T104-36.104		11.11.0 Mar 15	<a href="http://www.arib.or.jp/english/html/overview/doc/STD-T104v2_70/2_T104/ARIB-STD-T104/Rel11/36/A36104-bb0.pdf">http://www.arib.or.jp/english/html/overview/doc/STD-T104v2_70/2_T104/ARIB-STD-T104/Rel11/36/A36104-bb0.pdf</a>

## 52

ATIS	ATIS.3GPP.36.104V11110-2015	11.11.0	May 15	<a href="https://www.atis.org/docstore/default.aspx">https://www.atis.org/docstore/default.aspx</a>
CCSA	CCSA-TSD-LTE-36.104	11.11.0	Apr 15	<a href="http://www.ccsa.org.cn/ITU_spec/ITU-R/M.2012/M.2012-2/LTE/Rel-11/CCSA-TSD-LTE-36104-bb0.zip">http://www.ccsa.org.cn/ITU_spec/ITU-R/M.2012/M.2012-2/LTE/Rel-11/CCSA-TSD-LTE-36104-bb0.zip</a>
ETSI	ETSI TS 136 104	11.11.0	Jan 15	<a href="http://www.etsi.org/deliver/etsi_ts/136100_136199/136104/11.11.00_60/ts_136104v111100p.pdf">http://www.etsi.org/deliver/etsi_ts/136100_136199/136104/11.11.00_60/ts_136104v111100p.pdf</a>
TTA	TTAT.3G-36.104(R11-11.4.0)	11.4.0	Aug 13	<a href="http://www.tta.or.kr/data/ttasDown.jsp?where=14688&amp;pk_num=TTAT.3G-36.104(R11-11.4.0)">http://www.tta.or.kr/data/ttasDown.jsp?where=14688&amp;pk_num=TTAT.3G-36.104(R11-11.4.0)</a>
TTC	Not applicable			

### Release 12

ARIB	Not applicable			
ATIS	ATIS.3GPP.36.104V1260-2015	12.6.0	May 15	<a href="https://www.atis.org/docstore/default.aspx">https://www.atis.org/docstore/default.aspx</a>
CCSA	CCSA-TSD-LTE-36.104	12.6.0	Apr 15	<a href="http://www.ccsa.org.cn/ITU_spec/ITU-R/M.2012/M.2012-2/LTE/Rel-12/CCSA-TSD-LTE-36104-c60.zip">http://www.ccsa.org.cn/ITU_spec/ITU-R/M.2012/M.2012-2/LTE/Rel-12/CCSA-TSD-LTE-36104-c60.zip</a>
ETSI	ETSI TS 136 104	12.6.0	Feb 15	<a href="http://www.etsi.org/deliver/etsi_ts/136100_136199/136104/12.06.00_60/ts_136104v120600p.pdf">http://www.etsi.org/deliver/etsi_ts/136100_136199/136104/12.06.00_60/ts_136104v120600p.pdf</a>
TTA	TTAT.3G-36.104(R12-12.6.0)	12.6.0	Apr 15	<a href="http://www.tta.or.kr/data/ttasDown.jsp?where=14688&amp;pk_num=TTAT.3G-36.104(R12-12.6.0)">http://www.tta.or.kr/data/ttasDown.jsp?where=14688&amp;pk_num=TTAT.3G-36.104(R12-12.6.0)</a>
TTC	Not applicable			

### 1.2.1.5.3 TS 36.106

#### Evolved Universal Terrestrial Radio Access (E-UTRA); FDD repeater radio transmission and reception

This document establishes the minimum RF characteristics of E-UTRA FDD Repeater.

SDO (2)	Document No.	Version	Issued date	Location (1)
<b>Release 10</b>				
ARIB	Not applicable			
ATIS	ATIS.3GPP.36.106V1070-2013	10.7.0	Jun 13	<a href="https://www.atis.org/docstore/default.aspx">https://www.atis.org/docstore/default.aspx</a>
CCSA	CCSA-TSD-LTE-36.106	10.7.0	Apr 15	<a href="http://www.ccsa.org.cn/ITU_spec/ITU-R/M.2012/M.2012-2/LTE/Rel-10/CCSA-TSD-LTE-36106-a70.zip">http://www.ccsa.org.cn/ITU_spec/ITU-R/M.2012/M.2012-2/LTE/Rel-10/CCSA-TSD-LTE-36106-a70.zip</a>
ETSI	ETSI TS 136 106	10.7.0	Apr 13	<a href="http://www.etsi.org/deliver/etsi_ts/136100_136199/136106/10.07.00_60/ts_136106v100700p.pdf">http://www.etsi.org/deliver/etsi_ts/136100_136199/136106/10.07.00_60/ts_136106v100700p.pdf</a>
TTC	Not applicable			
<b>Release 11</b>				
ARIB	Not applicable			
ATIS	ATIS.3GPP.36.106V1120-2013	11.2.0	Jun 13	<a href="https://www.atis.org/docstore/default.aspx">https://www.atis.org/docstore/default.aspx</a>
CCSA	CCSA-TSD-LTE-36.106	11.2.0	Apr 15	<a href="http://www.ccsa.org.cn/ITU_spec/ITU-R/M.2012/M.2012-2/LTE/Rel-11/CCSA-TSD-LTE-36106-b20.zip">http://www.ccsa.org.cn/ITU_spec/ITU-R/M.2012/M.2012-2/LTE/Rel-11/CCSA-TSD-LTE-36106-b20.zip</a>
ETSI	ETSI TS 136 106	11.2.0	Apr 13	<a href="http://www.etsi.org/deliver/etsi_ts/136100_136199/136106/11.02.00_60/ts_136106v110200p.pdf">http://www.etsi.org/deliver/etsi_ts/136100_136199/136106/11.02.00_60/ts_136106v110200p.pdf</a>
TTA	TTAT.3G-36.106(R11-11.2.0)	11.2.0	Aug 13	<a href="http://www.tta.or.kr/data/ttasDown.jsp?where=14688&amp;pk_num=TTAT.3G-36.106(R11-11.2.0)">http://www.tta.or.kr/data/ttasDown.jsp?where=14688&amp;pk_num=TTAT.3G-36.106(R11-11.2.0)</a>
TTC	Not applicable			
<b>Release 12</b>				
ARIB	Not applicable			
ATIS	ATIS.3GPP.36.106V1210-2015	12.1.0	May 15	<a href="https://www.atis.org/docstore/default.aspx">https://www.atis.org/docstore/default.aspx</a>
CCSA	CCSA-TSD-LTE-36.106	12.1.0	Apr 15	<a href="http://www.ccsa.org.cn/ITU_spec/ITU-R/M.2012/M.2012-2/LTE/Rel-12/CCSA-TSD-LTE-36106-c10.zip">http://www.ccsa.org.cn/ITU_spec/ITU-R/M.2012/M.2012-2/LTE/Rel-12/CCSA-TSD-LTE-36106-c10.zip</a>
ETSI	ETSI TS 136 106	12.1.0	Feb 15	<a href="http://www.etsi.org/deliver/etsi_ts/136100_136199/136106/12.01.00_60/ts_136106v120100p.pdf">http://www.etsi.org/deliver/etsi_ts/136100_136199/136106/12.01.00_60/ts_136106v120100p.pdf</a>
TTA	TTAT.3G-36.106(R12-12.1.0)	12.1.0	Apr 15	<a href="http://www.tta.or.kr/data/ttasDown.jsp?where=14688&amp;pk_num=TTAT.3G-36.106(R12-12.1.0)">http://www.tta.or.kr/data/ttasDown.jsp?where=14688&amp;pk_num=TTAT.3G-36.106(R12-12.1.0)</a>
TTC	Not applicable			

**1.2.1.5.4 TS 36.111****Location Measurement Unit (LMU) performance specification; Network based positioning systems in Evolved Universal Terrestrial Radio Access Network (E-UTRAN)**

This document establishes the Location Measurement Unit (LMU) minimum UTDOA positioning requirement for the FDD and TDD mode of E-UTRAN.

SDO (2)	Document No.	Version	Issued date	Location (1)
---------	--------------	---------	-------------	--------------

**Release 10 (not applicable – this specification added beginning with Release 11)**

**Release 11**

ARIB	ARIB STD-T104-36.111		11.4.0	Mar 15	<a href="http://www.arib.or.jp/english/html/overview/doc/STD-T104v2_70/2_T104/ARIB-STD-T104/Rel11/36/A36111-b40.pdf">http://www.arib.or.jp/english/html/overview/doc/STD-T104v2_70/2_T104/ARIB-STD-T104/Rel11/36/A36111-b40.pdf</a>
ATIS	ATIS.3GPP.36.111V1140-2015		11.4.0	May 15	<a href="https://www.atis.org/docstore/default.aspx">https://www.atis.org/docstore/default.aspx</a>
CCSA	CCSA-TSD-LTE-36.111		11.4.0	Apr 15	<a href="http://www.ccsa.org.cn/ITU_spec/ITU-R/M.2012/M.2012-2/LTE/Rel-11/CCSA-TSD-LTE-36111-b40.zip">http://www.ccsa.org.cn/ITU_spec/ITU-R/M.2012/M.2012-2/LTE/Rel-11/CCSA-TSD-LTE-36111-b40.zip</a>
ETSI	ETSI TS 136 111		11.4.0	Oct 14	<a href="http://www.etsi.org/deliver/etsi_ts/136100_136199/136111/11.04.00_60/ts_136111v110400p.pdf">http://www.etsi.org/deliver/etsi_ts/136100_136199/136111/11.04.00_60/ts_136111v110400p.pdf</a>
TTA	TTAT.3G-36.111(R11-11.4.0)		11.4.0	Apr 15	<a href="http://www.tta.or.kr/data/ttasDown.jsp?where=14688&amp;pk_num=TTAT.3G-36.111(R11-11.4.0)">http://www.tta.or.kr/data/ttasDown.jsp?where=14688&amp;pk_num=TTAT.3G-36.111(R11-11.4.0)</a>
TTC	Not applicable				

**Release 12**

ARIB	Not applicable				
ATIS	ATIS.3GPP.36.111V1200-2015		12.0.0	May 15	<a href="https://www.atis.org/docstore/default.aspx">https://www.atis.org/docstore/default.aspx</a>
CCSA	CCSA-TSD-LTE-36.111		12.0.0	Apr 15	<a href="http://www.ccsa.org.cn/ITU_spec/ITU-R/M.2012/M.2012-2/LTE/Rel-12/CCSA-TSD-LTE-36111-c00.zip">http://www.ccsa.org.cn/ITU_spec/ITU-R/M.2012/M.2012-2/LTE/Rel-12/CCSA-TSD-LTE-36111-c00.zip</a>
ETSI	ETSI TS 136 111		12.0.0	Oct 14	<a href="http://www.etsi.org/deliver/etsi_ts/136100_136199/136111/12.00.00_60/ts_136111v120000p.pdf">http://www.etsi.org/deliver/etsi_ts/136100_136199/136111/12.00.00_60/ts_136111v120000p.pdf</a>
TTA	TTAT.3G-36.111(R12-12.0.0)		12.0.0	Apr 15	<a href="http://www.tta.or.kr/data/ttasDown.jsp?where=14688&amp;pk_num=TTAT.3G-36.111(R12-12.0.0)">http://www.tta.or.kr/data/ttasDown.jsp?where=14688&amp;pk_num=TTAT.3G-36.111(R12-12.0.0)</a>
TTC	Not applicable				

**1.2.1.5.5 TS 36.112****Location Measurement Unit (LMU) conformance specification; Network based positioning systems in Evolved Universal Terrestrial Radio Access Network (E-UTRAN)**

This document establishes the conformance requirements for E-UTRAN Location Measurement Units (LMU) operating in the FDD or TDD mode.

SDO (2)	Document No.	Version	Issued date	Location (1)
---------	--------------	---------	-------------	--------------

**Release 10 (not applicable – this specification added beginning with Release 11)**

**Release 11**

ARIB	ARIB STD-T104-36.112		11.1.0	Mar 15	<a href="http://www.arib.or.jp/english/html/overview/doc/STD-T104v2_70/2_T104/ARIB-STD-T104/Rel11/36/A36112-b10.pdf">http://www.arib.or.jp/english/html/overview/doc/STD-T104v2_70/2_T104/ARIB-STD-T104/Rel11/36/A36112-b10.pdf</a>
ATIS	ATIS.3GPP.36.112V1110-2015		11.1.0	May 15	<a href="https://www.atis.org/docstore/default.aspx">https://www.atis.org/docstore/default.aspx</a>
CCSA	CCSA-TSD-LTE-36.112		11.1.0	Apr 15	<a href="http://www.ccsa.org.cn/ITU_spec/ITU-R/M.2012/M.2012-2/LTE/Rel-11/CCSA-TSD-LTE-36112-b10.zip">http://www.ccsa.org.cn/ITU_spec/ITU-R/M.2012/M.2012-2/LTE/Rel-11/CCSA-TSD-LTE-36112-b10.zip</a>
ETSI	ETSI TS 136 112		11.1.0	Feb 15	<a href="http://www.etsi.org/deliver/etsi_ts/136100_136199/136112/11.01.00_60/ts_136112v110100p.pdf">http://www.etsi.org/deliver/etsi_ts/136100_136199/136112/11.01.00_60/ts_136112v110100p.pdf</a>
TTA	TTAT.3G-36.112(R11-11.1.0)		11.1.0	Apr 15	<a href="http://www.tta.or.kr/data/ttasDown.jsp?where=14688&amp;pk_num=TTAT.3G-36.112(R11-11.1.0)">http://www.tta.or.kr/data/ttasDown.jsp?where=14688&amp;pk_num=TTAT.3G-36.112(R11-11.1.0)</a>
TTC	Not applicable				

**Release 12**

ARIB	Not applicable				
ATIS	ATIS.3GPP.36.111V1210-2015	12.1.0	May 15	<a href="https://www.atis.org/docstore/default.aspx">https://www.atis.org/docstore/default.aspx</a>	
CCSA	CCSA-TSD-LTE-36.112	12.1.0	Apr 15	<a href="http://www.ccsa.org.cn/ITU_spec/ITU-R/M.2012/M.2012-2/LTE/Rel-12/CCSA-TSD-LTE-36112-c10.zip">http://www.ccsa.org.cn/ITU_spec/ITU-R/M.2012/M.2012-2/LTE/Rel-12/CCSA-TSD-LTE-36112-c10.zip</a>	
ETSI	ETSI TS 136 112	12.1.0	Feb 15	<a href="http://www.etsi.org/deliver/etsi_ts/136100_136199/136112/12.01.00_60/ts_136112v120100p.pdf">http://www.etsi.org/deliver/etsi_ts/136100_136199/136112/12.01.00_60/ts_136112v120100p.pdf</a>	
TTA	TTAT.3G-36.112(R12-12.1.0)	12.1.0	Apr 15	<a href="http://www.tta.or.kr/data/ttasDown.jsp?where=14688&amp;pk_num=TTAT.3G-36.112(R12-12.1.0)">http://www.tta.or.kr/data/ttasDown.jsp?where=14688&amp;pk_num=TTAT.3G-36.112(R12-12.1.0)</a>	
TTC	Not applicable				

**1.2.1.5.6 TS 36.113****Evolved Universal Terrestrial Radio Access (E-UTRA); Base Station (BS) and repeater ElectroMagnetic Compatibility (EMC)**

This document covers the assessment of E-UTRA base stations, repeaters and associated ancillary equipment in respect of Electromagnetic Compatibility (EMC). This document specifies the applicable test conditions, performance assessment and performance criteria for E-UTRA base stations, repeaters and associated ancillary equipment in one of the following categories: (i) base stations of E-UTRA meeting the requirements of TS 36.104, with conformance demonstrated by compliance to TS 36.141; (ii) repeaters of FDD E-UTRA meeting the requirements of TS 36.106, with conformance demonstrated by compliance to TS 36.143. The environment classification used in this document refers to the environment classification used in IEC 61000-6-1 and IEC 61000-6-3. The EMC requirements have been selected to ensure an adequate level of compatibility for apparatus at residential, commercial and light industrial environments. The levels, however, do not cover extreme cases which may occur in any location but with low probability of occurrence.

SDO (2)	Document No.	Version	Issued date	Location (1)
<b>Release 10</b>				
ARIB	ARIB STD-T104-36.113		10.5.0 Sep 12	<a href="http://www.arib.or.jp/english/html/overview/doc/STD-T104v1_30/2_T104/ARIB-STD-T104/Rel10/36/A36113-a50.pdf">http://www.arib.or.jp/english/html/overview/doc/STD-T104v1_30/2_T104/ARIB-STD-T104/Rel10/36/A36113-a50.pdf</a>
ATIS	ATIS.3GPP.36.113V1050-2013		10.5.0 Jun 13	<a href="https://www.atis.org/docstore/default.aspx">https://www.atis.org/docstore/default.aspx</a>
CCSA	CCSA-TSD-LTE-36.113		10.5.0 Apr 15	<a href="http://www.ccsa.org.cn/ITU_spec/ITU-R/M.2012/M.2012-2/LTE/Rel-10/CCSA-TSD-LTE-36113-a50.zip">http://www.ccsa.org.cn/ITU_spec/ITU-R/M.2012/M.2012-2/LTE/Rel-10/CCSA-TSD-LTE-36113-a50.zip</a>
ETSI	ETSI TS 136 113		10.5.0 Jul 12	<a href="http://www.etsi.org/deliver/etsi_ts/136100_136199/136113/10.05.00_60/ts_136113v100500p.pdf">http://www.etsi.org/deliver/etsi_ts/136100_136199/136113/10.05.00_60/ts_136113v100500p.pdf</a>
TTC	Not applicable			
<b>Release 11</b>				
ARIB	ARIB STD-T104-36.113		11.3.0 Mar 15	<a href="http://www.arib.or.jp/english/html/overview/doc/STD-T104v2_70/2_T104/ARIB-STD-T104/Rel11/36/A36113-b30.pdf">http://www.arib.or.jp/english/html/overview/doc/STD-T104v2_70/2_T104/ARIB-STD-T104/Rel11/36/A36113-b30.pdf</a>
ATIS	ATIS.3GPP.36.113V1130-2015		11.3.0 May 15	<a href="https://www.atis.org/docstore/default.aspx">https://www.atis.org/docstore/default.aspx</a>
CCSA	CCSA-TSD-LTE-36.113		11.3.0 Apr 15	<a href="http://www.ccsa.org.cn/ITU_spec/ITU-R/M.2012/M.2012-2/LTE/Rel-11/CCSA-TSD-LTE-36113-b30.zip">http://www.ccsa.org.cn/ITU_spec/ITU-R/M.2012/M.2012-2/LTE/Rel-11/CCSA-TSD-LTE-36113-b30.zip</a>
ETSI	ETSI TS 136 113		11.3.0 Feb 15	<a href="http://www.etsi.org/deliver/etsi_ts/136100_136199/136113/11.03.00_60/ts_136113v110300p.pdf">http://www.etsi.org/deliver/etsi_ts/136100_136199/136113/11.03.00_60/ts_136113v110300p.pdf</a>
TTA	TTAT.3G-36.113(R11-11.2.0)		11.2.0 Aug 13	<a href="http://www.tta.or.kr/data/ttasDown.jsp?where=14688&amp;pk_num=TTAT.3G-36.113(R11-11.2.0)">http://www.tta.or.kr/data/ttasDown.jsp?where=14688&amp;pk_num=TTAT.3G-36.113(R11-11.2.0)</a>
TTC	Not applicable			
<b>Release 12</b>				
ARIB	Not applicable			
ATIS	ATIS.3GPP.36.113V1230-2015		12.3.0 May 15	<a href="https://www.atis.org/docstore/default.aspx">https://www.atis.org/docstore/default.aspx</a>
CCSA	CCSA-TSD-LTE-36.113		12.3.0 Apr 15	<a href="http://www.ccsa.org.cn/ITU_spec/ITU-R/M.2012/M.2012-2/LTE/Rel-12/CCSA-TSD-LTE-36113-c30.zip">http://www.ccsa.org.cn/ITU_spec/ITU-R/M.2012/M.2012-2/LTE/Rel-12/CCSA-TSD-LTE-36113-c30.zip</a>
ETSI	ETSI TS 136 113		12.3.0 Feb 15	<a href="http://www.etsi.org/deliver/etsi_ts/136100_136199/136113/12.03.00_60/ts_136113v120300p.pdf">http://www.etsi.org/deliver/etsi_ts/136100_136199/136113/12.03.00_60/ts_136113v120300p.pdf</a>
TTA	TTAT.3G-36.113(R12-12.3.0)		12.3.0 Apr 15	<a href="http://www.tta.or.kr/data/ttasDown.jsp?where=14688&amp;pk_num=TTAT.3G-36.113(R12-12.3.0)">http://www.tta.or.kr/data/ttasDown.jsp?where=14688&amp;pk_num=TTAT.3G-36.113(R12-12.3.0)</a>
TTC	Not applicable			



**1.2.1.5.7 TS 36.116****Evolved Universal Terrestrial Radio Access (E-UTRA); Relay radio transmission and reception**

This document establishes the minimum RF characteristics and minimum performance requirements of E-UTRA Relay.

SDO (2)	Document No.	Version	Issued date	Location (1)
<b>Release 10 (not applicable – this specification added beginning with Release 11)</b>				
<b>Release 11</b>				
ARIB	Not applicable			
ATIS	ATIS.3GPP.36.116V1130-2015	11.3.0	May 15	<a href="https://www.atis.org/docstore/default.aspx">https://www.atis.org/docstore/default.aspx</a>
CCSA	CCSA-TSD-LTE-36.116	11.3.0	Apr 15	<a href="http://www.ccsa.org.cn/ITU_spec/ITU-R/M.2012/M.2012-2/LTE/Rel-11/CCSA-TSD-LTE-36116-b30.zip">http://www.ccsa.org.cn/ITU_spec/ITU-R/M.2012/M.2012-2/LTE/Rel-11/CCSA-TSD-LTE-36116-b30.zip</a>
ETSI	ETSI TS 136 116	11.3.0	Jul 13	<a href="http://www.etsi.org/deliver/etsi_ts/136100_136199/136116/11.03.00_60/ts_136116v110300p.pdf">http://www.etsi.org/deliver/etsi_ts/136100_136199/136116/11.03.00_60/ts_136116v110300p.pdf</a>
TTA	TTAT.3G-36.116(R11-11.2.0)	11.2.0	Aug 13	<a href="http://www.tta.or.kr/data/ttasDown.jsp?where=14688&amp;pk_num=TTAT.3G-36.116(R11-11.2.0)">http://www.tta.or.kr/data/ttasDown.jsp?where=14688&amp;pk_num=TTAT.3G-36.116(R11-11.2.0)</a>
TTC	Not applicable			
<b>Release 12</b>				
ARIB	Not applicable			
ATIS	ATIS.3GPP.36.116V1200-2015	12.0.0	May 15	<a href="https://www.atis.org/docstore/default.aspx">https://www.atis.org/docstore/default.aspx</a>
CCSA	CCSA-TSD-LTE-36.116	12.0.0	Apr 15	<a href="http://www.ccsa.org.cn/ITU_spec/ITU-R/M.2012/M.2012-2/LTE/Rel-12/CCSA-TSD-LTE-36116-c00.zip">http://www.ccsa.org.cn/ITU_spec/ITU-R/M.2012/M.2012-2/LTE/Rel-12/CCSA-TSD-LTE-36116-c00.zip</a>
ETSI	ETSI TS 136 116	12.0.0	Oct 14	<a href="http://www.etsi.org/deliver/etsi_ts/136100_136199/136116/12.00.00_60/ts_136116v120000p.pdf">http://www.etsi.org/deliver/etsi_ts/136100_136199/136116/12.00.00_60/ts_136116v120000p.pdf</a>
TTA	TTAT.3G-36.116(R12-12.0.0)	12.0.0	Apr 15	<a href="http://www.tta.or.kr/data/ttasDown.jsp?where=14688&amp;pk_num=TTAT.3G-36.116(R12-12.0.0)">http://www.tta.or.kr/data/ttasDown.jsp?where=14688&amp;pk_num=TTAT.3G-36.116(R12-12.0.0)</a>
TTC	Not applicable			

**1.2.1.5.8 TS 36.117****Evolved Universal Terrestrial Radio Access (E-UTRA); Relay conformance testing**

This document specifies the Radio Frequency (RF) test methods and conformance requirements for E-UTRA Relay. These have been derived from, and are consistent with the E-UTRA Relay specifications defined in TS 36.116.

SDO (2)	Document No.	Version	Issued date	Location (1)
<b>Release 10 (not applicable – this specification added beginning with Release 11)</b>				
<b>Release 11</b>				
ARIB	Not applicable			
ATIS	ATIS.3GPP.36.117V1110-2015	11.1.0	May 15	<a href="https://www.atis.org/docstore/default.aspx">https://www.atis.org/docstore/default.aspx</a>
CCSA	CCSA-TSD-LTE-36.117	11.1.0	Apr 15	<a href="http://www.ccsa.org.cn/ITU_spec/ITU-R/M.2012/M.2012-2/LTE/Rel-11/CCSA-TSD-LTE-36117-b10.zip">http://www.ccsa.org.cn/ITU_spec/ITU-R/M.2012/M.2012-2/LTE/Rel-11/CCSA-TSD-LTE-36117-b10.zip</a>
ETSI	ETSI TS 136 117	11.1.0	Oct 13	<a href="http://www.etsi.org/deliver/etsi_ts/136100_136199/136117/11.01.00_60/ts_136117v110100p.pdf">http://www.etsi.org/deliver/etsi_ts/136100_136199/136117/11.01.00_60/ts_136117v110100p.pdf</a>
TTA	TTAT.3G-36.117(R11-11.1.0)	11.1.0	Apr 15	<a href="http://www.tta.or.kr/data/ttasDown.jsp?where=14688&amp;pk_num=TTAT.3G-36.117(R11-11.1.0)">http://www.tta.or.kr/data/ttasDown.jsp?where=14688&amp;pk_num=TTAT.3G-36.117(R11-11.1.0)</a>
TTC	Not applicable			
<b>Release 12</b>				
ARIB	Not applicable			
ATIS	ATIS.3GPP.36.117V1200-2015	12.0.0	May 15	<a href="https://www.atis.org/docstore/default.aspx">https://www.atis.org/docstore/default.aspx</a>
CCSA	CCSA-TSD-LTE-36.117	12.0.0	Apr 15	<a href="http://www.ccsa.org.cn/ITU_spec/ITU-R/M.2012/M.2012-2/LTE/Rel-12/CCSA-TSD-LTE-36117-c00.zip">http://www.ccsa.org.cn/ITU_spec/ITU-R/M.2012/M.2012-2/LTE/Rel-12/CCSA-TSD-LTE-36117-c00.zip</a>
ETSI	ETSI TS 136 117	12.0.0	Oct 14	<a href="http://www.etsi.org/deliver/etsi_ts/136100_136199/136117/12.00.00_60/ts_136117v120000p.pdf">http://www.etsi.org/deliver/etsi_ts/136100_136199/136117/12.00.00_60/ts_136117v120000p.pdf</a>

TTA	TTAT.3G-36.117(R12-12.0.0)	12.0.0	Apr 15	<a href="http://www.tta.or.kr/data/ttasDown.jsp?where=14688&amp;pk_num=TTAT.3G-36.117(R12-12.0.0)">http://www.tta.or.kr/data/ttasDown.jsp?where=14688&amp;pk_num=TTAT.3G-36.117(R12-12.0.0)</a>
TTC	Not applicable			

### 1.2.1.5.9 TS 36.124

#### Evolved Universal Terrestrial Radio Access (E-UTRA); Electromagnetic compatibility (EMC) requirements for mobile terminals and ancillary equipment

This document establishes the essential EMC requirements for “3<sup>rd</sup> generation” digital cellular mobile terminal equipment and ancillary accessories in combination with a 3GPP E-UTRA user equipment (UE). This document specifies the applicable EMC tests, the methods of measurement, the frequency range, the limits and the minimum performance criteria for all types of E-UTRA UEs and their accessories. Requirements for the radiated emission from the enclosure port of integral antenna equipment and ancillaries have been included. The immunity requirements have been selected to ensure an adequate level of compatibility for apparatus in residential, commercial, light industrial and vehicular environments. The levels however, do not cover extreme cases, which may occur in any location but with low probability of occurrence. Compliance of radio equipment to the requirements of this document does not signify compliance to any requirement related to the use of the equipment (i.e. licensing requirements). Compliance to the requirements of this document does not signify compliance to any safety requirement. However, any temporary or permanent unsafe condition caused by EMC is considered as non-compliance.

SDO (2)	Document No.	Version	Issued date	Location (1)
<b>Release 10</b>				
ARIB	ARIB STD-T104-36.124		10.3.0 Dec 11	<a href="http://www.arib.or.jp/english/html/overview/doc/STD-T104v1_10/2_T104/ARIB-STD-T104/Rel10/36/A36124-a30.pdf">http://www.arib.or.jp/english/html/overview/doc/STD-T104v1_10/2_T104/ARIB-STD-T104/Rel10/36/A36124-a30.pdf</a>
ATIS	ATIS.3GPP.36.124V1030-2013		10.3.0 Jun 13	<a href="https://www.atis.org/docstore/default.aspx">https://www.atis.org/docstore/default.aspx</a>
CCSA	CCSA-TSD-LTE-36.124		10.3.0 Apr 15	<a href="http://www.ccsa.org.cn/ITU_spec/ITU-R/M.2012/M.2012-2/LTE/Rel-10/CCSA-TSD-LTE-36124-a30.zip">http://www.ccsa.org.cn/ITU_spec/ITU-R/M.2012/M.2012-2/LTE/Rel-10/CCSA-TSD-LTE-36124-a30.zip</a>
ETSI	ETSI TS 136 124		10.3.0 Nov 11	<a href="http://www.etsi.org/deliver/etsi_ts/136100_136199/136124/10.03.00_60/ts_136124v100300p.pdf">http://www.etsi.org/deliver/etsi_ts/136100_136199/136124/10.03.00_60/ts_136124v100300p.pdf</a>
TTC	Not applicable			
<b>Release 11</b>				
ARIB	ARIB STD-T104-36.124		11.2.0 Jul 13	<a href="http://www.arib.or.jp/english/html/overview/doc/STD-T104v2_00/2_T104/ARIB-STD-T104/Rel11/36/A36124-b20.pdf">http://www.arib.or.jp/english/html/overview/doc/STD-T104v2_00/2_T104/ARIB-STD-T104/Rel11/36/A36124-b20.pdf</a>
ATIS	ATIS.3GPP.36.124V1120-2013		11.2.0 Jun 13	<a href="https://www.atis.org/docstore/default.aspx">https://www.atis.org/docstore/default.aspx</a>
CCSA	CCSA-TSD-LTE-36.124		11.2.0 Apr 15	<a href="http://www.ccsa.org.cn/ITU_spec/ITU-R/M.2012/M.2012-2/LTE/Rel-11/CCSA-TSD-LTE-36124-b20.zip">http://www.ccsa.org.cn/ITU_spec/ITU-R/M.2012/M.2012-2/LTE/Rel-11/CCSA-TSD-LTE-36124-b20.zip</a>
ETSI	ETSI TS 136 124		11.2.0 Feb 13	<a href="http://www.etsi.org/deliver/etsi_ts/136100_136199/136124/11.02.00_60/ts_136124v110200p.pdf">http://www.etsi.org/deliver/etsi_ts/136100_136199/136124/11.02.00_60/ts_136124v110200p.pdf</a>
TTA	TTAT.3G-36.124(R11-11.2.0)		11.2.0 Aug 13	<a href="http://www.tta.or.kr/data/ttasDown.jsp?where=14688&amp;pk_num=TTAT.3G-36.124(R11-11.2.0)">http://www.tta.or.kr/data/ttasDown.jsp?where=14688&amp;pk_num=TTAT.3G-36.124(R11-11.2.0)</a>
TTC	Not applicable			
<b>Release 12</b>				
ARIB	Not applicable			
ATIS	ATIS.3GPP.36.124V1210-2015		12.1.0 May 15	<a href="https://www.atis.org/docstore/default.aspx">https://www.atis.org/docstore/default.aspx</a>
CCSA	CCSA-TSD-LTE-36.124		12.1.0 Apr 15	<a href="http://www.ccsa.org.cn/ITU_spec/ITU-R/M.2012/M.2012-2/LTE/Rel-12/CCSA-TSD-LTE-36124-c10.zip">http://www.ccsa.org.cn/ITU_spec/ITU-R/M.2012/M.2012-2/LTE/Rel-12/CCSA-TSD-LTE-36124-c10.zip</a>
ETSI	ETSI TS 136 124		12.1.0 Oct 14	<a href="http://www.etsi.org/deliver/etsi_ts/136100_136199/136124/12.01.00_60/ts_136124v120100p.pdf">http://www.etsi.org/deliver/etsi_ts/136100_136199/136124/12.01.00_60/ts_136124v120100p.pdf</a>
TTA	TTAT.3G-36.124(R12-12.1.0)		12.1.0 Apr 15	<a href="http://www.tta.or.kr/data/ttasDown.jsp?where=14688&amp;pk_num=TTAT.3G-36.124(R12-12.1.0)">http://www.tta.or.kr/data/ttasDown.jsp?where=14688&amp;pk_num=TTAT.3G-36.124(R12-12.1.0)</a>
TTC	Not applicable			

**1.2.1.5.10 TS 36.133****Evolved Universal Terrestrial Radio Access (E-UTRA); Requirements for support of radio resource management**

This document specifies requirements for support of Radio Resource Management for the FDD and TDD modes of E-UTRA. These requirements include requirements on measurements in UTRAN and the UE as well as requirements on node dynamical behaviour and interaction, in terms of delay and response characteristics.

SDO (2)	Document No.	Version	Issued date	Location (1)
<b>Release 10</b>				
ARIB	ARIB STD-T104-	36.133	10.17.0 Mar 15	<a href="http://www.arib.or.jp/english/html/overview/doc/STD-T104v2_70/2_T104/ARIB-STD-T104/Rel10/36/A36133-ah0.pdf">http://www.arib.or.jp/english/html/overview/doc/STD-T104v2_70/2_T104/ARIB-STD-T104/Rel10/36/A36133-ah0.pdf</a>
ATIS	ATIS.3GPP.36.133V10170-	2015	10.17.0 May 15	<a href="https://www.atis.org/docstore/default.aspx">https://www.atis.org/docstore/default.aspx</a>
CCSA	CCSA-TSD-LTE-36.133		10.17.0 Apr 15	<a href="http://www.ccsa.org.cn/ITU_spec/ITU-R/M.2012/M.2012-2/LTE/Rel-10/CCSA-TSD-LTE-36133-ah0.zip">http://www.ccsa.org.cn/ITU_spec/ITU-R/M.2012/M.2012-2/LTE/Rel-10/CCSA-TSD-LTE-36133-ah0.zip</a>
ETSI	ETSI TS 136 133		10.17.0 Apr 15	<a href="http://www.etsi.org/deliver/etsi_ts/136100_136199/136133/10.17.00_60/ts_136133v101700p.pdf">http://www.etsi.org/deliver/etsi_ts/136100_136199/136133/10.17.00_60/ts_136133v101700p.pdf</a>
TTC	Not applicable			
<b>Release 11</b>				
ARIB	ARIB STD-T104-	36.133	11.11.0 Mar 15	<a href="http://www.arib.or.jp/english/html/overview/doc/STD-T104v2_70/2_T104/ARIB-STD-T104/Rel11/36/A36133-bb0.pdf">http://www.arib.or.jp/english/html/overview/doc/STD-T104v2_70/2_T104/ARIB-STD-T104/Rel11/36/A36133-bb0.pdf</a>
ATIS	ATIS.3GPP.36.133V11110-	2015	11.11.0 May 15	<a href="https://www.atis.org/docstore/default.aspx">https://www.atis.org/docstore/default.aspx</a>
CCSA	CCSA-TSD-LTE-36.133		11.11.0 Apr 15	<a href="http://www.ccsa.org.cn/ITU_spec/ITU-R/M.2012/M.2012-2/LTE/Rel-11/CCSA-TSD-LTE-36133-bb0.zip">http://www.ccsa.org.cn/ITU_spec/ITU-R/M.2012/M.2012-2/LTE/Rel-11/CCSA-TSD-LTE-36133-bb0.zip</a>
ETSI	ETSI TS 136 133		11.11.0 Apr 15	<a href="http://www.etsi.org/deliver/etsi_ts/136100_136199/136133/11.11.00_60/ts_136133v111100p.pdf">http://www.etsi.org/deliver/etsi_ts/136100_136199/136133/11.11.00_60/ts_136133v111100p.pdf</a>
TTA	TTAT.3G-36.133(R11-11.4.0)		11.4.0 Aug 13	<a href="http://www.tta.or.kr/data/ttasDown.jsp?where=14688&amp;pk_num=TTAT.3G-36.133(R11-11.4.0)">http://www.tta.or.kr/data/ttasDown.jsp?where=14688&amp;pk_num=TTAT.3G-36.133(R11-11.4.0)</a>
TTC	Not applicable			
<b>Release 12</b>				
ARIB	Not applicable			
ATIS	ATIS.3GPP.36.133V1260-	2015	12.6.0 May 15	<a href="https://www.atis.org/docstore/default.aspx">https://www.atis.org/docstore/default.aspx</a>
CCSA	CCSA-TSD-LTE-36.133		12.6.0 Apr 15	<a href="http://www.ccsa.org.cn/ITU_spec/ITU-R/M.2012/M.2012-2/LTE/Rel-12/CCSA-TSD-LTE-36133-c60.zip">http://www.ccsa.org.cn/ITU_spec/ITU-R/M.2012/M.2012-2/LTE/Rel-12/CCSA-TSD-LTE-36133-c60.zip</a>
ETSI	ETSI TS 136 133		12.6.0 Apr 15	<a href="http://www.etsi.org/deliver/etsi_ts/136100_136199/136133/12.06.00_60/ts_136133v120600p.pdf">http://www.etsi.org/deliver/etsi_ts/136100_136199/136133/12.06.00_60/ts_136133v120600p.pdf</a>
TTA	TTAT.3G-36.133(R12-12.6.0)		12.6.0 Apr 15	<a href="http://www.tta.or.kr/data/ttasDown.jsp?where=14688&amp;pk_num=TTAT.3G-36.133(R12-12.6.0)">http://www.tta.or.kr/data/ttasDown.jsp?where=14688&amp;pk_num=TTAT.3G-36.133(R12-12.6.0)</a>
TTC	Not applicable			

**1.2.1.5.11 TS 36.141****Evolved Universal Terrestrial Radio Access (E-UTRA); Base Station (BS) conformance testing**

This document specifies the Radio Frequency (RF) test methods and conformance requirements for E-UTRA Base Stations (BS) operating either in the FDD mode (used in paired bands) or the TDD mode (used in unpaired bands). These have been derived from, and are consistent with the E-UTRA Base Station (BS) specifications defined in TS 36 104.

SDO (2)	Document No.	Version	Issued date	Location (1)
<b>Release 10</b>				
ARIB	ARIB STD-T104-	36.141	10.12.0 Dec 13	<a href="http://www.arib.or.jp/english/html/overview/doc/STD-T104v2_20/2_T104/ARIB-STD-T104/Rel10/36/A36133-ac0.pdf">http://www.arib.or.jp/english/html/overview/doc/STD-T104v2_20/2_T104/ARIB-STD-T104/Rel10/36/A36133-ac0.pdf</a>
ATIS	ATIS.3GPP.36.141V10120-	2015	10.12.0 May 15	<a href="https://www.atis.org/docstore/default.aspx">https://www.atis.org/docstore/default.aspx</a>
CCSA	CCSA-TSD-LTE-36.141		10.12.0 Apr 15	<a href="http://www.ccsa.org.cn/ITU_spec/ITU-R/M.2012/M.2012-2/LTE/Rel-10/CCSA-TSD-LTE-36141-ac0.zip">http://www.ccsa.org.cn/ITU_spec/ITU-R/M.2012/M.2012-2/LTE/Rel-10/CCSA-TSD-LTE-36141-ac0.zip</a>
ETSI	ETSI TS 136 141		10.12.0 Oct 13	<a href="http://www.etsi.org/deliver/etsi_ts/136100_136199/136141/10.12.00_60/ts_136141v101200p.pdf">http://www.etsi.org/deliver/etsi_ts/136100_136199/136141/10.12.00_60/ts_136141v101200p.pdf</a>

**58**

TTA	TTAT.3G-36.141(R10-10.10.0)	10.10.0	Aug 13	<a href="http://www.tta.or.kr/data/ttasDown.jsp?where=14688&amp;pk_num=TTAT.3G-36.141(R10-10.10.0)">http://www.tta.or.kr/data/ttasDown.jsp?where=14688&amp;pk_num=TTAT.3G-36.141(R10-10.10.0)</a>
TTC	Not applicable			

**Release 11**

ARIB	ARIB STD-T104- 36.141	11.11.0	Mar 15	<a href="http://www.arib.or.jp/english/html/overview/doc/STD-T104v2_70/2_T104/ARIB-STD-T104/Rel11/36/A36141-bb0.pdf">http://www.arib.or.jp/english/html/overview/doc/STD-T104v2_70/2_T104/ARIB-STD-T104/Rel11/36/A36141-bb0.pdf</a>
ATIS	ATIS.3GPP.36.141V11110-2015	11.11.0	May 15	<a href="https://www.atis.org/docstore/default.aspx">https://www.atis.org/docstore/default.aspx</a>
CCSA	CCSA-TSD-LTE-36.141	11.11.0	Apr 15	<a href="http://www.ccsa.org.cn/ITU_spec/ITU-R/M.2012/M.2012-2/LTE/Rel-11/CCSA-TSD-LTE-36141-bb0.zip">http://www.ccsa.org.cn/ITU_spec/ITU-R/M.2012/M.2012-2/LTE/Rel-11/CCSA-TSD-LTE-36141-bb0.zip</a>
ETSI	ETSI TS 136 141	11.11.0	Feb 15	<a href="http://www.etsi.org/deliver/etsi_ts/136100_136199/136141/11.11.00_60/ts_136141v111100p.pdf">http://www.etsi.org/deliver/etsi_ts/136100_136199/136141/11.11.00_60/ts_136141v111100p.pdf</a>
TTA	TTAT.3G-36.141(R11-11.4.0)	11.4.0	Aug 13	<a href="http://www.tta.or.kr/data/ttasDown.jsp?where=14688&amp;pk_num=TTAT.3G-36.141(R11-11.4.0)">http://www.tta.or.kr/data/ttasDown.jsp?where=14688&amp;pk_num=TTAT.3G-36.141(R11-11.4.0)</a>
TTC	Not applicable			

**Release 12**

ARIB	Not applicable			
ATIS	ATIS.3GPP.36.141V1260-2015	12.6.0	May 15	<a href="https://www.atis.org/docstore/default.aspx">https://www.atis.org/docstore/default.aspx</a>
CCSA	CCSA-TSD-LTE-36.141	12.6.0	Apr 15	<a href="http://www.ccsa.org.cn/ITU_spec/ITU-R/M.2012/M.2012-2/LTE/Rel-12/CCSA-TSD-LTE-36141-c60.zip">http://www.ccsa.org.cn/ITU_spec/ITU-R/M.2012/M.2012-2/LTE/Rel-12/CCSA-TSD-LTE-36141-c60.zip</a>
ETSI	ETSI TS 136 141	12.6.0	Feb 15	<a href="http://www.etsi.org/deliver/etsi_ts/136100_136199/136141/12.06.00_60/ts_136141v120600p.pdf">http://www.etsi.org/deliver/etsi_ts/136100_136199/136141/12.06.00_60/ts_136141v120600p.pdf</a>
TTA	TTAT.3G-36.141(R12-12.6.0)	12.6.0	Apr 15	<a href="http://www.tta.or.kr/data/ttasDown.jsp?where=14688&amp;pk_num=TTAT.3G-36.141(R12-12.6.0)">http://www.tta.or.kr/data/ttasDown.jsp?where=14688&amp;pk_num=TTAT.3G-36.141(R12-12.6.0)</a>
TTC	Not applicable			

**1.2.1.5.12 TS 36.143****Evolved Universal Terrestrial Radio Access (E-UTRA); FDD repeater conformance testing**

This document specifies the Radio Frequency (RF) test methods and conformance requirements for E-UTRA FDD Repeater. These have been derived from, and are consistent with the E-UTRA FDD repeater specifications defined in TS 36.106.

<b>SDO (2)</b>	<b>Document No.</b>	<b>Version</b>	<b>Issued date</b>		<b>Location (1)</b>
<b>Release 10</b>					
ARIB	Not applicable				
ATIS	ATIS.3GPP.36.143V1070-2013	10.7.0	Jun 13		<a href="https://www.atis.org/docstore/default.aspx">https://www.atis.org/docstore/default.aspx</a>
CCSA	CCSA-TSD-LTE-36.143	10.7.0	Apr 15		<a href="http://www.ccsa.org.cn/ITU_spec/ITU-R/M.2012/M.2012-2/LTE/Rel-10/CCSA-TSD-LTE-36143-a70.zip">http://www.ccsa.org.cn/ITU_spec/ITU-R/M.2012/M.2012-2/LTE/Rel-10/CCSA-TSD-LTE-36143-a70.zip</a>
ETSI	ETSI TS 136 143	10.7.0	Apr 13		<a href="http://www.etsi.org/deliver/etsi_ts/136100_136199/136143/10.07.00_60/ts_136143v100700p.pdf">http://www.etsi.org/deliver/etsi_ts/136100_136199/136143/10.07.00_60/ts_136143v100700p.pdf</a>
TTA	TTAT.3G-36.143(R10-10.7.0)	10.7.0	Aug 13		<a href="http://www.tta.or.kr/data/ttasDown.jsp?where=14688&amp;pk_num=TTAT.3G-36.143(R10-10.7.0)">http://www.tta.or.kr/data/ttasDown.jsp?where=14688&amp;pk_num=TTAT.3G-36.143(R10-10.7.0)</a>
TTC	Not applicable				
<b>Release 11</b>					
ARIB	Not applicable				
ATIS	ATIS.3GPP.36.143V1120-2013	11.2.0	Jun 13		<a href="https://www.atis.org/docstore/default.aspx">https://www.atis.org/docstore/default.aspx</a>
CCSA	CCSA-TSD-LTE-36.143	11.2.0	Apr 15		<a href="http://www.ccsa.org.cn/ITU_spec/ITU-R/M.2012/M.2012-2/LTE/Rel-11/CCSA-TSD-LTE-36143-b20.zip">http://www.ccsa.org.cn/ITU_spec/ITU-R/M.2012/M.2012-2/LTE/Rel-11/CCSA-TSD-LTE-36143-b20.zip</a>
ETSI	ETSI TS 136 143	11.2.0	Apr 13		<a href="http://www.etsi.org/deliver/etsi_ts/136100_136199/136143/11.02.00_60/ts_136143v110200p.pdf">http://www.etsi.org/deliver/etsi_ts/136100_136199/136143/11.02.00_60/ts_136143v110200p.pdf</a>
TTA	TTAT.3G-36.143(R11-11.2.0)	11.2.0	Aug 13		<a href="http://www.tta.or.kr/data/ttasDown.jsp?where=14688&amp;pk_num=TTAT.3G-36.143(R11-11.2.0)">http://www.tta.or.kr/data/ttasDown.jsp?where=14688&amp;pk_num=TTAT.3G-36.143(R11-11.2.0)</a>
TTC	Not applicable				
<b>Release 12</b>					
ARIB	Not applicable				
ATIS	ATIS.3GPP.36.143V1210-2015	12.1.0	May 15		<a href="https://www.atis.org/docstore/default.aspx">https://www.atis.org/docstore/default.aspx</a>
CCSA	CCSA-TSD-LTE-36.143	12.1.0	Apr 15		<a href="http://www.ccsa.org.cn/ITU_spec/ITU-R/M.2012/M.2012-2/LTE/Rel-12/CCSA-TSD-LTE-36143-c10.zip">http://www.ccsa.org.cn/ITU_spec/ITU-R/M.2012/M.2012-2/LTE/Rel-12/CCSA-TSD-LTE-36143-c10.zip</a>
ETSI	ETSI TS 136 143	12.1.0	Feb 15		<a href="http://www.etsi.org/deliver/etsi_ts/136100_136199/136143/12.01.00_60/ts_136143v120100p.pdf">http://www.etsi.org/deliver/etsi_ts/136100_136199/136143/12.01.00_60/ts_136143v120100p.pdf</a>
TTA	TTAT.3G-36.143(R12-12.1.0)	12.1.0	Apr 15		<a href="http://www.tta.or.kr/data/ttasDown.jsp?where=14688&amp;pk_num=TTAT.3G-36.143(R12-12.1.0)">http://www.tta.or.kr/data/ttasDown.jsp?where=14688&amp;pk_num=TTAT.3G-36.143(R12-12.1.0)</a>

TTC Not applicable

### 1.2.1.5.13 TS 36.171

#### Evolved Universal Terrestrial Radio Access (E-UTRA); Requirements for Support of Assisted Global Navigation Satellite System (A-GNSS)

This document establishes the minimum performance requirements for A-GNSS (including A-GPS) for FDD or TDD mode of E-UTRA for the User Equipment (UE).

SDO (2)	Document No.	Version	Issued date	Location (1)
<b>Release 10</b>				
ARIB	ARIB STD-T104-36.171		10.2.0 Sep 13	<a href="http://www.arib.or.jp/english/html/overview/doc/STD-T104v2_10/2_T104/ARIB-STD-T104/Rel10/36/A36171-a20.pdf">http://www.arib.or.jp/english/html/overview/doc/STD-T104v2_10/2_T104/ARIB-STD-T104/Rel10/36/A36171-a20.pdf</a>
ATIS	ATIS.3GPP.36.171V1020-2015		10.2.0 May 15	<a href="https://www.atis.org/docstore/default.aspx">https://www.atis.org/docstore/default.aspx</a>
CCSA	CCSA-TSD-LTE-36.171		10.2.0 Apr 15	<a href="http://www.ccsa.org.cn/ITU_spec/ITU-R/M.2012/M.2012-2/LTE/Rel-10/CCSA-TSD-LTE-36171-a20.zip">http://www.ccsa.org.cn/ITU_spec/ITU-R/M.2012/M.2012-2/LTE/Rel-10/CCSA-TSD-LTE-36171-a20.zip</a>
ETSI	ETSI TS 136 171		10.2.0 Jul 13	<a href="http://www.etsi.org/deliver/etsi_ts/136100_136199/136171/10.02.00_60/ts_136171v100200p.pdf">http://www.etsi.org/deliver/etsi_ts/136100_136199/136171/10.02.00_60/ts_136171v100200p.pdf</a>
TTC	Not applicable			
<b>Release 11</b>				
ARIB	ARIB STD-T104-36.171		11.1.0 Sep 13	<a href="http://www.arib.or.jp/english/html/overview/doc/STD-T104v2_10/2_T104/ARIB-STD-T104/Rel11/36/A36171-b10.pdf">http://www.arib.or.jp/english/html/overview/doc/STD-T104v2_10/2_T104/ARIB-STD-T104/Rel11/36/A36171-b10.pdf</a>
ATIS	ATIS.3GPP.36.171V1110-2015		11.1.0 May 15	<a href="https://www.atis.org/docstore/default.aspx">https://www.atis.org/docstore/default.aspx</a>
CCSA	CCSA-TSD-LTE-36.171		11.1.0 Apr 15	<a href="http://www.ccsa.org.cn/ITU_spec/ITU-R/M.2012/M.2012-2/LTE/Rel-11/CCSA-TSD-LTE-36171-b10.zip">http://www.ccsa.org.cn/ITU_spec/ITU-R/M.2012/M.2012-2/LTE/Rel-11/CCSA-TSD-LTE-36171-b10.zip</a>
ETSI	ETSI TS 136 171		11.1.0 Jul 13	<a href="http://www.etsi.org/deliver/etsi_ts/136100_136199/136171/11.01.00_60/ts_136171v110100p.pdf">http://www.etsi.org/deliver/etsi_ts/136100_136199/136171/11.01.00_60/ts_136171v110100p.pdf</a>
TTA	TTAT.3G-36.171(R11-11.0.0)		11.0.0 Aug 13	<a href="http://www.tta.or.kr/data/ttasDown.jsp?where=14688&amp;pk_num=TTAT.3G-36.171(R11-11.0.0)">http://www.tta.or.kr/data/ttasDown.jsp?where=14688&amp;pk_num=TTAT.3G-36.171(R11-11.0.0)</a>
TTC	Not applicable			
<b>Release 12</b>				
ARIB	Not applicable			
ATIS	ATIS.3GPP.36.171V1210-2015		12.1.0 May 15	<a href="https://www.atis.org/docstore/default.aspx">https://www.atis.org/docstore/default.aspx</a>
CCSA	CCSA-TSD-LTE-36.171		12.1.0 Apr 15	<a href="http://www.ccsa.org.cn/ITU_spec/ITU-R/M.2012/M.2012-2/LTE/Rel-12/CCSA-TSD-LTE-36171-c10.zip">http://www.ccsa.org.cn/ITU_spec/ITU-R/M.2012/M.2012-2/LTE/Rel-12/CCSA-TSD-LTE-36171-c10.zip</a>
ETSI	ETSI TS 136 171		12.1.0 Feb 15	<a href="http://www.etsi.org/deliver/etsi_ts/136100_136199/136171/12.01.00_60/ts_136171v120100p.pdf">http://www.etsi.org/deliver/etsi_ts/136100_136199/136171/12.01.00_60/ts_136171v120100p.pdf</a>
TTA	TTAT.3G-36.171(R12-12.1.0)		12.1.0 Apr 15	<a href="http://www.tta.or.kr/data/ttasDown.jsp?where=14688&amp;pk_num=TTAT.3G-36.171(R12-12.1.0)">http://www.tta.or.kr/data/ttasDown.jsp?where=14688&amp;pk_num=TTAT.3G-36.171(R12-12.1.0)</a>
TTC	Not applicable			

### 1.2.1.5.14 TS 36.307

#### Evolved Universal Terrestrial Radio Access (E-UTRA); Requirements on User Equipments (UEs) supporting a release-independent frequency band

This document specifies requirements on UEs supporting a frequency band that is independent of release. TSG-RAN has agreed that the standardization of new frequency bands may be independent of a release. However, in order to implement a UE that conforms to a particular release but supports a band of operation that is specified in a later release, it is necessary to specify some extra requirements. All frequency bands are fully specified in this release of the specifications. This document does not contain any requirements for UEs supporting frequency bands independent of release.

SDO (2)	Document No.	Version	Issued date	Location (1)
<b>Release 10</b>				
ARIB	ARIB STD-T104-36.307		10.13.0 Mar 15	<a href="http://www.arib.or.jp/english/html/overview/doc/STD-T104v2_70/2_T104/ARIB-STD-T104/Rel10/36/A36307-ad0.pdf">http://www.arib.or.jp/english/html/overview/doc/STD-T104v2_70/2_T104/ARIB-STD-T104/Rel10/36/A36307-ad0.pdf</a>
ATIS	ATIS.3GPP.36.307V10130-2015		10.13.0 May 15	<a href="https://www.atis.org/docstore/default.aspx">https://www.atis.org/docstore/default.aspx</a>
CCSA	CCSA-TSD-LTE-36.307		10.13.0 Apr 15	<a href="http://www.ccsa.org.cn/ITU_spec/ITU-R/M.2012/M.2012-2/LTE/Rel-10/CCSA-TSD-LTE-36307-ad0.zip">http://www.ccsa.org.cn/ITU_spec/ITU-R/M.2012/M.2012-2/LTE/Rel-10/CCSA-TSD-LTE-36307-ad0.zip</a>
ETSI	ETSI TS 136 307		10.13.0 Feb 15	<a href="http://www.etsi.org/deliver/etsi_ts/136300_136399/136307/10.13.00_60/ts_136307v101300p.pdf">http://www.etsi.org/deliver/etsi_ts/136300_136399/136307/10.13.00_60/ts_136307v101300p.pdf</a>
TTC	Not applicable			
<b>Release 11</b>				
ARIB	ARIB STD-T104-36.307		11.10.0 Mar 15	<a href="http://www.arib.or.jp/english/html/overview/doc/STD-T104v2_70/2_T104/ARIB-STD-T104/Rel11/36/A36307-ba0.pdf">http://www.arib.or.jp/english/html/overview/doc/STD-T104v2_70/2_T104/ARIB-STD-T104/Rel11/36/A36307-ba0.pdf</a>
ATIS	ATIS.3GPP.36.307V11100-2015		11.10.0 May 15	<a href="https://www.atis.org/docstore/default.aspx">https://www.atis.org/docstore/default.aspx</a>
CCSA	CCSA-TSD-LTE-36.307		11.10.0 Apr 15	<a href="http://www.ccsa.org.cn/ITU_spec/ITU-R/M.2012/M.2012-2/LTE/Rel-11/CCSA-TSD-LTE-36307-ba0.zip">http://www.ccsa.org.cn/ITU_spec/ITU-R/M.2012/M.2012-2/LTE/Rel-11/CCSA-TSD-LTE-36307-ba0.zip</a>
ETSI	ETSI TS 136 307		11.10.0 Feb 15	<a href="http://www.etsi.org/deliver/etsi_ts/136300_136399/136307/11.10.00_60/ts_136307v111000p.pdf">http://www.etsi.org/deliver/etsi_ts/136300_136399/136307/11.10.00_60/ts_136307v111000p.pdf</a>
TTA	TTAT.3G-36.307(R11-11.3.0)		11.3.0 Aug 13	<a href="http://www.tta.or.kr/data/ttasDown.jsp?where=14688&amp;pk_num=TTAT.3G-36.307(R11-11.3.0)">http://www.tta.or.kr/data/ttasDown.jsp?where=14688&amp;pk_num=TTAT.3G-36.307(R11-11.3.0)</a>
TTC	Not applicable			
<b>Release 12</b>				
ARIB	Not applicable			
ATIS	ATIS.3GPP.36.307V1260-2015		12.6.0 May 15	<a href="https://www.atis.org/docstore/default.aspx">https://www.atis.org/docstore/default.aspx</a>
CCSA	CCSA-TSD-LTE-36.307		12.6.0 Apr 15	<a href="http://www.ccsa.org.cn/ITU_spec/ITU-R/M.2012/M.2012-2/LTE/Rel-12/CCSA-TSD-LTE-36307-c60.zip">http://www.ccsa.org.cn/ITU_spec/ITU-R/M.2012/M.2012-2/LTE/Rel-12/CCSA-TSD-LTE-36307-c60.zip</a>
ETSI	ETSI TS 136 307		12.6.0 Feb 15	<a href="http://www.etsi.org/deliver/etsi_ts/136300_136399/136307/12.06.00_60/ts_136307v120600p.pdf">http://www.etsi.org/deliver/etsi_ts/136300_136399/136307/12.06.00_60/ts_136307v120600p.pdf</a>
TTA	TTAT.3G-36.307(R12-12.6.0)		12.6.0 Apr 15	<a href="http://www.tta.or.kr/data/ttasDown.jsp?where=14688&amp;pk_num=TTAT.3G-36.307(R12-12.6.0)">http://www.tta.or.kr/data/ttasDown.jsp?where=14688&amp;pk_num=TTAT.3G-36.307(R12-12.6.0)</a>
TTC	Not applicable			

### 1.2.1.5.15 TS 37.104

#### E-UTRA, UTRA and GSM/EDGE; Multi-Standard Radio (MSR) Base Station (BS) radio transmission and reception

This document establishes the minimum RF characteristics of E-UTRA, UTRA and GSM/EDGE Multi-Standard Radio (MSR) Base Station (BS). Requirements for multi-RAT and single-RAT operation of MSR BS are covered in this document. The requirements in this document for E-UTRA and UTRA single-RAT operation of MSR BS are also applicable to E-UTRA and UTRA multi-carrier capable single-RAT BS. Requirements for GSM BS that are only single-RAT capable are not covered.

SDO (2)	Document No.	Version	Issued date	Location (1)
<b>Release 10</b>				
ARIB	Not applicable			
ATIS	ATIS.3GPP.37.104V10140-2015		10.14.0 May 15	<a href="https://www.atis.org/docstore/default.aspx">https://www.atis.org/docstore/default.aspx</a>
CCSA	CCSA-TSD-LTE-37.104		10.14.0 Apr 15	<a href="http://www.ccsa.org.cn/ITU_spec/ITU-R/M.2012/M.2012-2/LTE/Rel-10/CCSA-TSD-LTE-37104-ae0.zip">http://www.ccsa.org.cn/ITU_spec/ITU-R/M.2012/M.2012-2/LTE/Rel-10/CCSA-TSD-LTE-37104-ae0.zip</a>
ETSI	ETSI TS 137 104		10.14.0 Apr 14	<a href="http://www.etsi.org/deliver/etsi_ts/137100_137199/137104/10.14.00_60/ts_137104v101400p.pdf">http://www.etsi.org/deliver/etsi_ts/137100_137199/137104/10.14.00_60/ts_137104v101400p.pdf</a>
TTC	Not applicable			
<b>Release 11</b>				
ARIB	Not applicable			
ATIS	ATIS.3GPP.37.104V11110-2015		11.11.0 May 15	<a href="https://www.atis.org/docstore/default.aspx">https://www.atis.org/docstore/default.aspx</a>
CCSA	CCSA-TSD-LTE-37.104		11.11.0 Apr 15	<a href="http://www.ccsa.org.cn/ITU_spec/ITU-R/M.2012/M.2012-2/LTE/Rel-11/CCSA-TSD-LTE-37104-bb0.zip">http://www.ccsa.org.cn/ITU_spec/ITU-R/M.2012/M.2012-2/LTE/Rel-11/CCSA-TSD-LTE-37104-bb0.zip</a>
ETSI	ETSI TS 137 104		11.11.0 Feb 15	<a href="http://www.etsi.org/deliver/etsi_ts/137100_137199/137104/11.11.00_60/ts_137104v111100p.pdf">http://www.etsi.org/deliver/etsi_ts/137100_137199/137104/11.11.00_60/ts_137104v111100p.pdf</a>
TTA	TTAT.3G-37.104(R11-11.4.0)		11.4.0 Aug 13	<a href="http://www.tta.or.kr/data/ttasDown.jsp?where=14688&amp;pk_num=TTAT.3G-37.104(R11-11.4.0)">http://www.tta.or.kr/data/ttasDown.jsp?where=14688&amp;pk_num=TTAT.3G-37.104(R11-11.4.0)</a>

TTC	Not applicable			
<b>Release 12</b>				
ARIB	Not applicable			
ATIS	ATIS.3GPP.37.104V1260-2015	12.6.0	May 15	<a href="https://www.atis.org/docstore/default.aspx">https://www.atis.org/docstore/default.aspx</a>
CCSA	CCSA-TSD-LTE-37.104	12.6.0	Apr 15	<a href="http://www.ccsa.org.cn/ITU_spec/ITU-R/M.2012/M.2012-2/LTE/Rel-12/CCSA-TSD-LTE-37104-c60.zip">http://www.ccsa.org.cn/ITU_spec/ITU-R/M.2012/M.2012-2/LTE/Rel-12/CCSA-TSD-LTE-37104-c60.zip</a>
ETSI	ETSI TS 137 104	12.6.0	Feb 15	<a href="http://www.etsi.org/deliver/etsi_ts/137100_137199/137104/12.06.00_60/ts_137104v120600p.pdf">http://www.etsi.org/deliver/etsi_ts/137100_137199/137104/12.06.00_60/ts_137104v120600p.pdf</a>
TTA	TTAT.3G-37.104(R12-12.6.0)	12.6.0	Apr 15	<a href="http://www.tta.or.kr/data/ttasDown.jsp?where=14688&amp;pk_num=TTAT.3G-37.104(R12-12.6.0)">http://www.tta.or.kr/data/ttasDown.jsp?where=14688&amp;pk_num=TTAT.3G-37.104(R12-12.6.0)</a>
TTC	Not applicable			

### 1.2.1.5.16 TS 37.141

#### E-UTRA, UTRA and GSM/EDGE; Multi-Standard Radio (MSR) Base Station (BS) conformance testing

This document specifies the Radio Frequency (RF) test methods and conformance requirements for E-UTRA, UTRA and GSM/EDGE Multi-Standard Radio (MSR) Base Station (BS).

SDO (2)	Document No.	Version	Issued date	Location (1)
<b>Release 10</b>				
ARIB	Not applicable			
ATIS	ATIS.3GPP.37.141V10140-2015	10.14.0	May 15	<a href="https://www.atis.org/docstore/default.aspx">https://www.atis.org/docstore/default.aspx</a>
CCSA	CCSA-TSD-LTE-37.141	10.14.0	Apr 15	<a href="http://www.ccsa.org.cn/ITU_spec/ITU-R/M.2012/M.2012-2/LTE/Rel-10/CCSA-TSD-LTE-37141-ae0.zip">http://www.ccsa.org.cn/ITU_spec/ITU-R/M.2012/M.2012-2/LTE/Rel-10/CCSA-TSD-LTE-37141-ae0.zip</a>
ETSI	ETSI TS 137 141	10.14.0	Feb 15	<a href="http://www.etsi.org/deliver/etsi_ts/137100_137199/137141/10.14.00_60/ts_137141v101400p.pdf">http://www.etsi.org/deliver/etsi_ts/137100_137199/137141/10.14.00_60/ts_137141v101400p.pdf</a>
TTC	Not applicable			
<b>Release 11</b>				
ARIB	Not applicable			
ATIS	ATIS.3GPP.37.141V11110-2015	11.11.0	May 15	<a href="https://www.atis.org/docstore/default.aspx">https://www.atis.org/docstore/default.aspx</a>
CCSA	CCSA-TSD-LTE-37.141	11.11.0	Apr 15	<a href="http://www.ccsa.org.cn/ITU_spec/ITU-R/M.2012/M.2012-2/LTE/Rel-11/CCSA-TSD-LTE-37141-bb0.zip">http://www.ccsa.org.cn/ITU_spec/ITU-R/M.2012/M.2012-2/LTE/Rel-11/CCSA-TSD-LTE-37141-bb0.zip</a>
ETSI	ETSI TS 137 141	11.11.0	Feb 15	<a href="http://www.etsi.org/deliver/etsi_ts/137100_137199/137141/11.11.00_60/ts_137141v111100p.pdf">http://www.etsi.org/deliver/etsi_ts/137100_137199/137141/11.11.00_60/ts_137141v111100p.pdf</a>
TTA	TTAT.3G-37.141(R11-11.4.0)	11.4.0	Aug 13	<a href="http://www.tta.or.kr/data/ttasDown.jsp?where=14688&amp;pk_num=TTAT.3G-37.141(R11-11.4.0)">http://www.tta.or.kr/data/ttasDown.jsp?where=14688&amp;pk_num=TTAT.3G-37.141(R11-11.4.0)</a>
TTC	Not applicable			
<b>Release 12</b>				
ARIB	Not applicable			
ATIS	ATIS.3GPP.37.141V1260-2015	12.6.0	May 15	<a href="https://www.atis.org/docstore/default.aspx">https://www.atis.org/docstore/default.aspx</a>
CCSA	CCSA-TSD-LTE-37.141	12.6.0	Apr 15	<a href="http://www.ccsa.org.cn/ITU_spec/ITU-R/M.2012/M.2012-2/LTE/Rel-12/CCSA-TSD-LTE-37141-c60.zip">http://www.ccsa.org.cn/ITU_spec/ITU-R/M.2012/M.2012-2/LTE/Rel-12/CCSA-TSD-LTE-37141-c60.zip</a>
ETSI	ETSI TS 137 141	12.6.0	Feb 15	<a href="http://www.etsi.org/deliver/etsi_ts/137100_137199/137141/12.06.00_60/ts_137141v120600p.pdf">http://www.etsi.org/deliver/etsi_ts/137100_137199/137141/12.06.00_60/ts_137141v120600p.pdf</a>
TTA	TTAT.3G-37.141(R12-12.6.0)	12.6.0	Apr 15	<a href="http://www.tta.or.kr/data/ttasDown.jsp?where=14688&amp;pk_num=TTAT.3G-37.141(R12-12.6.0)">http://www.tta.or.kr/data/ttasDown.jsp?where=14688&amp;pk_num=TTAT.3G-37.141(R12-12.6.0)</a>
TTC	Not applicable			

### 1.2.1.5.17 TS 37.113

#### E-UTRA, UTRA and GSM/EDGE; Multi-Standard Radio (MSR) Base Station (BS) Electromagnetic Compatibility (EMC)

This document covers the assessment of E-UTRA, UTRA and GSM/EDGE Multi-Standard Radio (MSR) Base Stations and associated ancillary equipment in respect of Electromagnetic Compatibility (EMC). This document specifies the applicable test conditions, performance assessment and

performance criteria for E-UTRA, UTRA and GSM/EDGE Base Stations and associated ancillary equipment in one of the following categories: (i) Multi-Standard Radio (MSR) Base Stations for E-UTRA, UTRA and GSM/EDGE meeting the requirements of TS 37.104, with conformance demonstrated by compliance to TS 37.141; (ii) Base Stations for E-UTRA meeting the requirements of TS 36.104, with conformance demonstrated by compliance to TS 36.141; (iii) Base Stations for UTRA FDD meeting the requirements of TS 25.104, with conformance demonstrated by compliance to TS 25.141; (iv) Base Stations for UTRA TDD meeting the requirements of TS 25.105, with conformance demonstrated by compliance to TS 25.142; (v) Base Stations for GSM/EDGE meeting the requirements of TS 45.005, with conformance demonstrated by compliance to TS 51.021. The environment classification used in this document refers to the environment classification used in IEC 61000-6-1 and IEC 61000-6-3.

The EMC requirements have been selected to ensure an adequate level of compatibility for apparatus at residential, commercial and light industrial environments. The levels, however, do not cover extreme cases which may occur in any location but with low probability of occurrence.

SDO (2)	Document No.	Version	Issued date		Location (1)
<b>Release 10</b>					
ARIB	Not applicable				
ATIS	ATIS.3GPP.37.113V1040-2013	10.4.0	Jun	13	<a href="https://www.atis.org/docstore/default.aspx">https://www.atis.org/docstore/default.aspx</a>
CCSA	CCSA-TSD-LTE-37.113	10.4.0	Apr	15	<a href="http://www.ccsa.org.cn/ITU_spec/ITU-R/M.2012/M.2012-2/LTE/Rel-10/CCSA-TSD-LTE-37113-a40.zip">http://www.ccsa.org.cn/ITU_spec/ITU-R/M.2012/M.2012-2/LTE/Rel-10/CCSA-TSD-LTE-37113-a40.zip</a>
ETSI	ETSI TS 137 113	10.4.0	Jan	12	<a href="http://www.etsi.org/deliver/etsi_ts/137100_137199/137113/10.04.00_60/ts_137113v100400p.pdf">http://www.etsi.org/deliver/etsi_ts/137100_137199/137113/10.04.00_60/ts_137113v100400p.pdf</a>
TTC	Not applicable				
<b>Release 11</b>					
ARIB	Not applicable				
ATIS	ATIS.3GPP.37.113V1130-2015	11.3.0	May	15	<a href="https://www.atis.org/docstore/default.aspx">https://www.atis.org/docstore/default.aspx</a>
CCSA	CCSA-TSD-LTE-37.113	11.3.0	Apr	15	<a href="http://www.ccsa.org.cn/ITU_spec/ITU-R/M.2012/M.2012-2/LTE/Rel-11/CCSA-TSD-LTE-37113-b30.zip">http://www.ccsa.org.cn/ITU_spec/ITU-R/M.2012/M.2012-2/LTE/Rel-11/CCSA-TSD-LTE-37113-b30.zip</a>
ETSI	ETSI TS 137 113	11.3.0	Feb	15	<a href="http://www.etsi.org/deliver/etsi_ts/137100_137199/137113/11.03.00_60/ts_137113v110300p.pdf">http://www.etsi.org/deliver/etsi_ts/137100_137199/137113/11.03.00_60/ts_137113v110300p.pdf</a>
TTA	TTAT.3G-37.113(R11-11.1.0)	11.1.0	Aug	13	<a href="http://www.tta.or.kr/data/ttasDown.jsp?where=14688&amp;pk_num=TTAT.3G-37.113(R11-11.1.0)">http://www.tta.or.kr/data/ttasDown.jsp?where=14688&amp;pk_num=TTAT.3G-37.113(R11-11.1.0)</a>
TTC	Not applicable				
<b>Release 12</b>					
ARIB	Not applicable				
ATIS	ATIS.3GPP.37.113V1230-2015	12.3.0	May	15	<a href="https://www.atis.org/docstore/default.aspx">https://www.atis.org/docstore/default.aspx</a>
CCSA	CCSA-TSD-LTE-37.113	12.3.0	Apr	15	<a href="http://www.ccsa.org.cn/ITU_spec/ITU-R/M.2012/M.2012-2/LTE/Rel-12/CCSA-TSD-LTE-37113-c30.zip">http://www.ccsa.org.cn/ITU_spec/ITU-R/M.2012/M.2012-2/LTE/Rel-12/CCSA-TSD-LTE-37113-c30.zip</a>
ETSI	ETSI TS 137 113	12.3.0	Feb	15	<a href="http://www.etsi.org/deliver/etsi_ts/137100_137199/137113/12.03.00_60/ts_137113v120300p.pdf">http://www.etsi.org/deliver/etsi_ts/137100_137199/137113/12.03.00_60/ts_137113v120300p.pdf</a>
TTA	TTAT.3G-37.113(R12-12.3.0)	12.3.0	Apr	15	<a href="http://www.tta.or.kr/data/ttasDown.jsp?where=14688&amp;pk_num=TTAT.3G-37.113(R12-12.3.0)">http://www.tta.or.kr/data/ttasDown.jsp?where=14688&amp;pk_num=TTAT.3G-37.113(R12-12.3.0)</a>
TTC	Not applicable				

### 1.2.1.5.18 TS 37.320

#### Radio measurement collection for Minimization of Drive Tests (MDT); Overall description; Stage 2

This document provides an overview and overall description of the minimization of drive tests functionality. The document describes functions and procedures to support collection of UE-specific measurements for MDT using Control Plane architecture, for both UTRAN and E-UTRAN. Details of the signalling procedures for single-RAT operation are specified in the appropriate radio interface protocol specification. Network operation and overall control of MDT is described in OAM specifications.



SDO (2)	Document No.	Version	Issued date	Location (1)
<b>Release 10</b>				
ARIB	ARIB STD-T104-37.320		10.4.0 Sep 13	<a href="http://www.arib.or.jp/english/html/overview/doc/STD-T104v2_10/2_T104/ARIB-STD-T104/Rel10//37/A37320-a40.pdf">http://www.arib.or.jp/english/html/overview/doc/STD-T104v2_10/2_T104/ARIB-STD-T104/Rel10//37/A37320-a40.pdf</a>
ATIS	ATIS.3GPP.37.320V1040-2013		10.4.0 Jun 13	<a href="https://www.atis.org/docstore/default.aspx">https://www.atis.org/docstore/default.aspx</a>
CCSA	CCSA-TSD-LTE-37.320		10.4.0 Apr 15	<a href="http://www.ccsa.org.cn/ITU_spec/ITU-R/M.2012/M.2012-2/LTE/Rel-10/CCSA-TSD-LTE-37320-a40.zip">http://www.ccsa.org.cn/ITU_spec/ITU-R/M.2012/M.2012-2/LTE/Rel-10/CCSA-TSD-LTE-37320-a40.zip</a>
ETSI	ETSI TS 137 320		10.4.0 Jan 12	<a href="http://www.etsi.org/deliver/etsi_ts/137300_137399/137320/10.04.00_60/ts_137320v100400p.pdf">http://www.etsi.org/deliver/etsi_ts/137300_137399/137320/10.04.00_60/ts_137320v100400p.pdf</a>
TTA	TTAT.3G-37.320(R10-10.4.0)		10.4.0 Aug 13	<a href="http://www.tta.or.kr/data/ttasDown.jsp?where=14688&amp;pk_num=TTAT.3G-37.320(R10-10.4.0)">http://www.tta.or.kr/data/ttasDown.jsp?where=14688&amp;pk_num=TTAT.3G-37.320(R10-10.4.0)</a>
TTC	Not applicable			
<b>Release 11</b>				
ARIB	ARIB STD-T104-37.320		11.4.0 Dec 14	<a href="http://www.arib.or.jp/english/html/overview/doc/STD-T104v2_60/2_T104/ARIB-STD-T104/Rel11/37/A37320-b40.pdf">http://www.arib.or.jp/english/html/overview/doc/STD-T104v2_60/2_T104/ARIB-STD-T104/Rel11/37/A37320-b40.pdf</a>
ATIS	ATIS.3GPP.37.320V1140-2015		11.4.0 May 15	<a href="https://www.atis.org/docstore/default.aspx">https://www.atis.org/docstore/default.aspx</a>
CCSA	CCSA-TSD-LTE-37.320		11.4.0 Apr 15	<a href="http://www.ccsa.org.cn/ITU_spec/ITU-R/M.2012/M.2012-2/LTE/Rel-11/CCSA-TSD-LTE-37320-b40.zip">http://www.ccsa.org.cn/ITU_spec/ITU-R/M.2012/M.2012-2/LTE/Rel-11/CCSA-TSD-LTE-37320-b40.zip</a>
ETSI	ETSI TS 137 320		11.4.0 Sep 14	<a href="http://www.etsi.org/deliver/etsi_ts/137300_137399/137320/11.04.00_60/ts_137320v110400p.pdf">http://www.etsi.org/deliver/etsi_ts/137300_137399/137320/11.04.00_60/ts_137320v110400p.pdf</a>
TTA	TTAT.3G-37.320(R11-11.3.0)		11.3.0 Aug 13	<a href="http://www.tta.or.kr/data/ttasDown.jsp?where=14688&amp;pk_num=TTAT.3G-37.320(R11-11.3.0)">http://www.tta.or.kr/data/ttasDown.jsp?where=14688&amp;pk_num=TTAT.3G-37.320(R11-11.3.0)</a>
TTC	Not applicable			
<b>Release 12</b>				
ARIB	Not applicable			
ATIS	ATIS.3GPP.37.320V1220-2015		12.2.0 May 15	<a href="https://www.atis.org/docstore/default.aspx">https://www.atis.org/docstore/default.aspx</a>
CCSA	CCSA-TSD-LTE-37.320		12.2.0 Apr 15	<a href="http://www.ccsa.org.cn/ITU_spec/ITU-R/M.2012/M.2012-2/LTE/Rel-12/CCSA-TSD-LTE-37320-c20.zip">http://www.ccsa.org.cn/ITU_spec/ITU-R/M.2012/M.2012-2/LTE/Rel-12/CCSA-TSD-LTE-37320-c20.zip</a>
ETSI	ETSI TS 137 320		12.2.0 Sep 14	<a href="http://www.etsi.org/deliver/etsi_ts/137300_137399/137320/12.02.00_60/ts_137320v120200p.pdf">http://www.etsi.org/deliver/etsi_ts/137300_137399/137320/12.02.00_60/ts_137320v120200p.pdf</a>
TTA	TTAT.3G-37.320(R12-12.2.0)		12.2.0 Apr 15	<a href="http://www.tta.or.kr/data/ttasDown.jsp?where=14688&amp;pk_num=TTAT.3G-37.320(R12-12.2.0)">http://www.tta.or.kr/data/ttasDown.jsp?where=14688&amp;pk_num=TTAT.3G-37.320(R12-12.2.0)</a>
TTC	Not applicable			

### 1.2.1.6 User Equipment (UE) conformance testing

#### 1.2.1.6.1 TS 36.508

#### Evolved Universal Terrestrial Radio Access (E-UTRA) and Evolved Packet Core (EPC); Common test environments for User Equipment (UE) conformance testing

This document contains definitions of reference conditions and test signals, default parameters, reference radio bearer configurations used in radio bearer interoperability testing, common radio bearer configurations for other test purposes, common requirements for test equipment and generic set-up procedures for use in conformance tests for the 3<sup>rd</sup> Generation E-UTRAN User Equipment (UE).

SDO (2)	Document No.	Version	Issued date	Location (1)
<b>Release 10</b>				
ARIB	ARIB STD-T104-36.508		10.5.0 Sep 13	<a href="http://www.arib.or.jp/english/html/overview/doc/STD-T104v2_10/2_T104/ARIB-STD-T104/Rel10/36/A36508-a50.pdf">http://www.arib.or.jp/english/html/overview/doc/STD-T104v2_10/2_T104/ARIB-STD-T104/Rel10/36/A36508-a50.pdf</a>
ATIS	ATIS.3GPP.36.508V1050-2015		10.5.0 May 15	<a href="https://www.atis.org/docstore/default.aspx">https://www.atis.org/docstore/default.aspx</a>
CCSA	CCSA-TSD-LTE-36.508		10.5.0 Apr 15	<a href="http://www.ccsa.org.cn/ITU_spec/ITU-R/M.2012/M.2012-2/LTE/Rel-10/CCSA-TSD-LTE-36508-a50.zip">http://www.ccsa.org.cn/ITU_spec/ITU-R/M.2012/M.2012-2/LTE/Rel-10/CCSA-TSD-LTE-36508-a50.zip</a>
ETSI	ETSI TS 136 508		10.5.0 Jul 13	<a href="http://www.etsi.org/deliver/etsi_ts/136500_136599/136508/10.05.00_60/ts_136508v100500p.pdf">http://www.etsi.org/deliver/etsi_ts/136500_136599/136508/10.05.00_60/ts_136508v100500p.pdf</a>
TTA	TTAT.3G-36.508(R10-10.4.0)		10.4.0 Aug 13	<a href="http://www.tta.or.kr/data/ttasDown.jsp?where=14688&amp;pk_num=TTAT.3G-36.508(R10-10.4.0)">http://www.tta.or.kr/data/ttasDown.jsp?where=14688&amp;pk_num=TTAT.3G-36.508(R10-10.4.0)</a>
TTC	Not applicable			
<b>Release 11</b>				
ARIB	ARIB STD-T104-36.508		11.4.0 Jul 14	<a href="http://www.arib.or.jp/english/html/overview/doc/STD-T104v2_40/2_T104/ARIB-STD-T104/Rel11/36/A36508-b40.pdf">http://www.arib.or.jp/english/html/overview/doc/STD-T104v2_40/2_T104/ARIB-STD-T104/Rel11/36/A36508-b40.pdf</a>

## 64

## Rec. ITU-R M.2012-2

ATIS	ATIS.3GPP.36.508V1140-2015	11.4.0	May 15	<a href="https://www.atis.org/docstore/default.aspx">https://www.atis.org/docstore/default.aspx</a>
CCSA	CCSA-TSD-LTE-36.508	11.4.0	Apr 15	<a href="http://www.ccsa.org.cn/ITU_spec/ITU-R/M.2012/M.2012-2/LTE/Rel-11/CCSA-TSD-LTE-36508-b40.zip">http://www.ccsa.org.cn/ITU_spec/ITU-R/M.2012/M.2012-2/LTE/Rel-11/CCSA-TSD-LTE-36508-b40.zip</a>
ETSI	ETSI TS 136 508	11.4.0	Apr 14	<a href="http://www.etsi.org/deliver/etsi_ts/136500_136508/11.04.00_60/ts_136508v110400p.pdf">http://www.etsi.org/deliver/etsi_ts/136500_136508/11.04.00_60/ts_136508v110400p.pdf</a>
TTA	TTAT.3G-36.508(R11-11.0.0)	11.0.0	Aug 13	<a href="http://www.tta.or.kr/data/ttasDown.jsp?where=14688&amp;pk_num=TTAT.3G-36.508(R11-11.0.0)">http://www.tta.or.kr/data/ttasDown.jsp?where=14688&amp;pk_num=TTAT.3G-36.508(R11-11.0.0)</a>
TTC	Not applicable			

### Release 12

ARIB	Not applicable			
ATIS	ATIS.3GPP.36.508V1241-2015	12.4.1	May 15	<a href="https://www.atis.org/docstore/default.aspx">https://www.atis.org/docstore/default.aspx</a>
CCSA	CCSA-TSD-LTE-36.508	12.4.1	Apr 15	<a href="http://www.ccsa.org.cn/ITU_spec/ITU-R/M.2012/M.2012-2/LTE/Rel-12/CCSA-TSD-LTE-36508-c41.zip">http://www.ccsa.org.cn/ITU_spec/ITU-R/M.2012/M.2012-2/LTE/Rel-12/CCSA-TSD-LTE-36508-c41.zip</a>
ETSI	ETSI TS 136 508	12.4.1	Apr 15	<a href="http://www.etsi.org/deliver/etsi_ts/136500_136599/136508/12.04.01_60/ts_136508v120401p.pdf">http://www.etsi.org/deliver/etsi_ts/136500_136599/136508/12.04.01_60/ts_136508v120401p.pdf</a>
TTA	TTAT.3G-36.508(R12-12.4.1)	12.4.1	Apr 15	<a href="http://www.tta.or.kr/data/ttasDown.jsp?where=14688&amp;pk_num=TTAT.3G-36.508(R12-12.4.1)">http://www.tta.or.kr/data/ttasDown.jsp?where=14688&amp;pk_num=TTAT.3G-36.508(R12-12.4.1)</a>
TTC	Not applicable			

### 1.2.1.6.2 TS 36.509

#### Evolved Universal Terrestrial Radio Access (E-UTRA) and Evolved Packet Core (EPC); Special conformance testing functions for User Equipment (UE)

This document defines for User Equipment (UE) in E-UTRA FDD or TDD mode those special functions and their activation/deactivation methods that are required in UE for conformance testing purposes.

This document also describes the operation of these special functions for UEs supporting E-UTRA FDD or TDD mode, when operating in UTRA FDD and TDD mode, in GSM/GPRS mode, and in CDMA2000 mode.

#### SDO (2) Document No. Version Issued date Location (1)

##### Release 10

ARIB	ARIB STD-T104-36.509	10.3.0	Dec 14	<a href="http://www.arib.or.jp/english/html/overview/doc/STD-T104v2_60/2_T104/ARIB-STD-T104/Rel10/36/A36509-a30.pdf">http://www.arib.or.jp/english/html/overview/doc/STD-T104v2_60/2_T104/ARIB-STD-T104/Rel10/36/A36509-a30.pdf</a>
ATIS	ATIS.3GPP.36.509V1030-2015	10.3.0	May 15	<a href="https://www.atis.org/docstore/default.aspx">https://www.atis.org/docstore/default.aspx</a>
CCSA	CCSA-TSD-LTE-36.509	10.3.0	Apr 15	<a href="http://www.ccsa.org.cn/ITU_spec/ITU-R/M.2012/M.2012-2/LTE/Rel-10/CCSA-TSD-LTE-36509-a30.zip">http://www.ccsa.org.cn/ITU_spec/ITU-R/M.2012/M.2012-2/LTE/Rel-10/CCSA-TSD-LTE-36509-a30.zip</a>
ETSI	ETSI TS 136 509	10.3.0	Sep 14	<a href="http://www.etsi.org/deliver/etsi_ts/136500_136599/136509/10.03.00_60/ts_136509v100300p.pdf">http://www.etsi.org/deliver/etsi_ts/136500_136599/136509/10.03.00_60/ts_136509v100300p.pdf</a>
TTA	TTAT.3G-36.509(R10-10.0.0)	10.0.0	Aug 13	<a href="http://www.tta.or.kr/data/ttasDown.jsp?where=14688&amp;pk_num=TTAT.3G-36.509(R10-10.0.0)">http://www.tta.or.kr/data/ttasDown.jsp?where=14688&amp;pk_num=TTAT.3G-36.509(R10-10.0.0)</a>
TTC	Not applicable			

### 1.2.1.6.3 TS 36.521-1

#### Evolved Universal Terrestrial Radio Access (E-UTRA); User Equipment (UE) conformance specification; Radio transmission and reception; Part 1: Conformance testing

This document specifies the measurement procedures for the conformance test of the user equipment (UE) that contain transmitting characteristics, receiving characteristics and performance requirements as part of the 3G Long Term Evolution (3G LTE). Conformance test for the support of RRM (Radio Resource Management) are specified in TS 36.521-3.

The requirements are listed in different clauses only if the corresponding parameters deviate. More generally, tests are only applicable to those mobiles that are intended to support the appropriate functionality. To indicate the circumstances in which tests apply, this is noted in the “definition and applicability” part of the test.

For example only Release 8 and later UE declared to support LTE shall be tested for this functionality. In the event that for some tests different conditions apply for different releases, this is indicated within the text of the test itself.

SDO (2)	Document No.	Version	Issued date	Location (1)
<b>Release 10</b>				
ARIB	ARIB STD-T104-36.521-1		10.6.0 Sep 13	<a href="http://www.arib.or.jp/english/html/overview/doc/STD-T104v2_10/2_T104/ARIB-STD-T104/Rel10/36/A36521-1-a60.pdf">http://www.arib.or.jp/english/html/overview/doc/STD-T104v2_10/2_T104/ARIB-STD-T104/Rel10/36/A36521-1-a60.pdf</a>
ATIS	ATIS.3GPP.36.521-1V1060-2015		10.6.0 May 15	<a href="https://www.atis.org/docstore/default.aspx">https://www.atis.org/docstore/default.aspx</a>
CCSA	CCSA-TSD-LTE-36.521-1		10.6.0 Apr 15	<a href="http://www.ccsa.org.cn/ITU_spec/ITU-R/M.2012/M.2012-2/LTE/Rel-10/CCSA-TSD-LTE-36521-1-a60.zip">http://www.ccsa.org.cn/ITU_spec/ITU-R/M.2012/M.2012-2/LTE/Rel-10/CCSA-TSD-LTE-36521-1-a60.zip</a>
ETSI	ETSI TS 136 521-1		10.6.0 Jul 13	<a href="http://www.etsi.org/deliver/etsi_ts/136500_136599/13652101/10.06.00_60/ts_13652101v100600p.pdf">http://www.etsi.org/deliver/etsi_ts/136500_136599/13652101/10.06.00_60/ts_13652101v100600p.pdf</a>
TTA	TTAT.3G-36.521-1(R10-10.5.0)		10.5.0 Aug 13	<a href="http://www.tta.or.kr/data/ttasDown.jsp?where=14688&amp;pk_num=TTAT.3G-36.521-1(R10-10.5.0)">http://www.tta.or.kr/data/ttasDown.jsp?where=14688&amp;pk_num=TTAT.3G-36.521-1(R10-10.5.0)</a>
TTC	Not applicable			
<b>Release 11</b>				
ARIB	ARIB STD-T104-36.521-1		11.4.0 Jul 14	<a href="http://www.arib.or.jp/english/html/overview/doc/STD-T104v2_40/2_T104/ARIB-STD-T104/Rel11/36/A36521-1-b40.pdf">http://www.arib.or.jp/english/html/overview/doc/STD-T104v2_40/2_T104/ARIB-STD-T104/Rel11/36/A36521-1-b40.pdf</a>
ATIS	ATIS.3GPP.36.521-1V1140-2015		11.4.0 May 15	<a href="https://www.atis.org/docstore/default.aspx">https://www.atis.org/docstore/default.aspx</a>
CCSA	CCSA-TSD-LTE-36.521-1		11.4.0 Apr 15	<a href="http://www.ccsa.org.cn/ITU_spec/ITU-R/M.2012/M.2012-2/LTE/Rel-11/CCSA-TSD-LTE-36521-1-b40.zip">http://www.ccsa.org.cn/ITU_spec/ITU-R/M.2012/M.2012-2/LTE/Rel-11/CCSA-TSD-LTE-36521-1-b40.zip</a>
ETSI	ETSI TS 136 521-1		11.4.0 Mar 14	<a href="http://www.etsi.org/deliver/etsi_ts/136500_136599/13652101/11.04.00_60/ts_13652101v110400p.pdf">http://www.etsi.org/deliver/etsi_ts/136500_136599/13652101/11.04.00_60/ts_13652101v110400p.pdf</a>
TTA	TTAT.3G-36.521-1(R11-11.0.1)		11.0.1 Aug 13	<a href="http://www.tta.or.kr/data/ttasDown.jsp?where=14688&amp;pk_num=TTAT.3G-36.521-1(R11-11.0.1)">http://www.tta.or.kr/data/ttasDown.jsp?where=14688&amp;pk_num=TTAT.3G-36.521-1(R11-11.0.1)</a>
TTC	Not applicable			
<b>Release 12</b>				
ARIB	Not applicable			
ATIS	ATIS.3GPP.36.521-1V1240-2015		12.4.0 May 15	<a href="https://www.atis.org/docstore/default.aspx">https://www.atis.org/docstore/default.aspx</a>
CCSA	CCSA-TSD-LTE-36.521-1		12.4.0 Apr 15	<a href="http://www.ccsa.org.cn/ITU_spec/ITU-R/M.2012/M.2012-2/LTE/Rel-12/CCSA-TSD-LTE-36521-1-c40.zip">http://www.ccsa.org.cn/ITU_spec/ITU-R/M.2012/M.2012-2/LTE/Rel-12/CCSA-TSD-LTE-36521-1-c40.zip</a>
ETSI	ETSI TS 136 521-1		12.4.0 Mar 15	<a href="http://www.etsi.org/deliver/etsi_ts/136500_136599/13652101/12.04.00_60/ts_13652101v120400p.pdf">http://www.etsi.org/deliver/etsi_ts/136500_136599/13652101/12.04.00_60/ts_13652101v120400p.pdf</a>
TTA	TTAT.3G-36.521-1(R12-12.4.0)		12.4.0 Apr 15	<a href="http://www.tta.or.kr/data/ttasDown.jsp?where=14688&amp;pk_num=TTAT.3G-36.521-1(R12-12.4.0)">http://www.tta.or.kr/data/ttasDown.jsp?where=14688&amp;pk_num=TTAT.3G-36.521-1(R12-12.4.0)</a>
TTC	Not applicable			

#### 1.2.1.6.4 TS 36.521-2

### Evolved Universal Terrestrial Radio Access (E-UTRA); User Equipment (UE) conformance specification; Radio transmission and reception; Part 2: Implementation Conformance Statement (ICS)

This document provides the ICS proforma for 3G Evolved Universal Terrestrial Radio Access (E-UTRA) User Equipment (UE), in compliance with the relevant requirements, and in accordance with the relevant guidance given in ISO/IEC 9646-1 and ISO/IEC 9646-7.

This document specifies the recommended applicability statement for the test cases included in 3GPP TS 36.521-1 and 3GPP TS 36.521-3. These applicability statements are based on the features implemented in the UE.

Special conformance testing functions can be found in 3GPP TS 36.509 and the common test environments are included in 3GPP TS 36.508.

This document is valid for UE implemented according to 3GPP releases starting from Release 8 up to the Release indicated on the cover page of this document.

SDO (2)	Document No.	Version	Issued date	Location (1)
<b>Release 10</b>				
ARIB	ARIB STD-T104-36.521-2		10.6.0 Sep 13	<a href="http://www.arib.or.jp/english/html/overview/doc/STD-T104v2_10/2_T104/ARIB-STD-T104/Rel10/36/A36521-2-a60.pdf">http://www.arib.or.jp/english/html/overview/doc/STD-T104v2_10/2_T104/ARIB-STD-T104/Rel10/36/A36521-2-a60.pdf</a>
ATIS	ATIS.3GPP.36.521-2V1060-2015		10.6.0 May 15	<a href="https://www.atis.org/docstore/default.aspx">https://www.atis.org/docstore/default.aspx</a>
CCSA	CCSA-TSD-LTE-36.521-2		10.6.0 Apr 15	<a href="http://www.ccsa.org.cn/ITU_spec/ITU-R/M.2012/M.2012-2/LTE/Rel-10/CCSA-TSD-LTE-36521-2-a60.zip">http://www.ccsa.org.cn/ITU_spec/ITU-R/M.2012/M.2012-2/LTE/Rel-10/CCSA-TSD-LTE-36521-2-a60.zip</a>
ETSI	ETSI TS 136 521-2		10.6.0 Jul 13	<a href="http://www.etsi.org/deliver/etsi_ts/136500_136599/13652102/10.06.00_60/ts_13652102v100600p.pdf">http://www.etsi.org/deliver/etsi_ts/136500_136599/13652102/10.06.00_60/ts_13652102v100600p.pdf</a>
TTA	TTAT.3G-36.521-2(R10-10.5.0)		10.5.0 Aug 13	<a href="http://www.tta.or.kr/data/ttasDown.jsp?where=14688&amp;pk_num=TTAT.3G-36.521-2(R10-10.5.0)">http://www.tta.or.kr/data/ttasDown.jsp?where=14688&amp;pk_num=TTAT.3G-36.521-2(R10-10.5.0)</a>
TTC	Not applicable			
<b>Release 11</b>				
ARIB	ARIB STD-T104-36.521-2		11.4.0 Jul 14	<a href="http://www.arib.or.jp/english/html/overview/doc/STD-T104v2_40/2_T104/ARIB-STD-T104/Rel11/36/A36521-2-b40.pdf">http://www.arib.or.jp/english/html/overview/doc/STD-T104v2_40/2_T104/ARIB-STD-T104/Rel11/36/A36521-2-b40.pdf</a>
ATIS	ATIS.3GPP.36.521-2V1140-2015		11.4.0 May 15	<a href="https://www.atis.org/docstore/default.aspx">https://www.atis.org/docstore/default.aspx</a>
CCSA	CCSA-TSD-LTE-36.521-2		11.4.0 Apr 15	<a href="http://www.ccsa.org.cn/ITU_spec/ITU-R/M.2012/M.2012-2/LTE/Rel-11/CCSA-TSD-LTE-36521-2-b40.zip">http://www.ccsa.org.cn/ITU_spec/ITU-R/M.2012/M.2012-2/LTE/Rel-11/CCSA-TSD-LTE-36521-2-b40.zip</a>
ETSI	ETSI TS 136 521-2		11.4.0 Apr 14	<a href="http://www.etsi.org/deliver/etsi_ts/136500_136599/13652102/11.04.00_60/ts_13652102v110400p.pdf">http://www.etsi.org/deliver/etsi_ts/136500_136599/13652102/11.04.00_60/ts_13652102v110400p.pdf</a>
TTA	TTAT.3G-36.521-2(R11-11.0.0)		11.0.0 Aug 13	<a href="http://www.tta.or.kr/data/ttasDown.jsp?where=14688&amp;pk_num=TTAT.3G-36.521-2(R11-11.0.0)">http://www.tta.or.kr/data/ttasDown.jsp?where=14688&amp;pk_num=TTAT.3G-36.521-2(R11-11.0.0)</a>
TTC	Not applicable			
<b>Release 12</b>				
ARIB	Not applicable			
ATIS	ATIS.3GPP.36.521-2V1240-2015		12.4.0 May 15	<a href="https://www.atis.org/docstore/default.aspx">https://www.atis.org/docstore/default.aspx</a>
CCSA	CCSA-TSD-LTE-36.521-2		12.4.0 Apr 15	<a href="http://www.ccsa.org.cn/ITU_spec/ITU-R/M.2012/M.2012-2/LTE/Rel-12/CCSA-TSD-LTE-36521-2-c40.zip">http://www.ccsa.org.cn/ITU_spec/ITU-R/M.2012/M.2012-2/LTE/Rel-12/CCSA-TSD-LTE-36521-2-c40.zip</a>
ETSI	ETSI TS 136 521-2		12.4.0 Jan 15	<a href="http://www.etsi.org/deliver/etsi_ts/136500_136599/13652102/12.04.00_60/ts_13652102v120400p.pdf">http://www.etsi.org/deliver/etsi_ts/136500_136599/13652102/12.04.00_60/ts_13652102v120400p.pdf</a>
TTA	TTAT.3G-36.521-2(R12-12.4.0)		12.4.0 Apr 15	<a href="http://www.tta.or.kr/data/ttasDown.jsp?where=14688&amp;pk_num=TTAT.3G-36.521-2(R12-12.4.0)">http://www.tta.or.kr/data/ttasDown.jsp?where=14688&amp;pk_num=TTAT.3G-36.521-2(R12-12.4.0)</a>
TTC	Not applicable			

### 1.2.1.6.5 TS 36.521-3

#### **Evolved Universal Terrestrial Radio Access (E-UTRA); User Equipment (UE) conformance specification; Radio transmission and reception; Part 3: Radio Resource Management (RRM) conformance testing**

This document specifies the measurement procedures for the conformance test of the user equipment (UE) that contain requirements for support of RRM (Radio Resource Management) as part of the 3G Long Term Evolution (3G LTE).

The requirements are listed in different clauses only if the corresponding parameters deviate. More generally, tests are only applicable to those mobiles that are intended to support the appropriate functionality. To indicate the circumstances in which tests apply, this is noted in the “test applicability” part of the test.

For example only Release 8 and later UE declared to support LTE shall be tested for this functionality. In the event that for some tests different conditions apply for different releases, this is indicated within the text of the test itself.

SDO (2)	Document No.	Version	Issued date	Location (1)
<b>Release 10</b>				

ARIB	ARIB STD-T104-36.521-3	10.4.0	Sep 13	<a href="http://www.arib.or.jp/english/html/overview/doc/STD-T104v2_10/2_T104/ARIB-STD-T104/Rel10/36/A36521-3-a40.pdf">http://www.arib.or.jp/english/html/overview/doc/STD-T104v2_10/2_T104/ARIB-STD-T104/Rel10/36/A36521-3-a40.pdf</a>
ATIS	ATIS.3GPP.36.521-3V1040-2013	10.4.0	Jun 13	<a href="https://www.atis.org/docstore/default.aspx">https://www.atis.org/docstore/default.aspx</a>
CCSA	CCSA-TSD-LTE-36.521-3	10.4.0	Apr 15	<a href="http://www.ccsa.org.cn/ITU_spec/ITU-R/M.2012/M.2012-2/LTE/Rel-10/CCSA-TSD-LTE-36521-3-a40.zip">http://www.ccsa.org.cn/ITU_spec/ITU-R/M.2012/M.2012-2/LTE/Rel-10/CCSA-TSD-LTE-36521-3-a40.zip</a>
ETSI	ETSI TS 136 521-3	10.4.0	Jul 13	<a href="http://www.etsi.org/deliver/etsi_ts/136500_136599/13652103/10.04.00_60/ts_13652103v100400p.pdf">http://www.etsi.org/deliver/etsi_ts/136500_136599/13652103/10.04.00_60/ts_13652103v100400p.pdf</a>
TTA	TTAT.3G-36.521-3(R10-10.4.0)	10.4.0	Aug 13	<a href="http://www.tta.or.kr/data/ttasDown.jsp?where=14688&amp;pk_num=TTAT.3G-36.521-3(R10-10.4.0)">http://www.tta.or.kr/data/ttasDown.jsp?where=14688&amp;pk_num=TTAT.3G-36.521-3(R10-10.4.0)</a>
TTC	Not applicable			
<b>Release 11</b>				
ARIB	ARIB STD-T104-36.521-3	11.4.0	Jul 14	<a href="http://www.arib.or.jp/english/html/overview/doc/STD-T104v2_40/2_T104/ARIB-STD-T104/Rel11/36/A36521-3-b40.pdf">http://www.arib.or.jp/english/html/overview/doc/STD-T104v2_40/2_T104/ARIB-STD-T104/Rel11/36/A36521-3-b40.pdf</a>
ATIS	ATIS.3GPP.36.521-3V1140-2015	11.4.0	May 15	<a href="https://www.atis.org/docstore/default.aspx">https://www.atis.org/docstore/default.aspx</a>
CCSA	CCSA-TSD-LTE-36.521-3	11.4.0	Apr 15	<a href="http://www.ccsa.org.cn/ITU_spec/ITU-R/M.2012/M.2012-2/LTE/Rel-11/CCSA-TSD-LTE-36521-3-b40.zip">http://www.ccsa.org.cn/ITU_spec/ITU-R/M.2012/M.2012-2/LTE/Rel-11/CCSA-TSD-LTE-36521-3-b40.zip</a>
ETSI	ETSI TS 136 521-3	11.4.0	Apr 14	<a href="http://www.etsi.org/deliver/etsi_ts/136500_136599/13652103/11.04.00_60/ts_13652103v110400p.pdf">http://www.etsi.org/deliver/etsi_ts/136500_136599/13652103/11.04.00_60/ts_13652103v110400p.pdf</a>
TTA	TTAT.3G-36.521-3(R11-11.0.0)	11.0.0	Aug 13	<a href="http://www.tta.or.kr/data/ttasDown.jsp?where=14688&amp;pk_num=TTAT.3G-36.521-3(R11-11.0.0)">http://www.tta.or.kr/data/ttasDown.jsp?where=14688&amp;pk_num=TTAT.3G-36.521-3(R11-11.0.0)</a>
TTC	Not applicable			
<b>Release 12</b>				
ARIB	Not applicable			
ATIS	ATIS.3GPP.36.521-3V1241-2015	12.4.1	May 15	<a href="https://www.atis.org/docstore/default.aspx">https://www.atis.org/docstore/default.aspx</a>
CCSA	CCSA-TSD-LTE-36.521-3	12.4.1	Apr 15	<a href="http://www.ccsa.org.cn/ITU_spec/ITU-R/M.2012/M.2012-2/LTE/Rel-12/CCSA-TSD-LTE-36521-3-c41.zip">http://www.ccsa.org.cn/ITU_spec/ITU-R/M.2012/M.2012-2/LTE/Rel-12/CCSA-TSD-LTE-36521-3-c41.zip</a>
ETSI	ETSI TS 136 521-3	12.4.1		
TTA	TTAT.3G-36.521-3(R12-12.4.1)	12.4.1	Apr 15	<a href="http://www.tta.or.kr/data/ttasDown.jsp?where=14688&amp;pk_num=TTAT.3G-36.521-3(R12-12.4.1)">http://www.tta.or.kr/data/ttasDown.jsp?where=14688&amp;pk_num=TTAT.3G-36.521-3(R12-12.4.1)</a>
TTC	Not applicable			

### 1.2.1.6.6 TS 36.523-1

#### Evolved Universal Terrestrial Radio Access (E-UTRA) and Evolved Packet Core (EPC); User Equipment (UE) conformance specification; Part 1: Protocol conformance specification

This document specifies the protocol conformance testing for the 3<sup>rd</sup> Generation E-UTRAN User Equipment (UE).

This is the first part of a multi-part test specification. The following information can be found in this part:

- the overall test structure;
- the test configurations;
- the conformance requirement and reference to the core specifications;
- the test purposes; and
- a brief description of the test procedure, the specific test requirements and short message exchange table.

The following information relevant to testing could be found in accompanying specifications:

- the default setting of the test parameters (TS 36.508);
- the applicability of each test case (TS 36.523-2).

A detailed description of the expected sequence of messages could be found in the 3<sup>rd</sup> part of this test specification.

The Implementation Conformance Statement (ICS) pro-forma could be found in the 2<sup>nd</sup> part of this document.

This document is valid for UE implemented according to 3GPP releases starting from Release 8 up to the Release indicated on the cover page of this document.

SDO (2)	Document No.	Version	Issued date		Location (1)
<b>Release 10</b>					
ARIB	ARIB STD-T104-36.523-1		10.3.1	Sep 13	<a href="http://www.arib.or.jp/english/html/overview/doc/STD-T104v2_10/2_T104/ARIB-STD-T104/Rel10/36/A36523-1-a31.pdf">http://www.arib.or.jp/english/html/overview/doc/STD-T104v2_10/2_T104/ARIB-STD-T104/Rel10/36/A36523-1-a31.pdf</a>
ATIS	ATIS.3GPP.36.523-1V1031-2013		10.3.1	Jun 13	<a href="https://www.atis.org/docstore/default.aspx">https://www.atis.org/docstore/default.aspx</a>
CCSA	CCSA-TSD-LTE-36.523-1		10.3.1	Apr 15	<a href="http://www.ccsa.org.cn/ITU_spec/ITU-R/M.2012/M.2012-2/LTE/Rel-10/CCSA-TSD-LTE-36523-1-a31.zip">http://www.ccsa.org.cn/ITU_spec/ITU-R/M.2012/M.2012-2/LTE/Rel-10/CCSA-TSD-LTE-36523-1-a31.zip</a>
ETSI	ETSI TS 136 523-1		10.3.1	Feb 13	<a href="http://www.etsi.org/deliver/etsi_ts/136500_136599/13652301/10.03.01_60/ts_13652301v100301p.pdf">http://www.etsi.org/deliver/etsi_ts/136500_136599/13652301/10.03.01_60/ts_13652301v100301p.pdf</a>
TTA	TTAT.3G-36.523-1(R10-10.3.1)		10.3.1	Aug 13	<a href="http://www.tta.or.kr/data/ttasDown.jsp?where=14688&amp;pk_num=TTAT.3G-36.523-1(R10-10.3.1)">http://www.tta.or.kr/data/ttasDown.jsp?where=14688&amp;pk_num=TTAT.3G-36.523-1(R10-10.3.1)</a>
TTC	Not applicable				
<b>Release 11</b>					
ARIB	ARIB STD-T104-36.523-1		11.6.0	Jul 14	<a href="http://www.arib.or.jp/english/html/overview/doc/STD-T104v2_40/2_T104/ARIB-STD-T104/Rel11/36/A36523-1-b60.pdf">http://www.arib.or.jp/english/html/overview/doc/STD-T104v2_40/2_T104/ARIB-STD-T104/Rel11/36/A36523-1-b60.pdf</a>
ATIS	ATIS.3GPP.36.523-1V1160-2015		11.6.0	May 15	<a href="https://www.atis.org/docstore/default.aspx">https://www.atis.org/docstore/default.aspx</a>
CCSA	CCSA-TSD-LTE-36.523-1		11.6.0	Apr 15	<a href="http://www.ccsa.org.cn/ITU_spec/ITU-R/M.2012/M.2012-2/LTE/Rel-11/CCSA-TSD-LTE-36523-1-b60.zip">http://www.ccsa.org.cn/ITU_spec/ITU-R/M.2012/M.2012-2/LTE/Rel-11/CCSA-TSD-LTE-36523-1-b60.zip</a>
ETSI	ETSI TS 136 523-1		11.6.0	Apr 14	<a href="http://www.etsi.org/deliver/etsi_ts/136500_136599/13652301/11.06.00_60/ts_13652301v110600p.pdf">http://www.etsi.org/deliver/etsi_ts/136500_136599/13652301/11.06.00_60/ts_13652301v110600p.pdf</a>
TTA	TTAT.3G-36.523-1(R11-11.2.0)		11.2.0	Aug 13	<a href="http://www.tta.or.kr/data/ttasDown.jsp?where=14688&amp;pk_num=TTAT.3G-36.523-1(R11-11.2.0)">http://www.tta.or.kr/data/ttasDown.jsp?where=14688&amp;pk_num=TTAT.3G-36.523-1(R11-11.2.0)</a>
TTC	Not applicable				
<b>Release 12</b>					
ARIB	Not applicable				
ATIS	ATIS.3GPP.36.523-1V1240-2015		12.4.0	May 15	<a href="https://www.atis.org/docstore/default.aspx">https://www.atis.org/docstore/default.aspx</a>
CCSA	CCSA-TSD-LTE-36.523-1		12.4.0	Apr 15	<a href="http://www.ccsa.org.cn/ITU_spec/ITU-R/M.2012/M.2012-2/LTE/Rel-12/CCSA-TSD-LTE-36523-1-c40.zip">http://www.ccsa.org.cn/ITU_spec/ITU-R/M.2012/M.2012-2/LTE/Rel-12/CCSA-TSD-LTE-36523-1-c40.zip</a>
ETSI	ETSI TS 136 523-1		12.4.0	Apr 15	<a href="http://www.etsi.org/deliver/etsi_ts/136500_136599/13652301/12.04.00_60/ts_13652301v120400p.pdf">http://www.etsi.org/deliver/etsi_ts/136500_136599/13652301/12.04.00_60/ts_13652301v120400p.pdf</a>
TTA	TTAT.3G-36.523-1(R12-12.4.0)		12.4.0	Apr 15	<a href="http://www.tta.or.kr/data/ttasDown.jsp?where=14688&amp;pk_num=TTAT.3G-36.523-1(R12-12.4.0)">http://www.tta.or.kr/data/ttasDown.jsp?where=14688&amp;pk_num=TTAT.3G-36.523-1(R12-12.4.0)</a>
TTC	Not applicable				

### 1.2.1.6.7 TS 36.523-2

#### Evolved Universal Terrestrial Radio Access (E-UTRA) and Evolved Packet Core (EPC); User Equipment (UE) conformance specification; Part 2: Implementation Conformance Statement (ICS) proforma specification

This document provides the ICS proforma for 3<sup>rd</sup> Generation User Equipment (UE), in compliance with the relevant EPS (E-UTRA/EPC) requirements, and in accordance with the relevant guidance given in ISO/IEC 9646-1 and ISO/IEC 9646-7.

This document also specifies a recommended applicability statement for the test cases included in TS 36.523-1. These applicability statements are based on the features implemented in the UE.

Special conformance testing functions can be found in TS 36.509 and the common test environments are included in 3GPP TS 36.508.

This document is valid for UE complying with EPS (E-UTRA/EPC) and implemented according to 3GPP releases starting from Release 8 up to the Release indicated on the cover page of this document.

SDO (2)	Document No.	Version	Issued date	Location (1)
<b>Release 10</b>				
ARIB	ARIB STD-T104-36.523-2		10.3.0 Sep 13	<a href="http://www.arib.or.jp/english/html/overview/doc/STD-T104v2_10/2_T104/ARIB-STD-T104/Rel10/36/A36523-2-a30.pdf">http://www.arib.or.jp/english/html/overview/doc/STD-T104v2_10/2_T104/ARIB-STD-T104/Rel10/36/A36523-2-a30.pdf</a>
ATIS	ATIS.3GPP.36.523-2V1030-2013		10.3.0 Jun 13	<a href="https://www.atis.org/docstore/default.aspx">https://www.atis.org/docstore/default.aspx</a>
CCSA	CCSA-TSD-LTE-36.523-2		10.3.0 Apr 15	<a href="http://www.ccsa.org.cn/ITU_spec/ITU-R/M.2012/M.2012-2/LTE/Rel-10/CCSA-TSD-LTE-36523-2-a30.zip">http://www.ccsa.org.cn/ITU_spec/ITU-R/M.2012/M.2012-2/LTE/Rel-10/CCSA-TSD-LTE-36523-2-a30.zip</a>
ETSI	ETSI TS 136 523-2		10.3.0 Jan 13	<a href="http://www.etsi.org/deliver/etsi_ts/136500_136599/13652302/10.03.00_60/ts_13652302v100300p.pdf">http://www.etsi.org/deliver/etsi_ts/136500_136599/13652302/10.03.00_60/ts_13652302v100300p.pdf</a>
TTA	TTAT.3G-36.523-2(R10-10.3.0)		10.3.0 Aug 13	<a href="http://www.tta.or.kr/data/ttasDown.jsp?where=14688&amp;pk_num=TTAT.3G-36.523-2(R10-10.3.0)">http://www.tta.or.kr/data/ttasDown.jsp?where=14688&amp;pk_num=TTAT.3G-36.523-2(R10-10.3.0)</a>
TTC	Not applicable			
<b>Release 11</b>				
ARIB	ARIB STD-T104-36.523-2		11.6.0 Jul 14	<a href="http://www.arib.or.jp/english/html/overview/doc/STD-T104v2_40/2_T104/ARIB-STD-T104/Rel11/36/A36523-2-b60.pdf">http://www.arib.or.jp/english/html/overview/doc/STD-T104v2_40/2_T104/ARIB-STD-T104/Rel11/36/A36523-2-b60.pdf</a>
ATIS	ATIS.3GPP.36.523-2V1160-2015		11.6.0 May 15	<a href="https://www.atis.org/docstore/default.aspx">https://www.atis.org/docstore/default.aspx</a>
CCSA	CCSA-TSD-LTE-36.523-2		11.6.0 Apr 15	<a href="http://www.ccsa.org.cn/ITU_spec/ITU-R/M.2012/M.2012-2/LTE/Rel-11/CCSA-TSD-LTE-36523-2-b60.zip">http://www.ccsa.org.cn/ITU_spec/ITU-R/M.2012/M.2012-2/LTE/Rel-11/CCSA-TSD-LTE-36523-2-b60.zip</a>
ETSI	ETSI TS 136 523-2		11.6.0 Apr 14	<a href="http://www.etsi.org/deliver/etsi_ts/136500_136599/13652302/11.06.00_60/ts_13652302v110600p.pdf">http://www.etsi.org/deliver/etsi_ts/136500_136599/13652302/11.06.00_60/ts_13652302v110600p.pdf</a>
TTA	TTAT.3G-36.523-2(R11-11.2.2)		11.2.2 Aug 13	<a href="http://www.tta.or.kr/data/ttasDown.jsp?where=14688&amp;pk_num=TTAT.3G-36.523-2(R11-11.2.2)">http://www.tta.or.kr/data/ttasDown.jsp?where=14688&amp;pk_num=TTAT.3G-36.523-2(R11-11.2.2)</a>
TTC	Not applicable			
<b>Release 12</b>				
ARIB	Not applicable			
ATIS	ATIS.3GPP.36.523-2V1240-2015		12.4.0 May 15	<a href="https://www.atis.org/docstore/default.aspx">https://www.atis.org/docstore/default.aspx</a>
CCSA	CCSA-TSD-LTE-36.523-2		12.4.0 Apr 15	<a href="http://www.ccsa.org.cn/ITU_spec/ITU-R/M.2012/M.2012-2/LTE/Rel-12/CCSA-TSD-LTE-36523-2-c40.zip">http://www.ccsa.org.cn/ITU_spec/ITU-R/M.2012/M.2012-2/LTE/Rel-12/CCSA-TSD-LTE-36523-2-c40.zip</a>
ETSI	ETSI TS 136 523-2		12.4.0 Jan 15	<a href="http://www.etsi.org/deliver/etsi_ts/136500_136599/13652302/12.04.00_60/ts_13652302v120400p.pdf">http://www.etsi.org/deliver/etsi_ts/136500_136599/13652302/12.04.00_60/ts_13652302v120400p.pdf</a>
TTA	TTAT.3G-36.523-2(R12-12.4.0)		12.4.0 Apr 15	<a href="http://www.tta.or.kr/data/ttasDown.jsp?where=14688&amp;pk_num=TTAT.3G-36.523-2(R12-12.4.0)">http://www.tta.or.kr/data/ttasDown.jsp?where=14688&amp;pk_num=TTAT.3G-36.523-2(R12-12.4.0)</a>
TTC	Not applicable			

### 1.2.1.6.8 TS 36.523-3

#### Evolved Universal Terrestrial Radio Access (E-UTRA) and Evolved Packet Core (EPC); User Equipment (UE) conformance specification; Part 3: Test suites

This document specifies the protocol and signalling conformance testing in TTCN-3 for the 3GPP UE at the UE-E-UTRAN radio interface.

The following TTCN test specification and design considerations can be found in this document:

- the test system architecture;
- the overall test suite structure;
- the test models and ASP definitions;
- the test methods and usage of communication ports definitions;
- the test configurations;
- the design principles and assumptions;
- TTCN styles and conventions;
- the partial PIXIT proforma;

– the test suites.

The Abstract Test Suites designed in the document are based on the test cases specified in prose (3GPP TS 36.523-1). The applicability of the individual test cases is specified in the test ICS proforma specification (3GPP TS 36.523-2).

This document is valid for UE implemented according to 3GPP Rel-9 upwards.

SDO (2)	Document No.	Version	Issued date	Location (1)
<b>Release 10</b>				
ARIB	ARIB STD-T104-36.523-3	10.5.1	Mar 14	<a href="http://www.arib.or.jp/english/html/overview/doc/STD-T104v2_30/2_T104/ARIB-STD-T104/Rel10/36/A36523-3-a51.pdf">http://www.arib.or.jp/english/html/overview/doc/STD-T104v2_30/2_T104/ARIB-STD-T104/Rel10/36/A36523-3-a51.pdf</a>
ATIS	ATIS.3GPP.36.523-3V1051-2015	10.5.1	May 15	<a href="https://www.atis.org/docstore/default.aspx">https://www.atis.org/docstore/default.aspx</a>
CCSA	CCSA-TSD-LTE-36.523-3	10.5.1	Apr 15	<a href="http://www.ccsa.org.cn/ITU_spec/ITU-R/M.2012/M.2012-2/LTE/Rel-10/CCSA-TSD-LTE-36523-3-a51.zip">http://www.ccsa.org.cn/ITU_spec/ITU-R/M.2012/M.2012-2/LTE/Rel-10/CCSA-TSD-LTE-36523-3-a51.zip</a>
ETSI	ETSI TS 136 523-3	10.5.1	Oct 13	<a href="http://www.etsi.org/deliver/etsi_ts/136500_136599/13652303/10.05.01_60/ts_13652303v100501p.pdf">http://www.etsi.org/deliver/etsi_ts/136500_136599/13652303/10.05.01_60/ts_13652303v100501p.pdf</a>
TTA	TTAT.3G-36.523-3(R10-10.3.0)	10.3.0	Aug 13	<a href="http://www.tta.or.kr/data/ttasDown.jsp?where=14688&amp;pk_num=TTAT.3G-36.523-3(R10-10.3.0)">http://www.tta.or.kr/data/ttasDown.jsp?where=14688&amp;pk_num=TTAT.3G-36.523-3(R10-10.3.0)</a>
TTC	Not applicable			
<b>Release 11</b>				
ARIB	ARIB STD-T104-36.523-3	11.6.0	Mar 15	<a href="http://www.arib.or.jp/english/html/overview/doc/STD-T104v2_70/2_T104/ARIB-STD-T104/Rel11/36/A36523-3-b60.pdf">http://www.arib.or.jp/english/html/overview/doc/STD-T104v2_70/2_T104/ARIB-STD-T104/Rel11/36/A36523-3-b60.pdf</a>
ATIS	ATIS.3GPP.36.523-3V1160-2015	11.6.0	May 15	<a href="https://www.atis.org/docstore/default.aspx">https://www.atis.org/docstore/default.aspx</a>
CCSA	CCSA-TSD-LTE-36.523-3	11.6.0	Apr 15	<a href="http://www.ccsa.org.cn/ITU_spec/ITU-R/M.2012/M.2012-2/LTE/Rel-11/CCSA-TSD-LTE-36523-3-a60.zip">http://www.ccsa.org.cn/ITU_spec/ITU-R/M.2012/M.2012-2/LTE/Rel-11/CCSA-TSD-LTE-36523-3-a60.zip</a>
ETSI	ETSI TS 136 523-3	11.6.0	Apr 15	<a href="http://www.etsi.org/deliver/etsi_ts/136500_136599/13652303/11.06.00_60/ts_13652303v110600p.pdf">http://www.etsi.org/deliver/etsi_ts/136500_136599/13652303/11.06.00_60/ts_13652303v110600p.pdf</a>
TTA	TTAT.3G-36.523-3(R11-11.6.0)	11.6.0	Apr 15	<a href="http://www.tta.or.kr/data/ttasDown.jsp?where=14688&amp;pk_num=TTAT.3G-36.523-3(R11-11.6.0)">http://www.tta.or.kr/data/ttasDown.jsp?where=14688&amp;pk_num=TTAT.3G-36.523-3(R11-11.6.0)</a>
TTC	Not applicable			
<b>Release 12</b>				
ARIB	Not applicable			
ATIS	ATIS.3GPP.36.523-3V1200-2015	12.0.0	May 15	<a href="https://www.atis.org/docstore/default.aspx">https://www.atis.org/docstore/default.aspx</a>
CCSA	CCSA-TSD-LTE-36.523-3	12.0.0	Apr 15	<a href="http://www.ccsa.org.cn/ITU_spec/ITU-R/M.2012/M.2012-2/LTE/Rel-12/CCSA-TSD-LTE-36523-3-c00.zip">http://www.ccsa.org.cn/ITU_spec/ITU-R/M.2012/M.2012-2/LTE/Rel-12/CCSA-TSD-LTE-36523-3-c00.zip</a>
ETSI	ETSI TS 136 523-3	12.0.0	Mar 15	<a href="http://www.etsi.org/deliver/etsi_ts/136500_136599/13652303/12.00.00_60/ts_13652303v120000p.pdf">http://www.etsi.org/deliver/etsi_ts/136500_136599/13652303/12.00.00_60/ts_13652303v120000p.pdf</a>
TTA	TTAT.3G-36.523-3(R12-12.0.0)	12.0.0	Apr 15	<a href="http://www.tta.or.kr/data/ttasDown.jsp?where=14688&amp;pk_num=TTAT.3G-36.523-3(R12-12.0.0)">http://www.tta.or.kr/data/ttasDown.jsp?where=14688&amp;pk_num=TTAT.3G-36.523-3(R12-12.0.0)</a>
TTC	Not applicable			

### 1.2.1.6.9 TS 37.571-1

#### Universal Terrestrial Radio Access (UTRA) and Evolved UTRA (E-UTRA) and Evolved Packet Core (EPC); User Equipment (UE) conformance specification for UE positioning; Part 1: Conformance test specification

This document specifies the procedures for the conformance test of the measurement requirements for FDD mode of UTRA and FDD or TDD mode of E-UTRA for the User Equipment (UE) that supports one or more of the defined positioning methods. These positioning methods are for UTRA: Assisted Global Positioning System (A-GPS), Assisted Global Navigation Satellite Systems (A-GNSS) and for E-UTRA: Assisted Global Navigation Satellite System (A-GNSS), Observed Time Difference of Arrival (OTDOA), Enhanced Cell ID (ECID).

Tests are only applicable to those mobiles that are intended to support the appropriate functionality. To indicate the circumstances in which tests apply, this is noted in the “Test applicability” part of the test.



The Implementation Conformance Statement (ICS) pro-forma could be found in the 3<sup>rd</sup> part of this document.

SDO (2)	Document No.	Version	Issued date	Location (1)
<b>Release 10</b>				
ARIB	ARIB STD-T104-37.571-1		10.7.0 Jul 14	<a href="http://www.arib.or.jp/english/html/overview/doc/STD-T104v2_40/2_T104/ARIB-STD-T104/Rel10/37/A37571-1-a70.pdf">http://www.arib.or.jp/english/html/overview/doc/STD-T104v2_40/2_T104/ARIB-STD-T104/Rel10/37/A37571-1-a70.pdf</a>
ATIS	ATIS.3GPP.37.571-1V1070-2015		10.7.0 May 15	<a href="https://www.atis.org/docstore/default.aspx">https://www.atis.org/docstore/default.aspx</a>
CCSA	CCSA-TSD-LTE-37.571-1		10.7.0 Apr 15	<a href="http://www.ccsa.org.cn/ITU_spec/ITU-R/M.2012/M.2012-2/LTE/Rel-10/CCSA-TSD-LTE-37571-1-a70.zip">http://www.ccsa.org.cn/ITU_spec/ITU-R/M.2012/M.2012-2/LTE/Rel-10/CCSA-TSD-LTE-37571-1-a70.zip</a>
ETSI	ETSI TS 137 571-1		10.7.0 Mar 14	<a href="http://www.etsi.org/deliver/etsi_ts/137500_137599/13757101/10.07.00_60/ts_13757101v100700p.pdf">http://www.etsi.org/deliver/etsi_ts/137500_137599/13757101/10.07.00_60/ts_13757101v100700p.pdf</a>
TTA	TTAT.3G-37.571-1(R10-10.3.0)		10.3.0 Aug 13	<a href="http://www.tta.or.kr/data/ttasDown.jsp?where=14688&amp;pk_num=TTAT.3G-37.571-1(R10-10.3.0)">http://www.tta.or.kr/data/ttasDown.jsp?where=14688&amp;pk_num=TTAT.3G-37.571-1(R10-10.3.0)</a>
TTC	Not applicable			
<b>Release 11</b>				
ARIB	ARIB STD-T104-37.571-1		11.2.0 Dec 14	<a href="http://www.arib.or.jp/english/html/overview/doc/STD-T104v2_60/2_T104/ARIB-STD-T104/Rel11/37/A37571-1-b20.pdf">http://www.arib.or.jp/english/html/overview/doc/STD-T104v2_60/2_T104/ARIB-STD-T104/Rel11/37/A37571-1-b20.pdf</a>
ATIS	ATIS.3GPP.37.571-1V1120-2015		11.2.0 May 15	<a href="https://www.atis.org/docstore/default.aspx">https://www.atis.org/docstore/default.aspx</a>
CCSA	CCSA-TSD-LTE-37.571-1		11.2.0 Apr 15	<a href="http://www.ccsa.org.cn/ITU_spec/ITU-R/M.2012/M.2012-2/LTE/Rel-11/CCSA-TSD-LTE-37571-1-b20.zip">http://www.ccsa.org.cn/ITU_spec/ITU-R/M.2012/M.2012-2/LTE/Rel-11/CCSA-TSD-LTE-37571-1-b20.zip</a>
ETSI	ETSI TS 137 571-1		11.2.0 Oct 14	<a href="http://www.etsi.org/deliver/etsi_ts/137500_137599/13757101/11.02.00_60/ts_13757101v110200p.pdf">http://www.etsi.org/deliver/etsi_ts/137500_137599/13757101/11.02.00_60/ts_13757101v110200p.pdf</a>
TTA	TTAT.3G-37.571-1(R11-11.2.0)		11.2.0 Apr 15	<a href="http://www.tta.or.kr/data/ttasDown.jsp?where=14688&amp;pk_num=TTAT.3G-37.571-1(R11-11.2.0)">http://www.tta.or.kr/data/ttasDown.jsp?where=14688&amp;pk_num=TTAT.3G-37.571-1(R11-11.2.0)</a>
TTC	Not applicable			
<b>Release 12</b>				
ARIB	Not applicable			
ATIS	ATIS.3GPP.37.571-1V1210-2015		12.1.0 May 15	<a href="https://www.atis.org/docstore/default.aspx">https://www.atis.org/docstore/default.aspx</a>
CCSA	CCSA-TSD-LTE-37.571-1		12.1.0 Apr 15	<a href="http://www.ccsa.org.cn/ITU_spec/ITU-R/M.2012/M.2012-2/LTE/Rel-12/CCSA-TSD-LTE-37571-1-c10.zip">http://www.ccsa.org.cn/ITU_spec/ITU-R/M.2012/M.2012-2/LTE/Rel-12/CCSA-TSD-LTE-37571-1-c10.zip</a>
ETSI	ETSI TS 137 571-1		12.1.0 Jan 15	<a href="http://www.etsi.org/deliver/etsi_ts/137500_137599/13757101/12.01.00_60/ts_13757101v120100p.pdf">http://www.etsi.org/deliver/etsi_ts/137500_137599/13757101/12.01.00_60/ts_13757101v120100p.pdf</a>
TTA	TTAT.3G-37.571-1(R12-12.1.0)		12.1.0 Apr 15	<a href="http://www.tta.or.kr/data/ttasDown.jsp?where=14688&amp;pk_num=TTAT.3G-37.571-1(R12-12.1.0)">http://www.tta.or.kr/data/ttasDown.jsp?where=14688&amp;pk_num=TTAT.3G-37.571-1(R12-12.1.0)</a>
TTC	Not applicable			

### 1.2.1.6.10 TS 37.571-2

#### Universal Terrestrial Radio Access (UTRA) and Evolved UTRA (E-UTRA) and Evolved Packet Core (EPC); User Equipment (UE) conformance specification for UE positioning; Part 2: Protocol conformance

This document specifies the protocol conformance testing for the 3<sup>rd</sup> Generation UTRAN and E-UTRAN User Equipment (UE) supporting UE positioning.

This is the second part of a multi-part test specification. The following information can be found in this part:

- the overall protocol conformance test structure;
- the protocol conformance test configurations;
- the conformance requirement and reference to the core specifications;
- the test purposes; and
- a brief description of the test procedure, the specific test requirements and short message exchange table.

The Implementation Conformance Statement (ICS) pro-forma could be found in the 3<sup>rd</sup> part of this document.

This document is valid for UE supporting UE positioning implemented according to 3GPP releases starting from Release 99 up to the Release indicated on the cover page of this document.

SDO (2)	Document No.	Version	Issued date	Location (1)
<b>Release 10</b>				
ARIB	ARIB STD-T104-37.571-2		10.9.0 Mar 15	<a href="http://www.arib.or.jp/english/html/overview/doc/STD-T104v2_70/2_T104/ARIB-STD-T104/Rel10/37/A37571-2-a90.pdf">http://www.arib.or.jp/english/html/overview/doc/STD-T104v2_70/2_T104/ARIB-STD-T104/Rel10/37/A37571-2-a90.pdf</a>
ATIS	ATIS.3GPP.37.571-2V1090-2015		10.9.0 May 15	<a href="https://www.atis.org/docstore/default.aspx">https://www.atis.org/docstore/default.aspx</a>
CCSA	CCSA-TSD-LTE-37.571-2		10.9.0 Apr 15	<a href="http://www.ccsa.org.cn/ITU_spec/ITU-R/M.2012/M.2012-2/LTE/Rel-10/CCSA-TSD-LTE-37571-2-a90.zip">http://www.ccsa.org.cn/ITU_spec/ITU-R/M.2012/M.2012-2/LTE/Rel-10/CCSA-TSD-LTE-37571-2-a90.zip</a>
ETSI	ETSI TS 137 571-2		10.9.0 Jan 15	<a href="http://www.etsi.org/deliver/etsi_ts/137500_137599/13757102/10.09.00_60/ts_13757102v100900p.pdf">http://www.etsi.org/deliver/etsi_ts/137500_137599/13757102/10.09.00_60/ts_13757102v100900p.pdf</a>
TTA	TTAT.3G-37.571-2(R10-10.2.0)		10.2.0 Aug 13	<a href="http://www.tta.or.kr/data/ttasDown.jsp?where=14688&amp;pk_num=TTAT.3G-37.571-2(R10-10.2.0)">http://www.tta.or.kr/data/ttasDown.jsp?where=14688&amp;pk_num=TTAT.3G-37.571-2(R10-10.2.0)</a>
TTC	Not applicable			
<b>Release 11</b>				
ARIB	ARIB STD-T104-37.571-2		11.0.0 Mar 15	<a href="http://www.arib.or.jp/english/html/overview/doc/STD-T104v2_70/2_T104/ARIB-STD-T104/Rel11/37/A37571-2-b00.pdf">http://www.arib.or.jp/english/html/overview/doc/STD-T104v2_70/2_T104/ARIB-STD-T104/Rel11/37/A37571-2-b00.pdf</a>
ATIS	ATIS.3GPP.37.571-2V1100-2015		11.0.0 May 15	<a href="https://www.atis.org/docstore/default.aspx">https://www.atis.org/docstore/default.aspx</a>
CCSA	CCSA-TSD-LTE-37.571-2		11.0.0 Apr 15	<a href="http://www.ccsa.org.cn/ITU_spec/ITU-R/M.2012/M.2012-2/LTE/Rel-11/CCSA-TSD-LTE-37571-2-b00.zip">http://www.ccsa.org.cn/ITU_spec/ITU-R/M.2012/M.2012-2/LTE/Rel-11/CCSA-TSD-LTE-37571-2-b00.zip</a>
ETSI	ETSI TS 137 571-2		11.0.0 Jan 15	<a href="http://www.etsi.org/deliver/etsi_ts/137500_137599/13757102/11.00.00_60/ts_13757102v110000p.pdf">http://www.etsi.org/deliver/etsi_ts/137500_137599/13757102/11.00.00_60/ts_13757102v110000p.pdf</a>
TTA	TTAT.3G-37.571-2(R11-11.0.0)		11.0.0 Apr 15	<a href="http://www.tta.or.kr/data/ttasDown.jsp?where=14688&amp;pk_num=TTAT.3G-37.571-2(R11-11.0.0)">http://www.tta.or.kr/data/ttasDown.jsp?where=14688&amp;pk_num=TTAT.3G-37.571-2(R11-11.0.0)</a>
TTC	Not applicable			
<b>Release 12</b>				
ARIB	Not applicable			
ATIS	ATIS.3GPP.37.571-2V1200-2015		12.0.0 May 15	<a href="https://www.atis.org/docstore/default.aspx">https://www.atis.org/docstore/default.aspx</a>
CCSA	CCSA-TSD-LTE-37.571-2		12.0.0 Apr 15	<a href="http://www.ccsa.org.cn/ITU_spec/ITU-R/M.2012/M.2012-2/LTE/Rel-12/CCSA-TSD-LTE-37571-2-c00.zip">http://www.ccsa.org.cn/ITU_spec/ITU-R/M.2012/M.2012-2/LTE/Rel-12/CCSA-TSD-LTE-37571-2-c00.zip</a>
ETSI	ETSI TS 137 571-2		12.0.0 Jan 15	<a href="http://www.etsi.org/deliver/etsi_ts/137500_137599/13757102/12.00.00_60/ts_13757102v120000p.pdf">http://www.etsi.org/deliver/etsi_ts/137500_137599/13757102/12.00.00_60/ts_13757102v120000p.pdf</a>
TTA	TTAT.3G-37.571-2(R12-12.0.0)		12.0.0 Apr 15	<a href="http://www.tta.or.kr/data/ttasDown.jsp?where=14688&amp;pk_num=TTAT.3G-37.571-2(R12-12.0.0)">http://www.tta.or.kr/data/ttasDown.jsp?where=14688&amp;pk_num=TTAT.3G-37.571-2(R12-12.0.0)</a>
TTC	Not applicable			

### 1.2.1.6.11 TS 37.571-3

#### Universal Terrestrial Radio Access (UTRA) and Evolved UTRA (E-UTRA) and Evolved Packet Core (EPC); User Equipment (UE) conformance specification for UE positioning; Part 3: Implementation Conformance Statement (ICS)

This document provides the ICS proforma for 3<sup>rd</sup> Generation UTRAN and E-UTRAN User Equipment (UE) supporting UE positioning, in compliance with the relevant requirements, and in accordance with the relevant guidance given in ISO/IEC 9646-1 and ISO/IEC 9646-7.

This document also specifies a recommended applicability statement for the test cases included in 3GPP TS 37.571-1 and 3GPP TS 37.571-2. These applicability statements are based on the features implemented in the UE.

Special conformance testing functions can be found in 3GPP TS 34.109 for UTRA and 3GPP TS 36.509 for E-UTRA. The common test environments are included in 3GPP TS 34.108 for UTRA and in 3GPP TS 36.508 for E-UTRA.

This document is valid for UE supporting UE positioning implemented according to 3GPP releases starting from Release 99 up to the Release indicated on the cover page of this document.

SDO (2)	Document No.	Version	Issued date	Location (1)
<b>Release 10</b>				
ARIB	ARIB STD-T104-37.571-3		10.7.0 Oct 14	<a href="http://www.arib.or.jp/english/html/overview/doc/STD-T104v2_50/2_T104/ARIB-STD-T104/Rel10/37/A37571-3-a70.pdf">http://www.arib.or.jp/english/html/overview/doc/STD-T104v2_50/2_T104/ARIB-STD-T104/Rel10/37/A37571-3-a70.pdf</a>
ATIS	ATIS.3GPP.37.571-3V1070-2015		10.7.0 May 15	<a href="https://www.atis.org/docstore/default.aspx">https://www.atis.org/docstore/default.aspx</a>
CCSA	CCSA-TSD-LTE-37.571-3		10.7.0 Apr 15	<a href="http://www.ccsa.org.cn/ITU_spec/ITU-R/M.2012/M.2012-2/LTE/Rel-10/CCSA-TSD-LTE-37571-3-a70.zip">http://www.ccsa.org.cn/ITU_spec/ITU-R/M.2012/M.2012-2/LTE/Rel-10/CCSA-TSD-LTE-37571-3-a70.zip</a>
ETSI	ETSI TS 137 571-3		10.7.0 Jul 14	<a href="http://www.etsi.org/deliver/etsi_ts/137500_137599/13757103/10.07.00_60/ts_13757103v100700p.pdf">http://www.etsi.org/deliver/etsi_ts/137500_137599/13757103/10.07.00_60/ts_13757103v100700p.pdf</a>
TTA	TTAT.3G-37.571-3(R10-10.3.1)		10.3.1 Aug 13	<a href="http://www.tta.or.kr/data/ttasDown.jsp?where=14688&amp;pk_num=TTAT.3G-37.571-3(R10-10.3.1)">http://www.tta.or.kr/data/ttasDown.jsp?where=14688&amp;pk_num=TTAT.3G-37.571-3(R10-10.3.1)</a>
TTC	Not applicable			
<b>Release 11</b>				
ARIB	ARIB STD-T104-37.571-3		11.0.0 Dec 14	<a href="http://www.arib.or.jp/english/html/overview/doc/STD-T104v2_60/2_T104/ARIB-STD-T104/Rel11/37/A37571-3-b00.pdf">http://www.arib.or.jp/english/html/overview/doc/STD-T104v2_60/2_T104/ARIB-STD-T104/Rel11/37/A37571-3-b00.pdf</a>
ATIS	ATIS.3GPP.37.571-3V1100-2015		11.0.0 May 15	<a href="https://www.atis.org/docstore/default.aspx">https://www.atis.org/docstore/default.aspx</a>
CCSA	CCSA-TSD-LTE-37.571-3		11.0.0 Apr 15	<a href="http://www.ccsa.org.cn/ITU_spec/ITU-R/M.2012/M.2012-2/LTE/Rel-11/CCSA-TSD-LTE-37571-3-b00.zip">http://www.ccsa.org.cn/ITU_spec/ITU-R/M.2012/M.2012-2/LTE/Rel-11/CCSA-TSD-LTE-37571-3-b00.zip</a>
ETSI	ETSI TS 137 571-3		11.0.0 Sep 14	<a href="http://www.etsi.org/deliver/etsi_ts/137500_137599/13757103/11.00.00_60/ts_13757103v110000p.pdf">http://www.etsi.org/deliver/etsi_ts/137500_137599/13757103/11.00.00_60/ts_13757103v110000p.pdf</a>
TTA	TTAT.3G-37.571-3(R11-11.0.0)		11.0.0 Apr 15	<a href="http://www.tta.or.kr/data/ttasDown.jsp?where=14688&amp;pk_num=TTAT.3G-37.571-3(R11-11.0.0)">http://www.tta.or.kr/data/ttasDown.jsp?where=14688&amp;pk_num=TTAT.3G-37.571-3(R11-11.0.0)</a>
TTC	Not applicable			
<b>Release 12</b>				
ARIB	Not applicable			
ATIS	ATIS.3GPP.37.571-3V1210-2015		12.1.0 May 15	<a href="https://www.atis.org/docstore/default.aspx">https://www.atis.org/docstore/default.aspx</a>
CCSA	CCSA-TSD-LTE-37.571-3		12.1.0 Apr 15	<a href="http://www.ccsa.org.cn/ITU_spec/ITU-R/M.2012/M.2012-2/LTE/Rel-12/CCSA-TSD-LTE-37571-3-c10.zip">http://www.ccsa.org.cn/ITU_spec/ITU-R/M.2012/M.2012-2/LTE/Rel-12/CCSA-TSD-LTE-37571-3-c10.zip</a>
ETSI	ETSI TS 137 571-3		12.1.0 Jan 15	<a href="http://www.etsi.org/deliver/etsi_ts/137500_137599/13757103/12.01.00_60/ts_13757103v120100p.pdf">http://www.etsi.org/deliver/etsi_ts/137500_137599/13757103/12.01.00_60/ts_13757103v120100p.pdf</a>
TTA	TTAT.3G-37.571-3(R12-12.1.0)		12.1.0 Apr 15	<a href="http://www.tta.or.kr/data/ttasDown.jsp?where=14688&amp;pk_num=TTAT.3G-37.571-3(R12-12.1.0)">http://www.tta.or.kr/data/ttasDown.jsp?where=14688&amp;pk_num=TTAT.3G-37.571-3(R12-12.1.0)</a>
TTC	Not applicable			

### 1.2.1.6.12 TS 37.571-4

#### Universal Terrestrial Radio Access (UTRA) and Evolved UTRA (E-UTRA) and Evolved Packet Core (EPC); User Equipment (UE) conformance specification for UE positioning; Part 4: Test suites

This document specifies the protocol and signalling conformance testing in TTCN for the UE:

- A-GPS at the UTRA Uu interface;
- LTE positioning at the LTE-Uu interface;
- A-GNSS at the UTRA Uu interface.

The following TTCN test specification and design considerations can be found in this document:

- Test system architecture;
- Test models and ASP definitions;
- Test methods and usage of communication ports definitions;
- Test configurations;
- Design principles and assumptions;

- TTCN styles and conventions;
- Partial PIXIT proforma;
- Test suites in TTCN-2 and TTCN-3;
- The Test Suites designed and implemented in this document are based on the test specifications in prose in 3GPP TS 37.571-2;
- The applicability of the individual test cases is specified in the test ICS proforma specification in 3GPP TS 37.571-3.

SDO (2)	Document No.	Version	Issued date	Location (1)
<b>Release 10</b>				
ARIB	ARIB STD-T104-37.571-4		10.8.0 Mar 15	<a href="http://www.arib.or.jp/english/html/overview/doc/STD-T104v2_70/2_T104/ARIB-STD-T104/Rel10/37/A37571-4-a80.pdf">http://www.arib.or.jp/english/html/overview/doc/STD-T104v2_70/2_T104/ARIB-STD-T104/Rel10/37/A37571-4-a80.pdf</a>
ATIS	ATIS.3GPP.37.571-4V1080-2015		10.8.0 May 15	<a href="https://www.atis.org/docstore/default.aspx">https://www.atis.org/docstore/default.aspx</a>
CCSA	CCSA-TSD-LTE-37.571-4		10.8.0 Apr 15	<a href="http://www.ccsa.org.cn/ITU_spec/ITU-R/M.2012/M.2012-2/LTE/Rel-10/CCSA-TSD-LTE-37571-4-a80.zip">http://www.ccsa.org.cn/ITU_spec/ITU-R/M.2012/M.2012-2/LTE/Rel-10/CCSA-TSD-LTE-37571-4-a80.zip</a>
ETSI	ETSI TS 137 571-4		10.8.0 Jan 15	<a href="http://www.etsi.org/deliver/etsi_ts/137500_137599/13757104/10.08.00_60/ts_13757104v100800p.pdf">http://www.etsi.org/deliver/etsi_ts/137500_137599/13757104/10.08.00_60/ts_13757104v100800p.pdf</a>
TTA	TTAT.3G-37.571-4(R10-10.1.0)		10.1.0 Aug 13	<a href="http://www.tta.or.kr/data/ttasDown.jsp?where=14688&amp;pk_num=TTAT.3G-37.571-4(R10-10.1.0)">http://www.tta.or.kr/data/ttasDown.jsp?where=14688&amp;pk_num=TTAT.3G-37.571-4(R10-10.1.0)</a>
TTC	Not applicable			

#### 1.2.1.6.13 TS 37.571-5

### Universal Terrestrial Radio Access (UTRA) and Evolved UTRA (E-UTRA) and Evolved Packet Core (EPC); User Equipment (UE) conformance specification for UE positioning; Part 5: Test scenarios and assistance data

This document specifies the test scenarios and assistance data required for the conformance test for FDD or TDD mode of UTRA and E-UTRA for the User Equipment (UE) that supports one or more of the defined positioning methods. For UTRA these are Assisted Global Positioning System (A-GPS) and Assisted Global Navigation Satellite System (A-GNSS). For E-UTRA these are A-GNSS, Observed Time Difference of Arrival (OTDOA) and Enhanced Cell ID (ECID).

SDO (2)	Document No.	Version	Issued date	Location (1)
<b>Release 10</b>				
ARIB	ARIB STD-T104-37.571-5		10.10.0 Mar 15	<a href="http://www.arib.or.jp/english/html/overview/doc/STD-T104v2_70/2_T104/ARIB-STD-T104/Rel10/37/A37571-5-aa0.pdf">http://www.arib.or.jp/english/html/overview/doc/STD-T104v2_70/2_T104/ARIB-STD-T104/Rel10/37/A37571-5-aa0.pdf</a>
ATIS	ATIS.3GPP.37.571-5V10100-2015		10.10.0 May 15	<a href="https://www.atis.org/docstore/default.aspx">https://www.atis.org/docstore/default.aspx</a>
CCSA	CCSA-TSD-LTE-37.571-5		10.10.0 Apr 15	<a href="http://www.ccsa.org.cn/ITU_spec/ITU-R/M.2012/M.2012-2/LTE/Rel-10/CCSA-TSD-LTE-37571-5-aa0.zip">http://www.ccsa.org.cn/ITU_spec/ITU-R/M.2012/M.2012-2/LTE/Rel-10/CCSA-TSD-LTE-37571-5-aa0.zip</a>
ETSI	ETSI TS 137 571-5		10.10.0 Jan 15	<a href="http://www.etsi.org/deliver/etsi_ts/137500_137599/13757105/10.10.00_60/ts_13757105v101000p.pdf">http://www.etsi.org/deliver/etsi_ts/137500_137599/13757105/10.10.00_60/ts_13757105v101000p.pdf</a>
TTA	TTAT.3G-37.571-5(R10-10.3.0)		10.3.0 Aug 13	<a href="http://www.tta.or.kr/data/ttasDown.jsp?where=14688&amp;pk_num=TTAT.3G-37.571-5(R10-10.3.0)">http://www.tta.or.kr/data/ttasDown.jsp?where=14688&amp;pk_num=TTAT.3G-37.571-5(R10-10.3.0)</a>
TTC	Not applicable			
<b>Release 11</b>				
ARIB	ARIB STD-T104-37.571-5		11.0.0 Mar 15	<a href="http://www.arib.or.jp/english/html/overview/doc/STD-T104v2_70/2_T104/ARIB-STD-T104/Rel11/37/A37571-5-b00.pdf">http://www.arib.or.jp/english/html/overview/doc/STD-T104v2_70/2_T104/ARIB-STD-T104/Rel11/37/A37571-5-b00.pdf</a>
ATIS	ATIS.3GPP.37.571-5V1100-2015		11.0.0 May 15	<a href="https://www.atis.org/docstore/default.aspx">https://www.atis.org/docstore/default.aspx</a>
CCSA	CCSA-TSD-LTE-37.571-5		11.0.0 Apr 15	<a href="http://www.ccsa.org.cn/ITU_spec/ITU-R/M.2012/M.2012-2/LTE/Rel-11/CCSA-TSD-LTE-37571-5-b00.zip">http://www.ccsa.org.cn/ITU_spec/ITU-R/M.2012/M.2012-2/LTE/Rel-11/CCSA-TSD-LTE-37571-5-b00.zip</a>
ETSI	ETSI TS 137 571-5		11.0.0 Jan 15	<a href="http://www.etsi.org/deliver/etsi_ts/137500_137599/13757105/11.00.00_60/ts_13757105v110000p.pdf">http://www.etsi.org/deliver/etsi_ts/137500_137599/13757105/11.00.00_60/ts_13757105v110000p.pdf</a>
TTA	TTAT.3G-37.571-5(R11-11.0.0)		11.0.0 Apr 15	<a href="http://www.tta.or.kr/data/ttasDown.jsp?where=14688&amp;pk_num=TTAT.3G-37.571-5(R11-11.0.0)">http://www.tta.or.kr/data/ttasDown.jsp?where=14688&amp;pk_num=TTAT.3G-37.571-5(R11-11.0.0)</a>
TTC	Not applicable			

Release 12

ARIB	Not applicable			
ATIS	ATIS.3GPP.37.571-5V1200-2015	12.0.0	May 15	<a href="https://www.atis.org/docstore/default.aspx">https://www.atis.org/docstore/default.aspx</a>
CCSA	CCSA-TSD-LTE-37.571-5	12.0.0	Apr 15	<a href="http://www.ccsa.org.cn/ITU_spec/ITU-R/M.2012/M.2012-2/LTE/Rel-12/CCSA-TSD-LTE-37571-5-c00.zip">http://www.ccsa.org.cn/ITU_spec/ITU-R/M.2012/M.2012-2/LTE/Rel-12/CCSA-TSD-LTE-37571-5-c00.zip</a>
ETSI	ETSI TS 137 571-5	12.0.0	Jan 15	<a href="http://www.etsi.org/deliver/etsi_ts/137500_137599/13757105/12.00.00_60/ts_13757105v120000p.pdf">http://www.etsi.org/deliver/etsi_ts/137500_137599/13757105/12.00.00_60/ts_13757105v120000p.pdf</a>
TTA	TTAT.3G-37.571-5(R12-12.0.0)	12.0.0	Apr 15	<a href="http://www.tta.or.kr/data/ttasDown.jsp?where=14688&amp;pk_num=TTAT.3G-37.571-5(R12-12.0.0)">http://www.tta.or.kr/data/ttasDown.jsp?where=14688&amp;pk_num=TTAT.3G-37.571-5(R12-12.0.0)</a>
TTC	Not applicable			

## 1.2.2 Other specifications

The radio aspects of *LTE-Advanced* include the capabilities of LTE Release 8 and LTE Release 9. Information on the Radio specifications Release 8 and Release 9 is provided in § 1.2.2.1.

Furthermore, information on system and core network specifications is also provided for a complete system perspective. These system and core network specifications address the network, terminal, and service aspects required to provide an integrated mobility solution including aspects such as user services, connectivity, interoperability, mobility and roaming, security, codecs and media, operations and maintenance, charging, etc. Information on the System and core network specifications Release 8, Release 9, Release 10, Release 11 and Release 12 is provided in § 1.2.2.2.

### 1.2.2.1 Radio specifications

Release 8 and Release 9 of specifications listed in § 1.2.1 are provided as the foundation of the radio aspects of *LTE-Advanced*. They are available at <http://ties.itu.int/u/itu-r/ede/rsg5/IMT-Advanced/GCS/M.2012-2/LTE-Advanced/>.

### 1.2.2.2 System and core network specifications

The system and core network specifications listed in this section are available at <http://ties.itu.int/u/itu-r/ede/rsg5/IMT-Advanced/GCS/M.2012-2/LTE-Advanced/>.

#### 1.2.2.2.1 TS 21.111

##### USIM and IC card requirements

This specification describes the requirements of the USIM and the USIM IC card (UICC). These are derived from the service and security requirements defined in the respective specifications. The document is the basis for the detailed specification of the USIM and the UICC, and the interface to the terminal.

#### 1.2.2.2.2 TS 21.201

##### Technical specifications and technical reports relating to an Evolved Packet System (EPS) based 3GPP system

This document identifies the 3GPP technical specifications and technical reports required or potentially required to build a system based on the Evolved Packet System/LTE/E-UTRAN radio technology.

#### 1.2.2.2.3 TS 21.202

##### Technical Specifications and Technical Reports relating to the Common IP Multimedia Subsystem (IMS)

This document identifies the 3GPP Technical Specifications and Technical Reports specifically relating to the Common IP Multimedia Subsystem (IMS) maintained by 3GPP. Standards organizations adopting the Common IP Multimedia Subsystem (IMS) might not need to use all listed specifications.

#### 1.2.2.2.4 TR 21.905

##### Vocabulary

Document 21.905 is a collection of terms, definitions and abbreviations related to the baseline documents defining the objectives and systems framework. This document provides a tool for further work on the technical documentation and facilitates their understanding.

#### **1.2.2.2.5 TS 22.002**

##### **Bearer services supported by a GSM PLMN**

This specification describes a set of bearer services to be provided to subscribers by a 3G and beyond network itself and in connection with other networks. This document is also be used as a reference for defining the corresponding required mobile network capabilities which are specified by means of the connection type concept.

#### **1.2.2.2.6 TS 22.004**

##### **General on supplementary services**

This specification describes a recommended set of supplementary services to the teleservices and bearer services which will be supported by a 3G and beyond network in connection with other networks as a basis for the definition of the network capabilities required.

#### **1.2.2.2.7 TS 22.011**

##### **Service accessibility**

This specification describes the service access procedures as presented to the user. The document contains definitions and procedures are provided for international roaming, national roaming and regionally provided service. These are mandatory in relation to the technical realization of the UE.

#### **1.2.2.2.8 TS 22.016**

##### **International mobile equipment identities (IMEI)**

This specification describes the principal purpose and use of unique equipment identities.

#### **1.2.2.2.9 TS 22.022**

##### **Personalization of GSM ME mobile functionality specification – Stage 1**

This specification describes functional specifications of five features to personalize UE. These features are called:

- network personalization;
- network subset personalization;
- service provider (SP) personalization;
- corporate personalization;
- UMTS subscriber identity module (USIM) personalization.

This specification describes requirements for UE, which provide these personalization features.

#### **1.2.2.2.10 TS 22.034**

##### **High-speed circuit switched data (HSCSD) – Stage 1**

This specification describes the Stage 1 description of HSCSD. HSCSD is a feature that allows users subscribing to the general bearer services to access user rates that can be achieved with one or more traffic channel. HSCSD also defines a flexible use of air interface resources, which makes efficient and flexible use of higher user rates feasible.

**1.2.2.2.11 TS 22.038****SIM application toolkit (SAT) – Stage 1**

This specification describes the Stage 1 description of the SAT primarily from the subscriber's and serving environment's points of view, and does not deal with the details of the human interface itself. It includes information applicable to network operators, serving environments and terminal, switch and database manufacturers and contains the core requirements for a SAT which are sufficient to provide a complete service.

**1.2.2.2.12 TS 22.041****Operator Determined Barring (ODB)**

This document specifies the network feature Operator Determined Barring (ODB), which allows the network operator or service provider to regulate, by means of an exceptional procedure, access by the subscribers to services (both Circuit and Packet Oriented), by the barring of certain categories of outgoing or incoming calls/Packet Oriented Services or of roaming.

**1.2.2.2.13 TS 22.060****General packet radio service (GPRS) – Stage 1**

This specification describes the Stage 1 description of the GPRS.

**1.2.2.2.14 TS 22.067****Priority set-up service – Stage 1 (ASCI spec)**

This specification describes the Stage 1 description of the enhanced multi-level precedence and pre-emption (eMLPP) service. This service has two parts: precedence and pre-emption. Precedence involves assigning a priority level to a call in combination with fast call set-up.

Pre-emption involves the seizing of resources, which are in use by a call of a lower precedence, by a higher level precedence call in the absence of idle resources. Pre-emption can also involve the disconnection of an ongoing call of lower precedence to accept an incoming call of higher precedence.

**1.2.2.2.15 TS 22.071****Location services (LCS) – Stage 1**

LCS is a network provided enabling technology consisting of standardized service capabilities which enables the provision of location applications. This application may be service provider specific. The description of the numerous and varied possible location applications which are enabled by this technology are outside the scope of this specification. However, clarifying examples of how the functionality being specified may be used to provide specific LCS is included in various sections of the specification.

**1.2.2.2.16 TS 22.078****Customized applications for mobile network enhanced logic (CAMEL) – Stage 1**

This specification describes the Stage 1 description for CAMEL feature which provides the mechanisms to support services consistently independently of the serving network. The CAMEL features shall facilitate service control of operator specific services external from the serving network. The CAMEL feature is a network feature and not a supplementary service. It is a tool to help the network operator to provide the subscribers with the operator specific services even when roaming outside the home network.



**1.2.2.2.17 TS 22.081****Line Identification supplementary services; Stage 1**

This document specifies the supplementary services belonging to the group Line Identification Supplementary Services, which consist of Calling line identification presentation (CLIP), Calling line identification restriction (CLIR), Connected line identification presentation (COLP), and Connected line identification restriction (COLR).

**1.2.2.2.18 TS 22.082****Call Forwarding (CF) Supplementary Services; Stage 1**

This document specifies the supplementary services belonging to the group Call Offering Supplementary Services, which consist of Call forwarding unconditional, Call forwarding on mobile subscriber busy, Call forwarding on no reply, and Call forwarding on mobile subscriber not reachable.

**1.2.2.2.19 TS 22.083****Call Waiting (CW) and Call Holding (HOLD); Supplementary Services; Stage 1**

This document specifies the supplementary services belonging to the group Call Completion Supplementary Services, which consist of Call waiting and Call hold.

**1.2.2.2.20 TS 22.084****MultiParty (MPTY) supplementary service; Stage 1**

This document specifies the supplementary services belonging to the group MultiParty Supplementary Services, which consist of MultiParty service.

**1.2.2.2.21 TS 22.085****Closed User Group (CUG) supplementary services; Stage 1**

This document specifies the supplementary services belonging to the group Community Of Interest Supplementary Services, which consist of Closed user group.

**1.2.2.2.22 TS 22.086****Advice of Charge (AoC) supplementary services; Stage 1**

This document specifies the supplementary services belonging to the group Charging Supplementary Services, which consist of Advice of Charge (Information) and Advice of Charge (Charging).

**1.2.2.2.23 TS 22.087****User-to-User Signalling (UUS); Service description; Stage 1**

This document specifies the User-to-User Signalling (UUS) supplementary service, which allows a mobile subscriber to send/receive a limited amount of information to/from another PLMN or ISDN subscriber over the signalling channel in association with a call to the other subscriber.

**1.2.2.2.24 TS 22.088****Call Barring (CB) supplementary services; Stage 1**

This document specifies the supplementary services belonging to the group Call Restriction Supplementary Services, which consist of barring of outgoing calls and barring of incoming calls.

**1.2.2.2.25 TS 22.090****Unstructured supplementary service data (USSD); Stage 1**

There are two modes of USSD: MMI-mode and application mode. MMI-mode USSD is for the transparent transport of MMI strings entered by the user to the network and for the transparent transport of text strings from the network that are displayed by the mobile for user information. Application mode USSD is for the transparent transport of data between the network and the mobile station. Application mode USSD is intended to be used by applications in the network and their peer applications in the UE. The communication over the radio interface takes place on the signalling channels using short dialogues with peak data throughput rate capabilities of up to approximately 600 bits/s outside of a call and 1 000 bits/s during a call.

**1.2.2.2.26 TS 22.091****Explicit Call Transfer (ECT) supplementary service; Stage 1**

This document specifies the stage 1 description of Explicit Call Transfer (ECT) from the service subscriber's and user's points of view, in particular, the procedures for normal operation with successful outcome, the action to be taken in exceptional circumstances, and the interaction with other supplementary services.

**1.2.2.2.27 TS 22.093****Completion of Calls to Busy Subscriber (CCBS); Service description, Stage 1**

This document specifies the stage 1 description of Completion of Calls to Busy Subscriber (CCBS) from the subscriber's and user's points of view, in particular, the procedures for normal operation with successful outcome, the action to be taken in exceptional circumstances, and the interaction with other supplementary services.

**1.2.2.2.28 TS 22.094****Follow Me service description; Stage 1**

This document specifies the stage 1 description for the Follow Me feature, which enables a mobile subscriber A to manipulate the Follow Me data of a party B in such a way that – under certain conditions – subsequent calls directed to party B will be forwarded to subscriber A.

**1.2.2.2.29 TS 22.096****Name identification supplementary services; Stage 1**

This document specifies the supplementary services belonging to the group Name Identification supplementary services, which consist of Calling Name Presentation (CNAP).

**1.2.2.2.30 TS 22.101****UMTS service principles**

This specification describes the service principles of the UMTS.

**1.2.2.2.31 TS 22.105****Services and service capabilities**

Pre-UMTS systems have largely standardized the complete sets of bearer services, teleservices and supplementary services which they provide. One major difference between UMTS and preUMTS systems is that service capabilities rather than services are standardized for UMTS, allowing service

differentiation and system continuity. This document describes how and what kind of services the UMTS user has access to.

#### **1.2.2.2.32 TS 22.115**

##### **Service aspects: charging and billing**

This specification describes the service aspects of charging and billing of the UMTS. This standard is not intended to duplicate existing standards or standards being developed by other groups on these topics, and will reference these where appropriate. This standard will elaborate on the charging requirements described in the charging principles in TS 22.101 UMTS service principles. It will allow the generation of accurate charging information to be used in the commercial and contractual relationships between the parties concerned.

#### **1.2.2.2.33 TS 22.129**

##### **Handover requirements between UMTS and GSM or other radio systems**

This specification describes service requirements for handover (terms are defined below) within UMTS systems and between UMTS, other IMT-2000 family members and second generation systems. Particular emphasis has been placed on the description of requirements for handover between UMTS and GSM but requirements specific to other systems are incorporated as required.

#### **1.2.2.2.34 TS 22.135**

##### **Multicall**

This specification describes multicall scenarios and requirements for UMTS phase 1 release 1999. Multicall feature specifies functionality and interactions related to usage of several simultaneous bearers between a terminal and a network. Multicall features allow both circuit-switched call(s) and packet session(s) to exist simultaneously.

#### **1.2.2.2.35 TS 22.146**

##### **Multimedia Broadcast/Multicast Service (MBMS) user services; Stage 1**

The document describes MBMS User Services that use the capabilities of MBMS. Application scenarios including charging, QoS aspects and related service requirements derived from them are described. These scenarios and service requirements can be used as guidance for the design of codecs and bearers.

#### **1.2.2.2.36 TS 22.153**

##### **Multimedia priority service**

The document specifies the service requirements for Multimedia Priority Service (MPS). Its scope is to specify those requirements of MPS necessary to provide an end-to-end service and to interwork with external networks where needed. Service interactions with external networks are considered within the scope of this document although these interactions may be specified in other standards.

#### **1.2.2.2.37 TS 22.173**

##### **Multimedia telephony service and supplementary services; Stage 1**

The document defines the IMS multimedia telephony service and the minimum set of capabilities required to secure multi-vendor and multi-operator inter-operability for multimedia telephony and related supplementary services.

**1.2.2.2.38 TS 22.182****Customized Alerting Tones (CAT) requirements; Stage 1**

This document specifies the requirements and technical considerations for Customized Alerting Tone (CAT) service in both CS and PS domains, especially additional features for roaming and interoperability support.

**1.2.2.2.39 TS 22.183****Customized Ringing Signal (CRS) requirements; Stage 1**

The document specifies the requirements and technical considerations for Customized Ringing Signal (CRS) service in the PS and CS domains, especially additional features for roaming and interoperability support.

**1.2.2.2.40 TS 22.220****Service requirements for Home NodeB (HNB) and Home eNodeB (HeNB)**

This specification defines the service requirements for the basic functionalities for the support of Home NodeB (HNB) and Home eNodeB (HeNB) – jointly referred to as H(e)NB – and the further functionalities that will enable the mobile operators to provide more advanced services as well as improving the user experience.

**1.2.2.2.41 TS 22.228****IP Multimedia Subsystem Stage 1**

This specification describes all IP Multimedia services offered by UMTS Systems and second generation systems.

**1.2.2.2.42 TS 22.234****Requirements on 3GPP system to Wireless Local Area Network (WLAN) interworking**

The document specifies the functional requirements placed on the 3GPP system for interworking WLAN with the 3GPP system. Guidance is given for WLAN operators intending to provide the interworked WLAN capability.

**1.2.2.2.43 TS 22.246****Multimedia Broadcast/Multicast Service (MBMS) user services; Stage 1**

This document describes MBMS User Services that use the capabilities of MBMS. Application scenarios including charging, QoS aspects and related service requirements derived from them are described. These scenarios and service requirements can be used as guidance for the design of codecs and bearers.

**1.2.2.2.44 TS 22.268****Public Warning System (PWS) requirements**

This document covers the core requirements for the PWS that are sufficient to provide a complete service. This TS also covers subsystem additional requirements for the Earthquake and Tsunami Warning System (ETWS) and the Commercial Mobile Alert System (CMAS).

**1.2.2.2.45 TS 22.278****Service requirements for the Evolved Packet System (EPS)**

This document describes the service requirements for the Evolved Packet System.

**1.2.2.2.46 TS 22.279****Combined Circuit Switched (CS) and IP Multimedia Subsystem (IMS) sessions; Stage 1**

This document specifies service requirements for Combining CS and IMS services using a CS speech or CS multimedia call in association with an IMS session.

**1.2.2.2.47 TS 22.368****Service requirements for Machine-Type Communications (MTC); Stage 1**

This document specifies the service requirements for Network Improvements for Machine Type Communications. In particular it will:

- identify and specify general requirements for machine type communications;
- identify service aspects where network improvements (compared to the current human-to-human oriented services) are needed to cater for the specific nature of machine-type communications;
- specify machine type communication requirements for these service aspects where network improvements are needed for machine type communication.

**1.2.2.2.48 TS 22.468****Group Communication System Enablers for LTE (GCSE\_LTE)**

This document collects the requirements as relevant to improve the EPC and E-UTRAN for system enablers to the 3GPP system to support Group Communication over LTE for Public Safety and Critical Communication.

The US requirements as specified in NPSTC (Mission Critical Voice Requirements), the TETRA + Critical Communications Association (TCCA) and ITU inputs are taken as starting point.

Other regional requirements may also be reflected in the work. The requirements are worded in a way to easily accommodate future requirements from other regions or stakeholders.

**1.2.2.2.49 TS 22.519****Business communication requirements**

This document specifies network requirements:

- to support connection and interoperation of business communication capabilities (either hosted in NGCN or NGN) to the NGN; and
- to support connection and interoperation of business communication capabilities to other business communication capabilities (either hosted in NGCN or NGN); and
- to support connection and interoperation of business communication capabilities to other business communication capabilities located in or connected to the ISDN and PSTN; and
- to support PABX functionality (hosted enterprise services) in an NGN.

NOTE 1: Network requirements to support connection of NGCN directly connected to an NGN are specified.

NOTE 2: Attachment of legacy PBX functionality to the NGN is not specified in this document. It is assumed that existing legacy service requirements apply in this case.

This document also specifies network requirements for communication between NGCN capabilities (including user equipment) to other NGCN capabilities of the same enterprise through the NGN (e.g. geographically separated).

This document does not specify NGCN services, nor does it specify network based application services provided to a user of an NGCN.

#### **1.2.2.2.50 TS 23.002**

##### **Network architecture**

This specification describes the possible architectures of the mobile system.

#### **1.2.2.2.51 TS 23.003**

##### **Numbering, addressing and identification**

This document defines the principal purpose and use of International Mobile station Equipment Identities (IMEI) within the digital cellular telecommunications system and the 3GPP system.

#### **1.2.2.2.52 TS 23.007**

##### **Restoration procedures**

The data stored in location registers are automatically updated in normal operation; the main information stored in a location register defines the location of each mobile station and the subscriber data required to handle traffic for each mobile subscriber. The loss or corruption of these data will seriously degrade the service offered to mobile subscribers; it is therefore necessary to define procedures to limit the effects of failure of a location register, and to restore the location register data automatically. This document defines the necessary procedures.

#### **1.2.2.2.53 TS 23.008**

##### **Organization of subscriber data**

This document provides details concerning information to be stored in home subscriber servers, visitor location registers, GPRS Support Nodes and Call Session Control Function (CSCF) concerning mobile subscriber.

#### **1.2.2.2.54 TS 23.011**

##### **Technical realization of Supplementary Services**

This document describes the general aspects on how supplementary services in the 3GPP system are realized from a technical point of view. Description of technical realisation for specific supplementary services can be found in 3GPP TS 23.072.

All supplementary services may require signalling on the radio path. For some supplementary services information needs to be transferred between the Home Location Register (HLR), the Visitor Location Register (VLR), the Mobile services Switching Centre (MSC) and the Serving GPRS Support Node (SGSN). Signalling procedures for such information transfer are defined in 3GPP TS 29.002.

#### **1.2.2.2.55 TS 23.018**

##### **Basic call handling; Technical realization**

This document specifies the technical realization of the handling of calls originated by a UMTS or GSM mobile subscriber and calls directed to a UMTS or GSM mobile subscriber, up to the point

where the call is established. Normal release of the call after establishment is also specified. Trunk Originated call is also modelled.

#### **1.2.2.2.56 TS 23.034**

##### **High Speed Circuit Switched Data (HSCSD) – Stage 2**

This document describes the stage 2 service description for a High Speed Circuit Switched Data (HSCSD) on GSM/GERAN in  $A/G_b$  mode and  $I_u$  mode. HSCSD utilizes the multislot mechanism, i.e. using multiple traffic channels (/bearers) for the communication.

Additionally, the document specifies some HSCSD related requirements for multi system mobile stations operating in UTRAN  $I_u$  mode. Stage 2 identifies the functional capabilities and information flows needed to support the service. Furthermore, it identifies various possible physical locations for the functional capabilities.

#### **1.2.2.2.57 TS 23.038**

##### **Alphabets and language-specific information**

This specification describes the language specific requirements for the terminals including character coding.

#### **1.2.2.2.58 TS 23.040**

##### **Technical realization of the Short Message Service (SMS)**

This specification describes the point-to-point SMS.

#### **1.2.2.2.59 TS 23.041**

##### **Technical realization of Cell Broadcast Service (CBS)**

This specification describes the point-to-multipoint CBS.

#### **1.2.2.2.60 TS 23.042**

##### **Compression algorithm for text messaging services**

This specification describes the compression algorithm for text messaging services.

#### **1.2.2.2.61 TS 23.057**

##### **Mobile Execution Environment (MExE) – Stage 2**

This TS describes the functional capabilities and the security architecture of the Mobile Execution Environment.

#### **1.2.2.2.62 TS 23.060**

##### **General packet radio service (GPRS) service description – Stage 2**

This specification describes a general overview over the GPRS architecture as well as a more detailed overview of the MS – CN protocol architecture. Details of the protocols will be specified in companion documents.

#### **1.2.2.2.63 TS 23.078**

##### **Customized Applications for Mobile network Enhanced Logic (CAMEL) Phase 4; Stage 2**

This document specifies the stage 2 description for the fourth phase of the Customized Applications for Mobile network Enhanced Logic (CAMEL) feature which provides the mechanisms to support

services of operators which are not covered by standardized services even when roaming outside the HPLMN.

The CAMEL feature is a network feature and not a supplementary service. It is a tool to help the network operator to provide the subscribers with the operator specific services even when roaming outside the HPLMN. CAMEL applicability to IP-based multimedia services is introduced in the fourth phase of the CAMEL. It is specified in 3GPP TS 23.278.

#### **1.2.2.2.64 TS 23.081**

##### **Line Identification supplementary services; Stage 2**

This document gives the stage 2 description of the call identification supplementary services.

The group line identification supplementary services are divided into the following four supplementary services:

- Calling line identification presentation CLIP;
- Calling line identification restriction CLIR;
- Connected line identification presentation COLP;
- Connected line identification restriction COLR.

#### **1.2.2.2.65 TS 23.082**

##### **Call Forwarding (CF) supplementary services; Stage 2**

This document gives the stage 2 description of the call forwarding supplementary services.

The group of supplementary services call offering supplementary services is divided into 4 different supplementary services:

- Call forwarding unconditional (CFU);
- Call forwarding on mobile subscriber busy (CFB);
- Call forwarding on no reply (CFNRy);
- Call forwarding on mobile subscriber not reachable (CFNRc).

#### **1.2.2.2.66 TS 23.083**

##### **Call Waiting (CW) and Call Hold (HOLD) supplementary services; Stage 2**

This document gives the stage 2 description of the call completion supplementary services.

The group of call completion supplementary services is divided into the following two supplementary services:

- Call waiting (CW);
- Call hold (HOLD).

#### **1.2.2.2.67 TS 23.084**

##### **Multi Party (MPTY) supplementary service; Stage 2**

This document gives the stage 2 description of the multi party supplementary services.

Only one multi party supplementary service has been defined, this is the Multi Party (MPTY) service.



**1.2.2.2.68 TS 23.085****Closed User Group (CUG) supplementary service; Stage 2**

This document gives the stage 2 description of the closed user group supplementary service.

The community of interest supplementary service defined is:

- Closed user group (CUG).

**1.2.2.2.69 TS 23.086****Advice of Charge (AoC) supplementary services; Stage 2**

This document gives the stage 2 description of the Advice of Charge (AoC) supplementary services.

The charging supplementary services currently defined are:

- Advice of Charge (Information) (AoCI);
- Advice of Charge (Charging) (AoCC).

**1.2.2.2.70 TS 23.087****User-to-User Signalling (UUS) supplementary service; Stage 2**

This document gives the stage 2 description of the User-to-User signalling supplementary services.

The User-to-user supplementary service is divided into 3 different services:

- Service 1 (UUS1)
- Service 2 (UUS2)
- Service 3 (UUS3)

**1.2.2.2.71 TS 23.088****Call Barring (CB) Supplementary Services; Stage 2**

This document gives the stage 2 description of the call barring services.

The possibility for a mobile subscriber to have certain categories of calls barred originated from or terminated at his access:

Barring of outgoing calls:

- Barring of all outgoing calls (BAOC) (Barring program 1);
- Barring of outgoing international calls (BOIC) (Barring program 2);
- Barring of outgoing international calls EXCEPT those directed to the home PLMN country (BOIC-exHC) (Barring program 3).

Barring of incoming calls:

- Barring of all incoming calls (BAIC) (Barring program 1);
- Barring of incoming calls when roaming outside the home PLMN country (BIC-Roam) (Barring program 2);
- Anonymous Call Rejection (ACR) (Barring program 3).

The call barring program “incoming calls when roaming outside the home PLMN country” is only relevant if as a general rule the called mobile subscriber pays the charges for the forwarded part of the call from his home PLMN country to any other country.

**1.2.2.2.72 TS 23.090****Unstructured Supplementary Service Data (USSD); Stage 2**

This document gives the stage 2 description of Unstructured Supplementary Service Data (USSD).

The USSD mechanism allows the Mobile Station (MS) user and a PLMN operator defined application to communicate in a way which is transparent to the MS and to intermediate network entities. The mechanism allows development of PLMN specific supplementary services.

This document defines the requirements for handling USSD at the MS and network entities. It does not include specification of particular applications, nor does it specify how a particular application is selected. Where more than one application exists at a network entity, routing of messages to the correct application is carried out by the USSD handler. The MMI for USSD is specified in 3GPP TS 22.030 and 3GPP TS 22.090. The alphabet indicator and the data coding scheme are defined in 3GPP TS 23.038.

USSD may be initiated by the MS user, or by the network in the following ways:

- Network initiated USSD;
- Mobile initiated USSD.

**1.2.2.2.73 TS 23.091****Explicit Call Transfer (ECT) supplementary service; Stage 2**

This document gives the stage 2 description of the call transfer supplementary services.

Only one call transfer supplementary service has been defined, this is the Explicit Call Transfer (ECT) supplementary service, and it is described in this document.

**1.2.2.2.74 TS 23.093****Technical realization of Completion of Calls to Busy Subscriber (CCBS); Stage 2**

This document gives the stage 2 description of the Completion of Calls to Busy Subscriber (CCBS) supplementary service.

**1.2.2.2.75 TS 23.094****Follow-Me (FM); Stage 2**

This document specifies the stage 2 description for the Follow Me feature.

The Follow Me feature enables a mobile subscriber A to manipulate the Follow Me data of a remote party B in such a way that subsequent calls directed to remote party B will be forwarded to subscriber A.

**1.2.2.2.76 TS 23.096****Name identification supplementary services; Stage 2**

This document gives the stage 2 description of the Name Identification Supplementary Services.

The group of Name Identification Supplementary Services contains the following Supplementary Service:

CNAP – Calling name presentation.

**1.2.2.2.77 TS 23.101****General UMTS architecture**

This specification describes the basic physical and functional separation of UMTS. The content of this specification is limited to those features that are common to all UMTS networks independent of their origin. It identifies and names the reference points and functional groupings appearing at this level.

**1.2.2.2.78 TS 23.107****QoS concept and architecture**

This specification describes the framework for QoS in UMTS. The document shall be used as a living document which will cover all issues related QoS in UMTS.

**1.2.2.2.79 TS 23.108****Mobile radio interface layer 3 specification, core network protocols; Stage 2**

This specification describes the procedures used at the radio interface for Call Control (CC), Mobility Management (MM) and Session Management (SM). It contains examples of the structured procedures.

**1.2.2.2.80 TS 23.110****UMTS access stratum services and functions**

This specification describes the detailed specifications of the protocols which rule the information flows, both control and user data, between the access stratum and the parts of UMTS outside the access stratum, and of the detailed specifications of the UTRAN. These detailed specifications are to be found in other technical specifications.

**1.2.2.2.81 TS 23.122****Non-Access-Stratum (NAS) functions related to Mobile Station (MS) in idle mode**

This specification provides an overview of the tasks undertaken by a Mobile Station (MS) when in idle mode (that is, switched on but not having a dedicated channel allocated, e.g. not making or receiving a call; or when in group receive mode, that is, receiving a group call or broadcast call but not having a dedicated connection). It also describes the corresponding network functions.

**1.2.2.2.82 TS 23.142****Value-added Services for SMS (VAS4SMS) – Interface and Signalling Flow**

The specification describes the stage 2 of the VAS4SMS (Value Added Service for SMS). It includes:

- the logic architecture;
- the logic elements functionality;
- the signalling flows;
- the interaction with other features.

**1.2.2.2.83 TS 23.153****Out-of-band transcoder control; Stage 2**

This document specifies the stage 2 description of the Out-of-Band Transcoder Control for speech services. It describes the principles and procedures to support Transcoder Free Operation, Tandem

Free Operation and the interworking between TrFO and TFO. Transcoder at the edge is also part of this document.

#### **1.2.2.2.84 TS 23.167**

##### **IP Multimedia Subsystem (IMS) emergency sessions**

This document defines the stage 2 service description for emergency services in the IP Multimedia Core Network Subsystem (IMS), including the elements necessary to support IP Multimedia (IM) emergency services.

#### **1.2.2.2.85 TS 23.203**

##### **Policy and charging control architecture**

This document specifies the overall stage 2 level functionality for Policy and Charging Control that encompasses the following high level functions for IP-CANs (e.g. GPRS, I-WLAN, Fixed Broadband, etc.): (i) Flow Based Charging, including charging control and online credit control; (ii) Policy control (e.g. gating control, QoS control, QoS signalling, etc.).

#### **1.2.2.2.86 TS 23.204**

##### **Support of Short Message Service (SMS) over generic 3GPP Internet Protocol (IP) access; Stage 2**

This document specifies the new capabilities and enhancements needed to support SMS over a generic IP Connectivity Access Network (IP-CAN) using IMS capabilities.

#### **1.2.2.2.87 TS 23.205**

##### **Bearer-independent circuit-switched core network; Stage 2**

This document defines the stage 2 description for the bearer independent CS core network. The stage 2 shall cover the information flow between the GMSC server, MSC server and media gateways. Note that nothing in this document shall preclude an implementation of a combined MSC Server and MGW. This document shall show the CS core network termination of the Iu interface in order to cover the information flow stimulus to the core network and describe the interaction with the supplementary and value added services and capabilities.

#### **1.2.2.2.88 TS 23.216**

##### **Single Radio Voice Call Continuity (SRVCC)**

This technical specification specifies the architecture enhancements for Single Radio Voice Call Continuity (SRVCC) between E-UTRAN access and 3GPP2's 1xCS, and between E-UTRAN access and 3GPP's UTRAN/GERAN accesses and between UTRAN (HSPA) access and 3GPP's UTRAN/GERAN accesses, for Circuit Switched (CS) calls that are anchored in the IMS.

#### **1.2.2.2.89 TS 23.218**

##### **IP Multimedia (IM) session handling; IM call model; Stage 2**

This document specifies the IP multimedia (IM) Call Model for handling of an IP multimedia session origination and termination for an IP Multimedia subscriber. This document includes interactions between an application server and IP multimedia sessions.

**1.2.2.2.90 TS 23.228****IP Multimedia Subsystem; Stage 2**

This document describes the architectural requirement for an IP multimedia components incorporated in an UMTS system as well as second generation systems for GSM inside the core network and identify relevant interfaces to the existing system and the new one in between the new components incorporated.

**1.2.2.2.91 TS 23.231****SIP-I based circuit-switched core network; Stage 2**

This document defines the stage 2 description for the SIP-I based CS core network. This stage 2 shall cover the information flows between the GMSC server, MSC server and media gateways that are required to support a SIP-I based Nc interface. This document shall show the CS core network termination of the Iu and A interfaces in order to cover the information flow stimulus to the core network and describe the interaction with the supplementary and value added services and capabilities.

**1.2.2.2.92 TS 23.234****3GPP system to Wireless Local Area Network (WLAN) interworking; System description**

This document specifies system description for interworking between 3GPP systems and Wireless Local Area Networks (WLANs), which extends 3GPP services and functionality to the WLAN access environment. It is not limited to WLAN technologies, but also valid for other IP based Access Networks that support the same capabilities towards the interworking system as WLAN does.

**1.2.2.2.93 TS 23.237****IP Multimedia Subsystem (IMS) Service Continuity; Stage 2**

This document specifies the architectural requirements and procedures for delivery of IMS Service Continuity.

**1.2.2.2.94 TS 23.246****Multimedia Broadcast/Multicast Service (MBMS); Architecture and functional description**

This document describes the stage 2 description (architectural solution and functionalities) for the MBMS Bearer Service, which includes, together with MBMS User Services defined in TS 26.346, all the elements necessary to realise the stage 1 requirements in TS 22.146 and TS 22.246. This document encompasses both GPRS and EPS.

This document also includes considerations on the manner in which User Services should make use of the MBMS Bearer Service described herein. It should be noted that the specification of MBMS User Services in TS 26.346 takes precedence over User Service aspects described in this document.

This document includes information applicable to network operators, service providers and manufacturers.

**1.2.2.2.95 TS 23.259****Personal Network Management (PNM); Procedures and information flows; Stage 2**

This document provides the procedure details and the information flows for support of Personal Network Management including the PN UE redirection and PN access control applications enabled by Personal Network Management (PNM).

**1.2.2.2.96 TS 23.261****IP flow mobility and seamless Wireless Local Area Network (WLAN) offload; Stage 2**

This document specifies the Stage 2 system description for IP flow mobility between a 3GPP and a WLAN. The technical solution is based on the working principles of DSMIPv6 and it is applicable to both the Evolved Packet System and the I-WLAN mobility architecture. The specification covers the system description of seamless WLAN offload and IP flow mobility between 3GPP and WLAN as well as the respective interactions with the PCC and ANDSF frameworks. The system description for non-seamless WLAN offload is covered in 3GPP TS 23.402. This document specifies also the detailed extensions to S2c and H1 reference points for IP flow mobility. The extensions to the PCC and to the ANDSF framework are specified respectively in 3GPP TS 23.203 and in 3GPP TS 23.402.

**1.2.2.2.97 TS 23.271****Functional stage 2 description of Location Services (LCS)**

This document specifies the stage 2 of the Location Services (LCS) feature in UMTS, GSM and EPS (for E-UTRAN), which provides the mechanisms to support mobile location services for operators, subscribers and third party service providers.

**1.2.2.2.98 TS 23.272****Circuit Switched Fallback in Evolved Packet System**

This technical specification specifies the architecture enhancements for functionality to enable fallback from E-UTRAN access to UTRAN/GERAN CS domain access and to CDMA 1x RTT CS domain access, and functionality to reuse of voice and other CS-domain services (e.g. CS UDI video/SMS/LCS/USSD) by reuse of CS infrastructure.

**1.2.2.2.99 TS 23.278****Customized Applications for Mobile network Enhanced Logic (CAMEL) Phase 4; Stage 2; IM CN Interworking**

This document specifies the stage 2 description for the Customized Applications for Mobile network Enhanced Logic (CAMEL) feature which provides the mechanisms to support services for the IP Multimedia Core Network (IM CN) Subsystem.

**1.2.2.2.100 TS 23.279****Combining Circuit Switched (CS) and IP Multimedia Subsystem (IMS) services; Stage 2**

This document provides architectural details to combine CS services and IMS services for using them in parallel between the same two users in a peer-to-peer context. This document provides a detailed description of how capabilities and identities are exchanged to enable the combination of CS and IMS services between the same two UEs.

**1.2.2.2.101 TS 23.292****IP Multimedia Subsystem (IMS) centralized services; Stage 2**

This document specifies the architectural requirements for delivery of consistent services to the user regardless of the attached access type (e.g. CS domain access, or IP-CAN). This is achieved by implementing the services in the IP Multimedia Subsystem (IMS).

**1.2.2.2.102 TS 23.303****Proximity-based services (ProSe); Stage 2**

This document specifies the Stage 2 of the Proximity Services (ProSe) features in EPS. ProSe features consist of: ProSe discovery (direct or EPC-level) and ProSe Direct Communication (using E-UTRAN or WLAN direct).

ProSe discovery identifies that ProSe-enabled UEs are in proximity, using E-UTRAN (with or without E-UTRAN) or EPC.

ProSe Direct Communication enables establishment of communication paths between two or more ProSe-enabled UEs that are in direct communication range. The ProSe Direct Communication path could use E-UTRAN or WLAN.

For Public Safety specific usage:

- Public Safety ProSe-enabled UEs can establish the communication path directly between two or more Public Safety ProSe-enabled UEs, regardless of whether the Public Safety ProSe-enabled UE is served by E-UTRAN.
- ProSe Direct Communication is also facilitated by the use of a ProSe UE-to-Network Relay, which acts as a relay between E-UTRAN and UEs not served by E-UTRAN.

Security aspects of ProSe are defined in TS 33.303.

In this Release of the specification, there is no support for ProSe UE-to-Network Relays.

#### **1.2.2.2.103 TS 23.327**

#### **Mobility between 3GPP-Wireless Local Area Network (WLAN) interworking and 3GPP systems**

This document specifies the stage 2 system description for providing mobility between 3GPP Wireless Local Area Network Interworking (I WLAN) and 3GPP Systems. It is to define a technical solution based on the working principles of DSMIPv6 with necessary enhancement of the I WLAN architecture for supporting mobility and roaming between 3GPP WLAN Interworking system and 3GPP Systems so that ongoing 3GPP PS based services can be maintained with minimal impact on the end user's perceived quality on the services at a change of the access network (between I WLAN and 3GPP Access Systems).

#### **1.2.2.2.104 TS 23.333**

#### **Multimedia Resource Function Controller (MRFC) – Multimedia Resource Function Processor (MRFP) Mp interface; Procedures descriptions**

This specification describes the functional requirements and information flows that generate procedures between the Multimedia Resource Function Controller (MRFC) and the Multimedia Resource Function Processor (MRFP), limited to information flows relevant to the Mp Interface.

#### **1.2.2.2.105 TS 23.334**

#### **IP Multimedia Subsystem (IMS) Application Level Gateway (IMS-ALG) – IMS Access Gateway (IMS-AGW) interface: Procedures descriptions**

Annex G of 3GPP TS 23.228 gives out an IMS Application Level Gateway (IMS-ALG) and IMS Access Media Gateway (IMS-AGW) based reference model to support NAPT-PT, gate control and traffic policing between IP-CAN and IMS domain.

#### **1.2.2.2.106 TS 23.335**

##### **User Data Convergence (UDC); Technical realization and information flows; Stage 2**

This document describes the procedures and signalling flows associated to the technical realization of the 3GPP User Data Convergence (UDC). It furthermore indicates some requirements for the stage 3 specifications. Special consideration is put in the following areas:

- reference architecture for the UDC concept;
- general description of procedures for the user data manipulation (e.g. create, delete, update, etc.);
- identification of the requirements on the UDC for the applicability of the mechanisms described in this document.

User data convergence is an optional concept to ensure data consistency and simplify creation of new services by providing easy access to the user data, as well as to ensure the consistency of storage and data models and to have minimum impact on traffic mechanisms, reference points and protocols of network elements.

#### **1.2.2.2.107 TS 23.380**

##### **IMS Restoration procedures**

This document specifies the procedures required in 3GPP IMS to handle an S-CSCF service interruption scenario with minimum impact to the service to the end user.

#### **1.2.2.2.108 TS 23.401**

##### **GPRS enhancements for E-UTRAN access**

This technical specification defines the stage 2 service description for the Evolved 3GPP Packet Switched Domain – also called the Evolved Packet System (EPS) in this document. The Evolved 3GPP Packet Switched Domain provides IP connectivity using the Evolved Universal Terrestrial Radio Access Network (E-UTRAN). The specification also covers mobility between E-UTRAN and pre-E-UTRAN 3GPP radio access technologies.

#### **1.2.2.2.109 TS 23.402**

##### **Architecture enhancements for non-3GPP accesses**

This technical specification defines the stage 2 service description for providing IP connectivity using non-3GPP accesses to the Evolved 3GPP Packet Switched domain. In addition, for E-UTRAN and non-3GPP accesses, the specification describes the Evolved 3GPP PS Domain where the protocols between its Core Network elements are IETF based.

#### **1.2.2.2.110 TS 23.468**

##### **Group Communication System Enablers for LTE (GCSE\_LTE); Stage 2**

This document provides the stage 2 description for the 3GPP system provided enablers to support group communication services using EUTRAN access. The corresponding stage 1 requirements are defined in TS 22.468.

The group communication system is represented by an Application Server (GCS AS) using the 3GPP system provided enablers for transferring its application signalling and for delivering application data, e.g. media data, to a group of UEs either (i) over MBMS Bearer Services using the Broadcast Mode of MBMS (TS 23.246); or (ii) over EPS Bearers; or (iii) over both MBMS and EPS bearer services.



The specification covers both roaming and non-roaming scenarios and also includes support for service continuity, i.e. support for continuous reception of application data when a UE changes between reception of application data via EPS and MBMS Bearer Services.

Application level interactions between the UE and the GCS Application Server are out of scope of this specification.

#### **1.2.2.2.111 TS 23.682**

##### **Architecture enhancements to facilitate communications with packet data networks and applications**

This document specifies architecture enhancements to facilitate communications with packet data networks and applications (e.g. Machine Type Communication (MTC) applications on the (external) network/MTC servers) as per the use cases and service requirements defined in TS 22.368, TS 22.101, and related 3GPP requirements specifications. Both roaming and non-roaming scenarios are covered.

In this release, this document specifies the network elements, interfaces and procedures for:

- Device triggering by applications/servers (e.g. MTC applications on the (external) network/MTC servers).
- PS-Only support with and without MSISDN.

#### **1.2.2.2.112 TS 24.002**

##### **GSM – UMTS Public Land Mobile Network (PLMN) access reference configuration**

This document describes the reference configuration for access to a PLMN.

#### **1.2.2.2.113 TS 24.007**

##### **Mobile radio interface signalling layer 3; General aspects**

This specification describes the principal architecture of Layer 3 and its sub-layers on the GSM Um interface, i.e. the interface between mobile station (MS) and network; for the CM sub-layer, the description is restricted to paradigmatic examples, CC, supplementary services, and short message services for non-general packet radio service (GPRS) services. It also defines the basic message format and error handling applied by the Layer 3 protocols.

#### **1.2.2.2.114 TS 24.008**

##### **Mobile radio interface Layer 3 specification; Core network protocols; Stage 3**

This specification describes the procedures used at the radio interface for call control, mobility management and session management. The procedures currently described are for the CC of circuit-switched connections, SM for GPRS services, MM and radio resource management for circuit-switched and GPRS services. MBMS is also added.

#### **1.2.2.2.115 TS 24.010**

##### **Mobile radio interface layer 3; Supplementary services specification; General aspects**

This specification describes the general aspects of the specification of supplementary services at the Layer 3 radio interface. Details are specified in other TSs.

**1.2.2.2.116 TS 24.011****Point-to-Point (PP) Short Message Service (SMS) support on mobile radio interface**

This specification describes the procedures used across the mobile radio interface by the signalling Layer 3 function short message control (SMC) and short message relay (SM-RL) function for both circuit-switched GSM and GPRS.

**1.2.2.2.117 TS 24.022****Radio Link Protocol (RLP) for circuit switched bearer and teleservices**

This specification describes the RLP for data transmission over the UMTS public land mobile network (PLMN). RLP covers the Layer 2 functionality of the ISO OSI reference model (IS 7498). It is based on ideas contained in IS 3309, IS 4335 and IS 7809 (HDLC of ISO) as well as ITU-T Recommendations X.25, Q.921 and Q.922 (LAP-B and LAP-D, respectively). RLP has been tailored to the special needs of digital radio transmission. RLP provides to its users the OSI data link service (IS 8886).

**1.2.2.2.118 TS 24.080****Mobile radio interface layer 3 supplementary services specification; Formats and coding**

This specification describes the coding of information necessary for support of supplementary service operation on the mobile radio interface L3. Details are specified in other TSs.

**1.2.2.2.119 TS 24.081****Line identification supplementary services; Stage 3**

This document specifies the procedures used at the radio interface for normal operation, registration, erasure, activation, deactivation, invocation and interrogation of line identification supplementary services. Provision and withdrawal of supplementary services is an administrative matter between the mobile subscriber and the service provider and cause no signalling on the radio interface.

**1.2.2.2.120 TS 24.082****Call Forwarding (CF) supplementary services; Stage 3**

This TS specifies the procedures used at the radio interface for: normal operation, registration, erasure, activation, deactivation, interrogation, and network invocation of the call offering supplementary services within the 3GPP system.

**1.2.2.2.121 TS 24.083****Call Waiting (CW) and Call Hold (HOLD) supplementary services; Stage 3**

This document specifies the procedures used at the radio interface (Reference point Um as defined in 3GPP TS 24.002) for normal operation, registration, erasure, activation, deactivation, invocation and interrogation of call completion supplementary services. Provision and withdrawal of supplementary services is an administrative matter between the mobile subscriber and the service provider and cause no signalling on the radio interface.

**1.2.2.2.122 TS 24.084****MultiParty (MPTY) supplementary service; Stage 3**

This document specifies the procedures used at the radio interface (Reference point Um as defined in 3GPP TS 24.002) for normal operation and invocation of MultiParty supplementary services.

**1.2.2.2.123 TS 24.085****Closed User Group (CUG) supplementary service; Stage 3**

This technical specification (TS) for mobile communications specifies the procedures used at the radio interface (reference point Um as defined in 3GPP TS 24.002) for normal operation, registration, erasure, activation, deactivation, invocation and interrogation of community of interest supplementary services. The provision and withdrawal of supplementary services is an administrative matter between the mobile subscriber and the service provider and causes no signalling on the radio interface.

**1.2.2.2.124 TS 24.086****Advice of Charge (AoC) supplementary services; Stage 3**

This document specifies the procedures used at the radio interface (reference point Um as defined in 3GPP TS 24.002) for normal operation, registration, erasure, activation, deactivation, invocation and interrogation of charging supplementary services. The provision and withdrawal of supplementary services is an administrative matter between the mobile subscriber and the service provider and causes no signalling on the radio interface.

**1.2.2.2.125 TS 24.087****User-to-User Signalling (UUS); Stage 3**

This technical specification gives the stage 3 description of the User-to-User signalling supplementary services.

**1.2.2.2.126 TS 24.088****Call Barring (CB) supplementary service; Stage 3**

This technical specification (TS) specifies the procedures used at the radio interface (reference point Um as defined in 3GPP TS 24.002) for normal operation, registration, erasure, activation, deactivation, invocation and interrogation of call barring supplementary services. Provision and withdrawal of supplementary services is an administrative matter between the mobile subscriber and the service provider and cause no signalling on the radio interface.

**1.2.2.2.127 TS 24.090****Unstructured Supplementary Service Data (USSD); Stage 3**

This document gives the stage 3 description of the Unstructured Supplementary Service Data (USSD) operations.

**1.2.2.2.128 TS 24.091****Explicit Call Transfer (ECT) supplementary service; Stage 3**

This document gives the stage 3 description of the call transfer supplementary services. This document specifies the procedures used at the radio interface (Reference point Um as defined in 3GPP TS 24.002) for normal operation, registration, erasure, activation, deactivation, invocation and interrogation of call transfer supplementary services. Provision and withdrawal of supplementary services is an administrative matter between the mobile subscriber and the service provider and cause no signalling on the radio interface. In 3GPP TS 24.010 the general aspects of the specification of supplementary services at the layer 3 radio interface are given.

**1.2.2.2.129 TS 24.093****Call Completion to Busy Subscriber (CCBS); Stage 3**

This document gives the stage 3 description of the Completion of Calls to Busy Subscriber (CCBS) supplementary service. This document specifies the procedures used at the radio interface (Reference point Um as defined in 3GPP TS 24.002) for normal operation, activation, deactivation, invocation and interrogation of the completion of calls to busy subscriber supplementary services. Provision and withdrawal of supplementary services is an administrative matter between the mobile subscriber and the service provider and cause no signalling on the radio interface.

**1.2.2.2.130 TS 24.096****Name identification supplementary services; Stage 3**

This technical specification (TS) specifies the procedures used at the radio interface for normal operation, registration, erasure, activation, deactivation, invocation and interrogation of name identification supplementary services. Provision and withdrawal of supplementary services is an administrative matter between the mobile subscriber and the service provider and cause no signalling on the radio interface. In 3GPP TS 24.010 the general aspects of the specification of supplementary services at the layer 3 radio interface are given. 3GPP TS 24.080 specifies the formats and coding for the supplementary services.

**1.2.2.2.131 TS 24.103****Telepresence using the IP Multimedia (IM) Core Network (CN) Subsystem (IMS); Stage 3**

This document provides the protocol details for telepresence using the IP Multimedia (IM) Core Network (CN) subsystem based on the Session Initiation Protocol (SIP), the Session Description Protocol (SDP), the Binary Floor Control Protocol (BFCP) and the ControLLing mUltiple streams for tElepresence (CLUE) controlling multiple streams for telepresence based on service requirements.

This document addresses the areas of describing and negotiating IM session with multiple media streams based on the IM CN subsystem, including point to point calls as specified in 3GPP TS 24.229 and multiparty conferences as specified in 3GPP TS 24.147, to facilitate the support of telepresence.

The functionalities for conference policy control and the signalling between a MRFC and a MRFP are not specified in this document.

Where possible, this document specifies the requirements for this protocol by reference to specifications produced by the IETF within the scope of SIP, SDP, CLUE and BFCP, either directly, or as modified by 3GPP TS 24.229.

The present document is applicable to Application Servers (ASs), Multimedia Resource Function Controllers (MRFCs), Multimedia Resource Function Processors (MRFP) and User Equipment (UE) providing IM session supporting telepresence capabilities.

**1.2.2.2.132 TS 24.139****3GPP system – fixed broadband access network interworking; Stage 3**

This document specifies the UE – EPC procedures for accessing 3GPP Evolved Packet Core (EPC) via a Fixed Broadband Access network. The specification covers the Support of QoS, Tunnel management procedures including the support of NAT traversal, and non-seamless offloading impacts. The document is applicable to the UE and the network (i.e. the 3GPP EPC).

**1.2.2.2.133 TS 24.141****Presence service using the IP Multimedia (IM) Core Network (CN) subsystem; Stage 3**

This specification provides the protocol details for the presence service within the IP Multimedia (IM) Core Network (CN) subsystem based on the Session Initiation Protocol (SIP) and SIP Events as defined in 3GPP TS 24.229.

**1.2.2.2.134 TS 24.147****Conferencing using the IP Multimedia (IM) Core Network (CN) subsystem; Stage 3**

This specification provides the protocol details for conferencing within the IP Multimedia Core Network subsystem (IMS) based on the Session Initiation Protocol (SIP), SIP Events, the Session Description Protocol (SDP) and the Binary Floor Control Protocol (BFCP).

**1.2.2.2.135 TS 24.166****3GPP IP Multimedia Subsystem (IMS) conferencing Management Object (MO)**

This document defines the IMS conferencing management object. The management object is compatible with OMA Device Management protocol specifications, version 1.2 and upwards, and is defined using the OMA DM Device Description Framework as described in the Enabler Release Definition OMA-ERELED\_DM-V1\_2.

**1.2.2.2.136 TS 24.167****3GPP IMS Management Object (MO); Stage 3**

This document defines a mobile device 3GPP IMS Management Object. The management object is compatible with OMA Device Management protocol specifications, version 1.2 and upwards, and is defined using the OMA DM Device Description Framework as described in the Enabler Release Definition OMA-ERELED\_DM-V1\_2.

**1.2.2.2.137 TS 24.171****Control Plane Location Services (LCS) procedures in the Evolved Packet System (EPS)**

This document specifies the operations and information coding for the Non-access Stratum (NAS) layer protocol for supporting the Location Services (LCS) in the Evolved Universal Terrestrial Radio Access Network (E-UTRAN).

**1.2.2.2.138 TS 24.173****IMS multimedia telephony communication service and supplementary services; Stage 3**

This specification provides the protocol details for multimedia telephony communication service and associated supplementary services in the IP Multimedia (IM) Core Network (CN) subsystem based on the requirements from 3GPP TS 22.173. Multimedia telephony and supplementary services allow users to establish communications between them and enrich that by enabling supplementary services.

**1.2.2.2.139 TS 24.182****IP Multimedia Subsystem (IMS) Customized Alerting Tones (CAT); Protocol specification**

This document provides the protocol details for the Customized Alerting Tones (CAT) service in the IP Multimedia (IM) Core Network (CN) subsystem based on the requirements from 3GPP TS 22.182. The CAT service is an operator specific service by which an operator enables the subscriber to customize the media which is played to the calling party during alerting of the called party. This

document is applicable to User Equipment (UE) and Application Servers (AS) which are intended to support the CAT service.

#### **1.2.2.2.140 TS 24.183**

##### **IP Multimedia Subsystem (IMS) Customized Ringing Signal (CRS); Protocol specification**

The specification provides the protocol details for the Customized Ringing Signal (CRS) service in the IP Multimedia (IM) Core Network (CN) subsystem based on the requirements from 3GPP TS 22.183. The CRS service is an operator specific service by which an operator enables the subscriber to customize the media which is played to the called party as an incoming communication indication during establishment of a communication. This document is applicable to User Equipment (UE) and Application Servers (AS) which are intended to support the CRS service.

#### **1.2.2.2.141 TS 24.216**

##### **Communication Continuity Management Object (MO)**

The Communication Continuity Management Object consists of relevant parameters that can be managed for Communication Continuity capabilities.

#### **1.2.2.2.142 TS 24.229**

##### **IP multimedia call control protocol based on Session Initiation Protocol (SIP) and Session Description Protocol (SDP); Stage 3**

This specification defines a call control protocol for use in the IP Multimedia (IM) Core Network (CN) subsystem based on the Session Initiation Protocol (SIP), and the associated Session Description Protocol (SDP).

#### **1.2.2.2.143 TS 24.234**

##### **3GPP system to Wireless Local Area Network (WLAN) interworking; WLAN User Equipment (WLAN UE) to network protocols; Stage 3**

The document specifies the network selection, including authentication and access authorization using authentication, authorization and accounting (AAA) procedures used for the interworking of the 3GPP system and WLANs. In addition to these it also specifies the tunnel management procedures used for establishing an end-to-end tunnel from the WLAN UE to the 3GPP network via the Wu reference point. The document is applicable to the WLAN user equipment (UE) and the network. In this technical specification the network includes the WLAN and 3GPP network.

Furthermore, the document specifies procedures within I-WLAN necessary in order for IMS emergency calls to be supported when I-WLAN is used as the underlying access network. These involve both network selection as well as tunnel management procedures.

#### **1.2.2.2.144 TS 24.235**

##### **3GPP System to Wireless Local Area Network (WLAN) interworking Management Object (MO)**

This document defines the 3GPP System to Wireless Local Area Network interworking Management Object (MO) for I-WLAN PLMN selection as specified in 3GPP TS 24.234. The 3GPP System to Wireless Local Area Network interworking Management Object consists of relevant parameters that can be managed for WLAN UE as specified in 3GPP TS 24.234.

**1.2.2.2.145 TS 24.237****IP Multimedia (IM) Core Network (CN) subsystem IP Multimedia Subsystem (IMS) service continuity; Stage 3**

This specification provides the capability of continuing ongoing communication sessions with multiple media across different access networks. This document provides the protocol details for enabling IMS SC based on the Session Initiation protocol (SIP) and the Session Description Protocol (SDP) and the protocols of the 3GPP Circuit-Switched (CS) domain (e.g. CAP, MAP, ISUP, BICC and the NAS call control protocol for the CS access).

**1.2.2.2.146 TS 24.238****Session Initiation Protocol (SIP) based user configuration; Stage 3**

This document provides a Session Initiation Protocol (SIP) based protocol framework that serves as a means of user configuration of supplementary services in the IP Multimedia (IM) Core Network (CN) subsystem. The protocol framework relies upon the contents of the Request-URI in a SIP INVITE request to enable basic configuration of services without requiring use of the Ut interface. This document is applicable to User Equipment (UE) and Application Servers (AS) which are intended to support user configuration of supplementary services.

**1.2.2.2.147 TS 24.239****Flexible Alerting (FA) using IP Multimedia (IM) Core Network (CN) subsystem; Protocol specification**

This document provides the protocol details for the Flexible Alerting supplementary service in the IP Multimedia (IM) Core Network (CN) subsystem. Flexible Alerting (FA) causes a call to a pilot identity to branch the call into several legs to alert several termination addresses (group members) simultaneously. The first leg to be answered is connected to the calling party.

The other call legs are abandoned. The document is applicable to User Equipment (UE) and Application Servers (AS) which are intended to support the FA supplementary service.

**1.2.2.2.148 TS 24.244****Wireless LAN control plane protocol for trusted WLAN access to EPC; Stage 3**

This document specifies the procedures of the Wireless LAN control plane protocol (WLCP) for trusted WLAN access to EPC which is used between User Equipment (UE) and Trusted WLAN Access Gateway (TWAG) for multi-connection mode as specified in 3GPP TS 23.402.

This document also defines the message format, information elements coding, error handling and system parameters applied by the WLCP protocol.

**1.2.2.2.149 TS 24.247****Messaging service using the IP Multimedia (IM) Core Network (CN) subsystem; Stage 3**

This specification provides the protocol details for the messaging service within the IP Multimedia CN Subsystem (IMS) based on the Session Initiation Protocol (SIP), the Session Description Protocol (SDP) and, the Message Session Relay Protocol (MSRP).

**1.2.2.2.150 TS 24.259****Personal Network Management (PNM); Stage 3**

This specification provides the protocol details for enabling Personal Network management services in the IP Multimedia Core Network subsystem based on the protocols of SIP and the SDP. This document is applicable to UEs and AS providing PNM capabilities.

**1.2.2.2.151 TS 24.279****Combining Circuit Switched (CS) and IP Multimedia Subsystem (IMS) services; Stage 3**

This specification provides the technical realization for the combination of Circuit Switched calls and IM sessions when using them simultaneously between the same two users. It also describes the use of CS and IM services in combination, using the existing procedures that have been defined for CS and IMS. It includes the necessary function as adding an IM session to an ongoing CS call, adding a CS call to an ongoing IM session, supplementary services as they relate to CSICS and supporting capability exchange.

**1.2.2.2.152 TS 24.285****Allowed Closed Subscriber Group (CSG) list; Management Object (MO)**

The Allowed CSG List MO consists of relevant parameters for that can be used by the UE to select the appropriate CSG cell based on its subscription. The Allowed CSG List MO defines the relevant parameters related to the Allowed CSG List and to the Operator CSG List.

**1.2.2.2.153 TS 24.286****IP Multimedia (IM) Core Network (CN) subsystem Centralized Services (ICS); Management Object (MO)**

This document defines the IMS Centralized Services Management Object (MO). The management object is compatible with OMA Device Management protocol specifications, version 1.2 and upwards, and is defined using the OMA DM Device Description Framework as described in the Enabler Release Definition OMA-ERELED\_DM-V1\_2.

**1.2.2.2.154 TS 24.292****IP Multimedia (IM) Core Network (CN) subsystem Centralized Services (ICS); Stage 3**

IP Multimedia (IM) Core Network (CN) subsystem centralized services (ICS) allow for the delivery of consistent IMS services to the user regardless of the attached access type (e.g. CS domain access or IP-CAN). This specification provides the protocol details for the realization of ICS based on the Session Initiation protocol (SIP), the Session Description Protocol (SDP) and the protocols of the 3GPP Circuit-Switched (CS) domain (e.g. CAP, MAP, ISUP, BICC and the NAS call control protocol for the CS access).

**1.2.2.2.155 TS 24.294****IP Multimedia Subsystem (IMS) Centralized Services (ICS) protocol via I1 interface**

This document describes the I1 interface between IMS Centralized Services (ICS) UE and Service Centralization and Continuity (SCC) Application Server (AS).



**1.2.2.2.156 TS 24.301****Non-Access-Stratum (NAS) protocol for Evolved Packet System (EPS); Stage 3**

This specification specifies the procedures used by the protocols for mobility management and session management between User Equipment (UE) and Mobility Management Entity (MME) in the Evolved Packet System (EPS). These protocols belong to the non-access stratum (NAS). The EPS Mobility Management (EMM) protocol defined in this document provides procedures for the control of mobility when the User Equipment (UE) is using the Evolved UMTS Terrestrial Radio Access Network (E-UTRAN). The EMM protocol also provides control of security for the NAS protocols. The EPS Session Management (ESM) protocol defined in this document provides procedures for the handling of EPS bearer contexts. Together with the bearer control provided by the access stratum, this protocol is used for the control of user plane bearers. For both NAS protocols this document specifies procedures for the support of inter-system mobility between E-UTRAN and other 3GPP or non-3GPP access networks.

**1.2.2.2.157 TS 24.302****Access to the 3GPP Evolved Packet Core (EPC) via non-3GPP access networks; Stage 3**

This document specifies the discovery and network selection procedures for access to 3GPP Evolved Packet Core (EPC) via non-3GPP access networks and includes Authentication and Access Authorization using Authentication, Authorization and Accounting (AAA) procedures used for the interworking of the 3GPP EPC and the non-3GPP access networks. This document also specifies the Tunnel management procedures used for establishing an end-to-end tunnel from the UE to the ePDG to the point of obtaining IP connectivity and includes the selection of the IP mobility mode.

**1.2.2.2.158 TS 24.303****Mobility management based on Dual-Stack Mobile IPv6; Stage 3**

This document specifies the signalling procedures for accessing the 3GPP Evolved Packet Core network and handling the mobility between 3GPP and non-3GPP accesses via the S2c reference point defined in 3GPP TS 23.402. In addition this document specifies the procedures used for the DSMIPv6 Home Agent discovery, for bootstrapping the DSMIPv6 security association between the UE and the Home Agent and for managing the DSMIPv6 tunnel. DSMIPv6 procedures can be used independently of the underlying access technology.

**1.2.2.2.159 TS 24.304****Mobility management based on Mobile IPv4; User Equipment (UE) – foreign agent interface; Stage 3**

This document describes the stage 3 aspects of mobility management for User Equipment (UE) using IETF Mobile IPv4 foreign agent mode to access the Evolved Packet Core Network (EPC) through trusted non-3GPP access networks and for mobility management of UE between the 3GPP access network and trusted non-3GPP access networks. In particular, this document describes the UE – Mobile IPv4 Foreign Agent (FA) interface stage 3 aspects, where the FA functionality is located within the access network in the non-3GPP access domain.

**1.2.2.2.160 TS 24.305****Selective Disabling of 3GPP User Equipment Capabilities (SDoUE) Management Object (MO)**

This document specifies a mobile device Selective Disabling of 3GPP UE Capabilities (SDoUE) Management Object (MO) and the rules and corresponding behaviour of the UE with regard to the

selective disabling of 3GPP UE capabilities, for example, when services or functions are disabled/enabled.

The SDoUE MO consists of the relevant parameters that can be managed for selective disabling of 3GPP UE capabilities. The SDoUE MO defines a repository of data into the ME. The service requirements for selective disabling of 3GPP UE capabilities are defined in 3GPP TS 22.011.

#### **1.2.2.2.161 TS 24.312**

##### **Access Network Discovery and Selection Function (ANDSF) Management Object (MO)**

This document defines management objects that can be used by the Access Network Discovery and Selection Function (ANDSF) and the UE. The Management Object (MO) is compatible with the OMA Device Management (DM) protocol specifications, version 1.2 and upwards, and is defined using the OMA DM Device Description Framework (DDF) as described in the Enabler Release Definition OMA-ERELED-DM-V1\_2.

#### **1.2.2.2.162 TS 24.315**

##### **IP Multimedia Subsystem (IMS) Operator Determined Barring (ODB); Stage 3: protocol specification**

This document specifies the stage three, Protocol Description of the network feature Operator Determined Barring (ODB) of IMS Multimedia Telephony Services. It is based on the requirements described in 3GPP TS 22.041. It provides the protocol details in the IP Multimedia (IM) Core Network (CN) subsystem based on the Session Initiation Protocol (SIP) and the Session Description Protocol (SDP). In addition, it provides protocol details for XCAP for barring of supplementary services configuration.

#### **1.2.2.2.163 TS 24.322**

##### **Tunnelling of IP Multimedia Subsystem (IMS) services over restrictive access networks; Stage 3**

This document specifies procedures and protocol elements for tunnelling of IMS traffic over restrictive access networks, specifically procedures and protocol elements for establishing, maintaining, and sending traffic via a firewall traversal tunnel between the UE and an enhanced firewall traversal function (EFTF) in the network. This document is applicable to UE and EFTF.

This document applies only to the case when the IMS traffic is not routed via EPC of a PLMN. Procedures for tunnelling of IMS traffic that is routed via EPC are specified in 3GPP TS 24.302 annex F.

#### **1.2.2.2.164 TS 24.327**

##### **Mobility between 3GPP Wireless Local Area Network (WLAN) interworking (I-WLAN) and 3GPP systems; General Packet Radio System (GPRS) and 3GPP I-WLAN aspects; Stage 3**

This document specifies the signalling procedures for handling the mobility of a UE between 3GPP Wireless Local Area Network Interworking (I-WLAN) and GPRS systems and is applicable to the User Equipment (UE) and the network nodes supporting mobility between 3GPP I-WLAN and GPRS systems. In addition, it specifies the procedures used between the UE and the network nodes for the attach and the detach cases. It also specifies how the UE performs handover when moving from 3GPP I-WLAN to GPRS systems and vice-versa.

**1.2.2.2.165 TS 24.333****Proximity-services (ProSe) Management Objects (MO)**

This document defines Management Objects (MO) that are used to configure the ProSe-enabled UE. The MOs are compatible with the OMA Device Management (DM) protocol specifications, version 1.2 and upwards, and are defined using the OMA DM Device Description Framework (DDF) as described in the Enabler Release Definition OMA-ERELED-DM-V1\_2.

The MOs consist of relevant parameters for provisioning and authorisation of ProSe at the ProSe-enabled UE.

The protocol aspects for ProSe are described in 3GPP TS 24.334.

**1.2.2.2.166 TS 24.334****Proximity-services (ProSe) User Equipment (UE) to ProSe function protocol aspects; Stage 3**

This document specifies the protocols for Proximity-based Services (ProSe) between:

- the ProSe-enabled UE and the ProSe Function (over the PC3 interface); and
- two ProSe-enabled UEs (over the PC5 interface).

This document defines the associated procedures for ProSe service authorisation, ProSe direct discovery, EPC-level ProSe discovery, and EPC support for WLAN direct discovery and communication.

This document also defines the message format, message contents, error handling and system parameters applied by the protocols for ProSe.

This document is applicable to:

- the ProSe-enabled UE; and
- the ProSe Function.

**1.2.2.2.167 TS 24.337****IP Multimedia (IM) Core Network (CN) subsystem IP Multimedia Subsystem (IMS) Inter-UE transfer; Stage 3**

This document provides the protocol details for enabling IMS inter-UE transfer based on the Session Initiation protocol (SIP) and the Session Description Protocol (SDP).

**1.2.2.2.168 TS 24.341****Support of SMS over IP networks; Stage 3**

This document provides the protocol details for SMS over IP within the IP Multimedia (IM) Core Network (CN) subsystem based on the Session Initiation Protocol (SIP) and SIP Events as defined in 3GPP TS 24.229. Where possible this document specifies the requirements for this protocol by reference to specifications produced by the IETF within the scope of SIP and SIP Events, either directly, or as modified by 3GPP TS 24.229. This document is applicable to Application Servers (ASs) and User Equipment (UE) providing SMS over IP functionality.

**1.2.2.2.169 TS 24.368****Non-Access Stratum (NAS) Management Object (MO)**

This document defines a Management Object (MO) that can be used to configure the UE with parameters related to Non-Access Stratum (NAS) functionality.

**1.2.2.2.170 TS 24.371****Web Real-Time Communications (WebRTC) client access to the IP Multimedia (IM) Core Network (CN) subsystem; Protocol specification**

The present document provides the details for allowing Web Real-Time Communication (WebRTC) IMS Clients (WIC) to access the IP Multimedia (IM) Core Network (CN) subsystem.

The present document is applicable to WebRTC IMS client (WIC), eP-CSCF, WebRTC Web Server Function (WWSF) and WebRTC Authorization Function (WAF).

**1.2.2.2.171 TS 24.390****Unstructured Supplementary Service Data (USSD) using IP Multimedia (IM) Core Network (CN) subsystem IMS; Stage 3**

This document describes the procedures for using Unstructured Supplementary Service Data (USSD) operations for mobile initiated MMI mode over IP Multimedia Core Network Subsystem (IMS). MMI mode is for the transparent transport of MMI strings entered by the user to the Application Servers (AS) and for the transparent transport of text strings back to the User Equipment (UE) to be displayed for user information. Support of USSD service is optional and only applicable for an operator's Public Land Mobile Network (PLMN). This document is applicable to UE and AS which are intended to support USSD operations over IP Multimedia Core Network Subsystem (IMS) in mobile initiated MMI mode.

**1.2.2.2.172 TS 24.391****Unstructured Supplementary Service Data (USSD) using IP Multimedia (IM) Core Network (CN) subsystem (IMS) Management Object (MO)**

This document defines the unstructured supplementary service data (USSD) using IP Multimedia (IM) Core Network (CN) subsystem (IMS) management object (MO). The MO is compatible with OMA device management protocol specifications, version 1.2 and upwards, and is defined using the OMA DM device description framework as described in the enabler release definition OMA-ERELED\_DM-V1\_2.

The USSD using IMS (USSI) MO consists of relevant configuration parameters that can be managed for the UE's USSI capabilities specified in 3GPP TS 24.390.

**1.2.2.2.173 TS 24.523****Core and enterprise Next Generation Network (NGN) interaction scenarios; Architecture and functional description**

This document provides the possible scenarios for:

- the interconnection of an Next Generation Corporate Network (NGCN) with a Next Generation Network (NGN); and
- the support of NGCN capabilities within an NGN, either towards a User Equipment (UE) or to an NGCN.

Unless otherwise specified by reference to other documents, all requirements relating to architecture and functional requirements are contained within this document.

**1.2.2.2.174 TS 24.524****Hosted enterprise services; Architecture, functional description and signalling**

This document describes the architecture and functionality required to support enterprise and corporate services as IMS applications hosted in the NGN operator's network on behalf of an enterprise (Hosted Enterprise Services).

This document also specifies the protocol requirements for the UE to attach to the NGN (in particular the IMS) and also any protocol requirements related to application servers provided in support of hosted enterprise services.

**1.2.2.2.175 TS 24.525****Business trunking; Architecture and functional description**

This document provides architecture and functional requirements for business trunking for the Next Generation Network (NGN).

This document also specifies the protocol requirements for the Next Generation Corporate Networks (NGCNs) to attach to the NGN (in particular the IM CN subsystem) and also any protocol requirements relation to application servers provided in support of business trunking.

Business trunking is a set of NGN capabilities that may be applied to communications between NGCNs using the NGN as a transit.

**1.2.2.2.176 TS 24.604****Communication Diversion (CDIV) using IP Multimedia (IM) Core Network (CN) subsystem; Protocol specification**

This document specifies the stage 3, Protocol Description of the Communications Diversion (CDIV) supplementary services, based on stage one and two of the ISDN Communication diversion supplementary services. It provides the protocol details in the IP Multimedia (IM) Core Network (CN) subsystem based on the Session Initiation Protocol (SIP) and the Session Description Protocol (SDP).

**1.2.2.2.177 TS 24.605****Conference (CONF) using IP Multimedia (IM) Core Network (CN) subsystem; Protocol specification**

This document specifies the stage three Protocol Description of the Conference (CONF) service based on stage one and two of the ISDN CONF supplementary service. It provides the protocol details in the IP Multimedia (IM) Core Network (CN) subsystem based on the Session Initiation Protocol (SIP) and the Session Description Protocol (SDP).

**1.2.2.2.178 TS 24.606****Message Waiting Indication (MWI) using IP Multimedia (IM) Core Network (CN) subsystem; Protocol specification**

This document specifies the stage three Protocol Description of the Message Waiting Indication (MWI) service, based on stage one and two of the ISDN MWI supplementary services. It provides the protocol details in the IP Multimedia (IM) Core Network (CN) subsystem based on the Session Initiation Protocol (SIP) and the Session Description Protocol (SDP).

**1.2.2.2.179 TS 24.607****Originating Identification Presentation (OIP) and Originating Identification Restriction (OIR) using IP Multimedia (IM) Core Network (CN) subsystem; Protocol specification**

This document specifies the stage three (protocol description) of the Originating Identification Presentation (OIP) supplementary service and the Originating Identification Restriction (OIR) supplementary services, based on stage one and two of the ISDN CLIP and CLIR supplementary service. It provides the protocol details in the IP Multimedia (IM) Core Network (CN) subsystem based on the Session Initiation Protocol (SIP) and the Session Description Protocol (SDP).

**1.2.2.2.180 TS 24.608****Terminating Identification Presentation (TIP) and Terminating Identification Restriction (TIR) using IP Multimedia (IM) Core Network (CN) subsystem; Protocol specification**

This document specifies the stage three protocol description of the Terminating Identification Presentation (TIP) and Terminating Identification Restriction (TIR) services, based on stage one and two of the ISDN COLP and COLR supplementary services. It provides the protocol details in the IP Multimedia (IM) Core Network (CN) subsystem based on the Session Initiation Protocol (SIP) and the Session Description Protocol (SDP).

**1.2.2.2.181 TS 24.610****Communication HOLD (HOLD) using IP Multimedia (IM) Core Network (CN) subsystem; Protocol specification**

This document specifies the stage three Protocol Description of the Communication Hold (HOLD) services, based on stages one and two of the ISDN Hold (HOLD) supplementary services. It provides the protocol details in the IP Multimedia (IM) Core Network (CN) subsystem based on the Session Initiation Protocol (SIP) and the Session Description Protocol (SDP).

**1.2.2.2.182 TS 24.611****Anonymous Communication Rejection (ACR) and Communication Barring (CB) using IP Multimedia (IM) Core Network (CN) subsystem; Protocol specification**

This document specifies the stage three, Protocol Description of the Anonymous Communication Rejection (ACR) and Communication Barring (CB) supplementary service, based on stage one and two of the ISDN supplementary service Anonymous Call Rejection (ACR), Incoming Communication Barring (ICB) and Outgoing Communication Barring (OCB). It provides the protocol details in the IP Multimedia (IM) Core Network (CN) subsystem based on the Session Initiation Protocol (SIP) and the Session Description Protocol (SDP).

**1.2.2.2.183 TS 24.615****Communication Waiting (CW) using IP Multimedia (IM) Core Network (CN) subsystem; Protocol specification**

This document specifies the stage 3, Protocol Description of the Communication Waiting (CW) service, based on stage 1 and stage 2 of the ISDN call waiting supplementary services. It provides the protocol details in the IP Multimedia (IM) Core Network (CN) subsystem based on the Session Initiation Protocol (SIP) and the Session Description Protocol (SDP).

**1.2.2.2.184 TS 24.616****Malicious Communication Identification (MCID) using IP Multimedia (IM) Core Network (CN) subsystem; Protocol specification**

This document specifies the stage three Protocol Description of the Malicious Call Communication Identification (MCID) service based on the stage one and two of ISDN Malicious Call Identification supplementary service. It provides the protocol details in the IP Multimedia (IM) Core Network (CN) subsystem based on the Session Initiation Protocol (SIP) and the Session Description Protocol (SDP). The MCID service will store session related information independent of the service requested.

**1.2.2.2.185 TS 24.623****Extensible Markup Language (XML) Configuration Access Protocol (XCAP) over the Ut interface for manipulating supplementary services**

This document defines a protocol used for manipulating data related to supplementary services. The protocol is based on the eXtensibleMarkup Language (XML) Configuration Access Protocol (XCAP) RFC 4825. A new XCAP application usage is defined for the purpose of manipulating the supplementary services data. The common XCAP related aspects that are applicable to supplementary services are specified in this document. The protocol allows authorized users to manipulate service-related data either when they are connected to IMS or when they are connected to non-IMS networks (e.g. the public Internet).

**1.2.2.2.186 TS 24.628****Common Basic Communication procedures using IP Multimedia (IM) Core Network (CN) subsystem; Protocol specification**

This document describes the stage three protocol for basic communication procedures common to several services in the IP Multimedia (IM) Core Network (CN) subsystem when at least one Application Server (AS) is included in the communication. The common procedures are based on stage three specifications for supplementary services.

**1.2.2.2.187 TS 24.629****Explicit Communication Transfer (ECT) using IP Multimedia (IM) Core Network (CN) subsystem; Protocol specification**

This document specifies the stage three (protocol description) of the Explicit Communication transfer (ECT) supplementary service, based on stage one and two of the ISDN ECT supplementary service. It provides the protocol details in the IP Multimedia (IM) Core Network (CN) subsystem based on the Session Initiation Protocol (SIP) and the Session Description Protocol (SDP).

**1.2.2.2.188 TS 24.642****Completion of Communications to Busy Subscriber (CCBS) and Completion of Communications by No Reply (CCNR) using IP Multimedia (IM) Core Network (CN) subsystem; Protocol specification**

This document specifies the stage three Protocol Description of the Completion of Communications to Busy Subscriber (CCBS) service and the Completion of Communication on no Reply (CCNR) service, based on stage one and two of the ISDN supplementary services. It provides the protocol details in the IP Multimedia (IM) Core Network (CN) subsystem based on the Session Initiation Protocol (SIP) and the Session Description Protocol (SDP).

**1.2.2.2.189 TS 24.647****Advice Of Charge (AOC) using IP Multimedia (IM) Core Network (CN) subsystem**

This document specifies the stage three Protocol Description of the Advice Of Charge (AOC) service, based on stage 1 and 2 of the ISDN Supplementary Service Advice Of Charge for all calls (permanent mode). It provides the protocol details in the IP Multimedia (IM) Core Network (CN) subsystem based on the Session Initiation Protocol (SIP) and the Session Description Protocol (SDP).

**1.2.2.2.190 TS 24.654****Closed User Group (CUG) using IP Multimedia (IM) Core Network (CN) subsystem, Protocol specification**

This document specifies the stage three Protocol Description of the Closed User Group (CUG) service, based on stage one and two of the ISDN Communication diversion supplementary services. It provides the protocol details in the IP Multimedia (IM) Core Network (CN) subsystem based on the Session Initiation Protocol (SIP) and the Session Description Protocol (SDP).

**1.2.2.2.191 TS 26.071****AMR speech codec: general description**

This specification describes an introduction to the set of the adaptive multi-rate (AMR) specifications.

**1.2.2.2.192 TS 26.090****AMR speech codec: transcoding functions**

This specification describes a detailed description of the AMR speech codec transcoding functions.

**1.2.2.2.193 TS 26.091****AMR speech codec: error concealment of lost frames**

This specification describes example procedures for the error concealment, also called frame substitution or muting procedure, of lost speech or silence indicator frames.

**1.2.2.2.194 TS 26.092****AMR speech codec: comfort noise aspects**

This specification describes the detailed requirements for the correct operation of the background acoustic noise evaluation, noise parameter encoding/decoding and comfort noise generation for the AMR speech codec during source controlled rate (SCR) operation.

**1.2.2.2.195 TS 26.093****AMR speech codec: source controlled rate (SCR) operation**

This specification describes the operation of the AMR speech codec during SCR operation.

**1.2.2.2.196 TS 26.094****AMR speech codec: voice activity detector (VAD)**

This specification describes two alternatives for the VAD to be used during SCR operation in conjunction with the AMR codec.



**1.2.2.2.197 TS 26.110****Codec for circuit-switched multimedia telephony service: general description**

This specification describes an introduction to the set of specifications for the support of circuit-switched 3G-324M multimedia telephony service.

**1.2.2.2.198 TS 26.111****Codec for circuit-switched multimedia telephony service: modifications to Recommendation ITU-T H.324**

This specification describes the modifications applicable to the Recommendation ITU-T H.324, Annex C for the support of circuit-switched 3G-324M multimedia telephony service.

**1.2.2.2.199 TS 26.346****Multimedia Broadcast/Multicast Service (MBMS); Protocols and codecs**

This document defines a set of media codecs, formats and transport/application protocols to enable the deployment of MBMS user services either over the MBMS bearer service or other UMTS Bearer Services within the 3GPP system.

In this version of the specification, only MBMS download and streaming delivery methods are specified. This document does not preclude the use of other delivery methods.

This document includes information applicable to network operators, service providers and manufacturers.

**1.2.2.2.200 TS 26.441****Codec for Enhanced Voice Services (EVS); General overview**

This document is an introduction to the audio processing parts of the Enhanced Voice Services coder. A general overview of the audio processing functions is given, with reference to the documents where each function is specified in detail.

**1.2.2.2.201 TS 26.442****Codec for Enhanced Voice Services (EVS); ANSI C code (fixed-point)**

This document contains an electronic copy of the ANSI-C code for the Enhanced Voice Services (EVS) Codec. The ANSI-C code is necessary for a bit exact implementation of the EVS Codec (3GPP TS 26.445), Voice Activity Detection (VAD) (3GPP TS 26.451), Comfort Noise Generation (CNG) (3GPP TS 26.449), Discontinuous Transmission (DTX) (3GPP TS 26.450), Packet Loss Concealment (PLC) of Lost Packets (3GPP TS 26.447), Jitter Buffer Management (JBM) (3GPP TS 26.448), and AMR-WB Interoperable Function (3GPP TS 26.446).

**1.2.2.2.202 TS 26.444****Codec for Enhanced Voice Services (EVS); Test sequences**

This document specifies the digital test sequences for the Enhanced Voice Services (EVS) Codec. These sequences test for a bit-exact implementation of the EVS Codec (3GPP TS 26.445), Voice Activity Detection (VAD) (3GPP TS.26.451), Comfort Noise Generation (3GPP TS 26.449), Discontinuous Transmission (DTX) (3GPP TS 26.450), Error Concealment of Lost Packets (3GPP TS 26.447), Jitter Buffer Management (JBM) (3GPP TS 26.448), and AMR-WB Interoperable Function (3GPP TS 26.446).

**1.2.2.2.203 TS 26.445****Codec for Enhanced Voice Services (EVS); Detailed algorithmic description**

This document is a detailed description of the signal processing algorithms of the Enhanced Voice Services coder.

**1.2.2.2.204 TS 26.446****Codec for Enhanced Voice Services (EVS); Adaptive Multi-Rate - Wideband (AMR-WB) backward compatible functions**

This document specifies the AMR-WB backward compatible functions of the EVS codec.

This document is a high level overview of the functionality with reference to the Codec Detailed Algorithmic Description where the functionality is specified in detail.

**1.2.2.2.205 TS 26.447****Codec for Enhanced Voice Services (EVS); Error concealment of lost packets**

This document defines a frame loss concealment procedure, also termed frame substitution and muting procedure, which is executed by the Enhanced Voice Services (EVS) decoder when one or more frames (speech or audio or SID frames) are unavailable for decoding due to e.g. packet loss, corruption of a packet or late arrival of a packet.

**1.2.2.2.206 TS 26.448****Codec for Enhanced Voice Services (EVS); Jitter buffer management**

This document defines the Jitter Buffer Management solution for the Codec for Enhanced Voice Services (EVS).

**1.2.2.2.207 TS 26.449****Codec for Enhanced Voice Services (EVS); Comfort Noise Generation (CNG) aspects**

This document gives an overview for the requirements of the background acoustic noise evaluation, noise parameter encoding/decoding and comfort noise generation for the Enhanced Voice Services (EVS) speech codec during Discontinuous Transmission (DTX) operation.

**1.2.2.2.208 TS 26.450****Codec for Enhanced Voice Services (EVS); Discontinuous Transmission (DTX)**

This document specifies the system level aspects of the Discontinuous Transmission (DTX) function of the EVS codec.

**1.2.2.2.209 TS 26.451****Codec for Enhanced Voice Services (EVS); Voice Activity Detection (VAD)**

This document specifies the Voice Activity Detector (VAD) used in the Discontinuous Transmission (DTX) of the EVS Codec. Although the main application of the VAD algorithm is the detection of speech or voice signals, the algorithm is more accurately described as a Signal Activity Detection (SAD) algorithm.

This document is a high level overview of the functionality with reference to the Codec Detailed Algorithmic Description where the functionality is specified in detail.

**1.2.2.2.210 TS 27.005****Use of Data Terminal Equipment – Data Circuit terminating Equipment (DTE-DCE) interface for Short Message Service (SMS) and Cell Broadcast Service (CBS)**

This specification describes three interface protocols for control of SMS functions within a GSM mobile telephone from a remote terminal via an asynchronous interface.

**1.2.2.2.211 TS 27.007****AT command set for User Equipment (UE)**

This specification describes a profile of AT commands and recommends that this profile be used for controlling mobile equipment (ME) functions and GSM network services from a terminal equipment (TE) through terminal adaptor (TA).

**1.2.2.2.212 TS 27.010****Terminal Equipment to User Equipment (TE-UE) multiplexer protocol**

This specification describes a multiplexing protocol between a mobile station and an external data terminal for the purposes of enabling multiple channels to be established for different purposes (e.g. simultaneous SMS and data call).

**1.2.2.2.213 TS 28.390****Telecommunication management; Fixed Mobile Convergence (FMC); Interface Integration Reference Point (IRP) Solution Profiles (SPs)**

The objective of this specification is to define a set of Solution Profiles (SPs) for Interface IRPs. Each SP identifies the necessary and sufficient subset of the 3GPP IRP defined solutions (solutions) required for the network management of a specific operating environment or domain, including that defined for the converged management environments.

A specific operating environment or domain is characterised by a set of Requirement statements. In other words, the solutions identified in a specific SP would satisfy the Requirements listed in that same SP.

An SP, in its simplest form, is nothing else than a list of solutions (e.g. 3GPP IRP defined operations). The purpose is to place a combination of solutions under a common (SP) name so that:

- Operators and vendors need not decide arbitrarily which solutions are to be used to satisfy the Requirements;
- There is one document where readers can have a clear view of solutions, specified in various IRP specifications, required to satisfy the Requirements.

This version of the TS contains a number of SPs defined in clause 4 and onwards, one clause for each SP.

**1.2.2.2.214 TS 28.402****Telecommunication management; Performance Management (PM); Performance measurements for Evolved Packet Core (EPC) and non-3GPP access interworking system**

This document describes the measurements for EPC and non-3GPP access network interworking.

TS 32.401 describes Performance Management concepts and requirements.

This document is valid for all measurement types provided by an implementation of EPC and non-3GPP access Interworking System. Only measurement types that are specific to EPC and non-3GPP access interworking are defined within this documents. Vendor specific measurement types used in

EPC and non-3GPP access Interworking System are not covered. Instead, these could be applied according to manufacturer's documentation.

Measurements related to "external" technologies (such as ATM or IP) as described by "external" standards bodies (e.g. ITU-T or IETF) are only be referenced within this specification, wherever there is a need identified for the existence of such a reference.

The definition of the standard measurements is intended to result in comparability of measurement data produced in a multi-vendor network, for those measurement types that can be standardised across all vendors' implementations.

The structure of this document is as follows:

- Header 1: Network Element (e.g. measurements related to ePDG);
- Header 2: Measurement function (e.g. Tunnel establishment);
- Header 3: Measurements.

#### **1.2.2.2.215 TS 28.611**

##### **Telecommunication management; Evolved Packet Core (EPC) and non-3GPP access interworking system Network Resource Model (NRM) Integration Reference Point (IRP); Requirements**

This document describes the Network Resource Model (NRM) Integration Reference Point (IRP) requirements for the EPC and WLAN interworking system according to the structure defined in 3GPP TS 23.402 (e.g. ePDG, 3GPP AAA, etc).

#### **1.2.2.2.216 TS 28.612**

##### **Telecommunication management; Evolved Packet Core (EPC) and non-3GPP access interworking system Network Resource Model (NRM) Integration Reference Point (IRP); Information Service (IS)**

This document is an Integration Reference Point (IRP) named "Evolved Packet Core (EPC) and non-3GPP access interworking system Network resource Model (NRM) IRP; Information Service (IS)", through which an 'IRPAgent' (typically an Element Manager or Network Element) can communicate configuration management information to one or several 'IRPManagers' (typically Network Managers) concerning interworking network resources.

This document specifies the semantics and behaviour of Information Object Class (IOC) attributes and relations visible across the reference point in a protocol and technology neutral way. It does not define their syntax and encoding.

It reuses relevant parts of the generic NRM in 3GPP TS 28.622, either by direct reuse or sub-classing, and in addition to that defines specific IOCs in EPC and non-3GPP access interworking systems.

In order to access the information defined by this NRM, an interface IRP is needed, such as the Basic CM IRP IS (3GPP TS 32.602) or the Bulk CM IRP IS (3GPP TS 32.612). However, which interface IRP is applicable is outside the scope of the present document.

#### **1.2.2.2.217 TS 28.616**

##### **Telecommunication management; Evolved Packet Core (EPC) and non-3GPP access interworking system Network Resource Model (NRM) Integration Reference Point (IRP); Solution Set (SS) definitions**

This document is part of an Integration Reference Point (IRP) named Evolved Packet Core (EPC) and non-3GPP access Interworking System Network Resource Model (NRM) IRP, through which an

IRPAgent can communicate configuration management information to one or several IRPManagers concerning EPC and non-3GPP access interworking system resources. The EPC and non-3GPP access Interworking System NRM IRP comprises a set of specifications defining requirements, a protocol neutral information service and one or more solution sets.

This document specifies the solution sets for the EPC and non-3GPP access interworking system NRM IRP.

This solution set specification is related to 3GPP TS 28.612.

#### **1.2.2.2.218 TS 28.622**

##### **Telecommunication management; Generic Network Resource Model (NRM) Integration Reference Point (IRP); Information Service (IS)**

This document specifies the Generic network resource information that can be communicated between an IRPAgent and an IRPManager for telecommunication network management purposes, including management of converged networks.

This document specifies the semantics of information object class attributes and relations visible across the reference point in a protocol and technology neutral way. It does not define their syntax and encoding.

#### **1.2.2.2.219 TS 29.002**

##### **Mobile Application Part (MAP) specification**

It is necessary to transfer between entities of a Public Land Mobile Network (PLMN) information specific to the PLMN in order to deal with the specific behaviour of roaming Mobile Stations (MS)s. The Signalling System No. 7 specified by CCITT is used to transfer this information.

#### **1.2.2.2.220 TS 29.016**

##### **General Packet Radio Service (GPRS); Serving GPRS Support Node (SGSN) – Visitors Location Register (VLR); Gs interface network service specification**

This document specifies or references the subset of MTP and SCCP which is used for the reliable transport of BSSAP+ messages in the Gs interface. This document references the 3GPP TS 29.202 which specifies alternative transport layers that can be applied instead of the MTP. This document also specifies the SCCP addressing capabilities to be provided in the Gs interface. This document is divided into two main parts, clause 5 dealing with the use of MTP and clauses 6 and 7 dealing with the use of SCCP. Clause 5 of this document deals with the subset of the MTP that is required between an SGSN and a VLR. It is intended that this implementation of MTP is compatible with a full MTP implementation. Clause 4 references the 3GPP TS 29.202 which specifies alternatives to the MTP. The SCCP is used to provide message routing between the SGSN and the VLR. The SCCP routing principles specified in this document allow connecting one SGSN to several VLR. No segmentation at SCCP level is needed on the Gs interface. Only SCCP class 0 is used on the Gs interface. Clauses 6 and 7 identify the SCCP subset that should be used between an SGSN and a VLR.

#### **1.2.2.2.221 TS 29.018**

##### **General Packet Radio Service (GPRS); Serving GPRS Support Node (SGSN) – Visitors Location Register (VLR); Gs interface layer 3 specification**

This document specifies or references procedures used on the Serving GPRS Support Node (SGSN) to Visitors Location Register (VLR) interface for interoperability between GSM circuit switched services and GSM packet data services. This document specifies the layer 3 messages and procedures on the Gs interface to allow coordination between databases and to relay certain messages related to

GSM circuit switched services over the GPRS subsystem. The functional split between VLR and SGSN is defined in 3GPP TS 23.060. The required procedures between VLR and SGSN are defined in detail in this document.

#### **1.2.2.2.222 TS 29.060**

### **General Packet Radio Service (GPRS); GPRS Tunnelling Protocol (GTP) across the Gn and Gp interface**

This document defines the second version of GTP used on: the Gn and Gp interfaces of the General Packet Radio Service (GPRS); the Iu, Gn and Gp interfaces of the UMTS system.

#### **1.2.2.2.223 TS 29.061**

### **Interworking between the Public Land Mobile Network (PLMN) supporting packet based services and Packet Data Networks (PDN)**

This document defines the requirements for Packet Domain interworking between a:

- a) PLMN and PDN;
- b) PLMN and PLMN.

This document is valid for a PLMN in  $A/G_b$  mode as well as for a PLMN in  $I_u$  mode. If text applies only for one of these systems it is explicitly mentioned by using the terms “ $A/G_b$  mode” and “ $I_u$  mode”. Please note, that the A interface does not play any role in the scope of this document although the term “ $A/G_b$  mode” is used.

#### **1.2.2.2.224 TS 29.078**

### **Customized Applications for Mobile network Enhanced Logic (CAMEL) Phase 4; CAMEL Application Part (CAP) specification**

This document specifies the CAMEL Application Part (CAP) supporting the fourth phase of the network feature Customized Applications for Mobile network Enhanced Logic. CAP is based on a sub-set of the ETSI Core INAP CS-2 as specified by ETSI EN 301 140-1. Descriptions and definitions provided by ETSI EN 301 140-1 are directly referenced by this standard in the case no additions or clarifications are needed for the use in the CAP.

#### **1.2.2.2.225 TS 29.079**

### **Optimal media routing within the IP Multimedia Subsystem (IMS); Stage 3**

This document defines optional Optimal Media Routing (OMR) procedures that can be applied by entities in the IP Multimedia Subsystem (IMS) that control media resources and are capable of manipulating the Session Description Protocol (SDP).

#### **1.2.2.2.226 TS 29.118**

### **Mobility Management Entity (MME) – Visitor Location Register (VLR) SGs interface specification**

CS Fallback in the Evolved Packet System (EPS) enables the provisioning of CS-domain services (e.g. voice call, Location Services (LCS) or supplementary services) by reuse of CS infrastructure when the UE is served by E-UTRAN. Additionally, SMS delivery via the CS core network is realized without CS fallback. This document specifies the procedures and the SGs Application Part (SGsAP) messages used on the SGs interface between the Mobility Management Entity (MME) in the EPS and the Visitor Location Register (VLR), to allow location management coordination and to relay certain messages related to GSM circuit switched services over the EPS system. This document also specifies the use of Stream Control Transmission Protocol (SCTP) for the transport of SGsAP messages.

**1.2.2.2.227 TS 29.162****Interworking between the IM CN subsystem and IP networks**

The IM CN subsystem interworks with the external IP networks through the Mb reference point. This document details the interworking between the IM CN subsystem and external IP networks for IM service support. It addresses the issues of control plane interworking and, user plane interworking for specific interworking use cases.

**1.2.2.2.228 TS 29.163****Interworking between the IP Multimedia (IM) Core Network (CN) subsystem and Circuit Switched (CS) networks**

This document specifies the principles of interworking between the 3GPP IM CN subsystem and BICC/ISUP based legacy CS networks, in order to support IM basic voice, data and multimedia calls. This document addresses the areas of control and user plane interworking between the IM CN subsystem and CS networks through the network functions, which include the MGCF and IM-MGW. For the specification of control plane interworking, areas such as the interworking between SIP and BICC or ISUP are detailed in terms of the processes and protocol mappings required for the support of both IM originated and terminated voice and multimedia calls. Other areas addressed encompass the transport protocol and signalling issues for negotiation and mapping of bearer capabilities and QoS information.

**1.2.2.2.229 TS 29.164****Interworking between the 3GPP CS domain with BICC or ISUP as signalling protocol and external SIP-I networks**

This specification defines interworking procedures between a 3GPP CS domain which applies either BICC or ISUP as signalling protocol, and external networks that use SIP-I as signalling protocol. The document also describes the related interworking architecture. This specification also defines stage 2 procedures for the control of the MGW.

**1.2.2.2.230 TS 29.165****Inter-IMS Network to Network Interface (NNI)**

The objective of this document is to address the Inter-IMS Network to Network Interface (II-NNI) consisting of Ici and Izi reference points between IMS networks in order to support end-to-end service interoperability. This document will address the issues related to control plane signalling (3GPP usage of SIP and SDP protocols, required SIP headers) as well as other interconnecting aspects like security, numbering/naming/addressing and user plane issues as transport protocol, media and codecs actually covered in a widespread set of 3GPP specifications. A profiling of the Inter-IMS Network to Network Interface (II-NNI) is also provided.

**1.2.2.2.231 TS 29.168****Cell Broadcast Centre interfaces with the Evolved Packet Core; Stage 3**

This document specifies the procedures and the SBc Application Part (SBc-AP) messages used on the SBc-AP interface between the Mobility Management Entity (MME) and the Cell Broadcast Centre (CBC). This document supports the following functions. Warning Message Transmission function in the EPS.

**1.2.2.2.232 TS 29.171****Location Services (LCS); LCS Application Protocol (LCS-AP) between the Mobile Management Entity (MME) and Evolved Serving Mobile Location Centre (E-SMLC); SLs interface**

This document specifies the procedures and information coding for LCS Application Protocol (LCS-AP) that is needed to support the location services in E-UTRAN. The LCS-AP message set is applicable to the SLs interface between the E-SMLC and the MME. LCS-AP is developed in accordance to the general principles stated in 3GPP TS 23.271.

**1.2.2.2.233 TS 29.172****Location Services (LCS); Evolved Packet Core (EPC) LCS Protocol (ELP) between the Gateway Mobile Location Centre (GMLC) and the Mobile Management Entity (MME); SLg interface**

This document specifies the procedures and information coding for the EPC LCS Protocol (ELP) that is needed to support the location services in E-UTRAN. The ELP message set is applicable to the SLg interface between the MME and the GMLC. ELP is developed in accordance to the general principles stated in 3GPP TS 23.271.

**1.2.2.2.234 TS 29.173****Location Services (LCS); Diameter-based SLh interface for Control Plane LCS**

This document describes the Diameter-based SLh interface between the GMLC and the HSS defined for the Control Plane LCS in EPC.

**1.2.2.2.235 TS 29.201****Representational State Transfer (REST) reference point between Application Function (AF) and Protocol Converter (PC)**

This document describes the Representational State Transfer (REST) reference point, which is used to exchange application level session information between the Protocol Converter (PC) and the Application Function (AF). REST shall be used as an architectural style as appropriate.

**1.2.2.2.236 TS 29.202****Signalling system No. 7 (SS7) signalling transport in core network; Stage 3**

This document defines the possible protocol architectures for transport of SS7 signalling protocols in Core Network.

**1.2.2.2.237 TS 29.204****Signalling System No. 7 (SS7) security gateway; Architecture, functional description and protocol details**

This specification provides functional description of the SS7 Security Gateway. The document covers also network architecture, routing considerations, and protocol details.

**1.2.2.2.238 TS 29.205****Application of Q.1900 series to bearer-independent Circuit Switched (CS) core network architecture; Stage 3**

This document describes the protocols to be used when ITU-T Q.1902 “Bearer Independent Call Control” is used as call control protocol in a 3GPP Bearer Independent CS core network



3GPP TS 23.205. The Q.1902 operates between (G)MSC servers. The BICC architecture as described in ITU-T Q.1902 consists of a number of protocols. The following types of protocols are described: call control protocol, bearer control protocols and a resource control protocol for this architecture. The architecture complies with the requirements imposed by 3GPP TS 23.205 and TS 23.153.

#### **1.2.2.2.239 TS 29.212**

##### **Policy and charging control (PCC); Reference points**

This document provides the protocol specification related to the Gx, Gxx and Sd reference points.

#### **1.2.2.2.240 TS 29.213**

##### **Policy and charging control signalling flows and Quality of Service (QoS) parameter mapping**

This specification adds detailed flows of Policy and Charging Control over the Rx and Gx reference points and their relationship with the bearer level signalling flows over the Gn interface. This specification also describes the binding and the mapping of QoS parameters among SDP, UMTS QoS parameters, and QoS authorization parameters.

#### **1.2.2.2.241 TS 29.214**

##### **Policy and charging control over Rx reference point**

This specification provides the stage 3 specification of the Rx reference point that lies between the application function and the policy and charging rule function.

#### **1.2.2.2.242 TS 29.215**

##### **Policy and Charging Control (PCC) over S9 reference point; Stage 3**

This document provides the stage 3 specification of the S9 reference point for this release. The functional requirements of stage 2 specification for the S9 reference point are contained in 3GPP TS 23.203. The S9 reference point lies between the PCRF in the home PLMN (also known as H-PCRF) and the PCRF in the visited PLMN (also known as V-PCRF). Whenever it is possible this document specifies the requirements for the protocols by reference to specifications produced by the IETF within the scope of Diameter. Where this is not possible extensions to Diameter are defined within this document.

#### **1.2.2.2.243 TS 29.219**

##### **Policy and charging control: Spending limit reporting over Sy reference point**

This document provides the protocol specification related to the Sy reference point. The Sy reference point lies between the Policy and Charging Rule Function (PCRF) and the Online Charging System (OCS). It enables transfer of policy counter status information relating to subscriber spending from OCS to PCRF.

#### **1.2.2.2.244 TS 29.228**

##### **IP Multimedia (IM) Subsystem Cx and Dx Interfaces; Signalling flows and message contents**

This 3GPP technical specification (TS) specifies the interactions between the HSS (Home Subscriber Server) and the CSCF (Call Session Control Functions), referred to as the Cx interface, and the interactions between the CSCF and the SLF (Server Locator Function), referred to as the Dx interface.

**1.2.2.2.245 TS 29.229****Cx and Dx interfaces based on the Diameter protocol; Protocol details**

This specification defines a transport protocol for use in the IP multimedia (IM) Core Network (CN) subsystem based on Diameter.

**1.2.2.2.246 TS 29.230****Diameter applications; 3GPP specific codes and identifiers**

This document lists the 3GPP specific Diameter protocol codes, including the AVP codes and Experimental result codes. This document lists also the application identifiers assigned to 3GPP specific Diameter applications by IANA and the Diameter command code range which is assigned to 3GPP by IANA.

**1.2.2.2.247 TS 29.231****Application of SIP-I Protocols to Circuit Switched (CS) core network architecture; Stage 3**

This specification describes the protocols to be used when SIP-I is optionally used as call control protocol in a 3GPP CS core network on Nc interface. The SIP-I protocol operates between (G)MSC servers. The SIP-I architecture consists of a number of protocols. The following types of protocols are described: call control protocol, resource control protocols and user plane protocol for this architecture.

**1.2.2.2.248 TS 29.232****Media Gateway Controller (MGC) – Media Gateway (MGW) interface; Stage 3**

This document describes the protocol to be used on the Media Gateway Controller (MGC) – Media Gateway (MGW) interface. The Media Gateway Controllers covered in this specification are the MSC server and the GMSC server. The basis for this interface profile is the H.248.1 protocol as specified in ITU-T.

**1.2.2.2.249 TS 29.235****Interworking between SIP-I based circuit-switched core network and other networks**

This specification defines the interworking between SIP-I based circuit-switched core network with out-of-band transcoder control related procedures and:

- an external SIP-I based signalling network;
- an ISUP based network such as an ISUP based 3GPP CS Domain or an PSTN;
- an BICC based network such as an BICC based 3GPP CS Domain;
- an Internet Multimedia Subsystem.

**1.2.2.2.250 TS 29.238****Interconnection Border Control Functions (IBCF) – Transition Gateway (TrGW) interface; Ix interface; Stage 3**

This document describes the protocol to be used on the Interconnection Border Control Function (IBCF) – Transition Gateway (TrGW) interface and the CS-IBCF – CS-TrGW interface. The basis for this protocol is the H.248 protocol as specified in ITU-T.

**1.2.2.2.251 TS 29.272****Evolved Packet System (EPS); Mobility Management Entity (MME) and Serving GPRS Support Node (SGSN) related interfaces based on Diameter protocol**

This document describes the Mobility Management Entity (MME) and Serving GPRS Support Node (SGSN) related diameter-based interfaces towards the Home Subscriber Server (HSS), and the MME and the SGSN related diameter-based interface towards the Equipment Identity Register (EIR).

**1.2.2.2.252 TS 29.273****Evolved Packet System (EPS); 3GPP EPS AAA interfaces**

This document defines the stage-3 protocol description for several reference points for the non-3GPP access in EPS.

**1.2.2.2.253 TS 29.274****3GPP Evolved Packet System (EPS); Evolved General Packet Radio Service (GPRS) Tunnelling Protocol for Control plane (GTPv2-C); Stage 3**

This document specifies the stage 3 of the control plane of the GPRS Tunnelling Protocol, Version 2 for Evolved Packet System interfaces (GTPv2-C). In this document, unless otherwise specified the S5 interface refers always to “GTP-based S5” and S8 interface refers always to “GTP-based S8” interface.

**1.2.2.2.254 TS 29.275****Proxy Mobile IPv6 (PMIPv6) based Mobility and Tunnelling protocols; Stage 3**

This document specifies the stage 3 of the PMIPv6 Based Mobility and Tunnelling Protocols used over the PMIP-based S2a, S2b, S5, and S8 reference points defined in 3GPP TS 23.402, and are thus applicable to the Serving GW, PDN Gateway, ePDG, and Trusted Non-3GPP Access. Protocols specifications are compliant with relevant IETF RFCs. In this specification PMIP refers to PMIPv6 as defined in IETF RFC5213.

**1.2.2.2.255 TS 29.276****3GPP Evolved Packet System (EPS); Optimized handover procedures and protocols between E-UTRAN access and cdma2000 HRPD Access; Stage 3**

This document specifies the stage 3 of the Evolved Packet System S101 interface between the MME and the HRPD Access Network. The S101 interface supports procedures for Pre-Registration, Session Maintenance and Active handoffs between E-UTRAN and HRPD networks.

**1.2.2.2.256 TS 29.278****Customized Applications for Mobile network Enhanced Logic (CAMEL) Phase 4; CAMEL Application Part (CAP) specification for IP Multimedia Subsystems (IMS)**

This document specifies the CAMEL Application Part (CAP) supporting the fourth phase of the network feature Customized Applications for Mobile network Enhanced Logic for IP Multimedia CN subsystems. CAP is based on a sub-set of the ETSI Core INAP CS-2 as specified by ETSI EN 301 140-1. Descriptions and definitions provided by ETSI EN 301 140-1 are directly referenced by this standard in case no additions or clarifications are needed for the use in the CAP.

**1.2.2.2.257 TS 29.280****Evolved Packet System (EPS); 3GPP Sv interface (MME to MSC, and SGSN to MSC) for SRVCC**

This document describes the Sv interface between the Mobility Management Entity (MME) or Serving GPRS Support Node (SGSN) and 3GPP MSC server enhanced for SRVCC. Sv interface is used to support Inter-RAT handover from VoIP/IMS over EPS to CS domain over 3GPP UTRAN/GERAN access or from UTRAN (HSPA) to 3GPP UTRAN/GERAN access.

**1.2.2.2.258 TS 29.281****General Packet Radio System (GPRS) Tunnelling Protocol User Plane (GTPv1-U)**

This document defines the user plane of GTP used on:

- the Gn and Gp interfaces of the General Packet Radio Service (GPRS);
- the Iu, Gn and Gp interfaces of the UMTS system;
- the S1-U, X2, S4, S5, S8 and S12 interfaces of the Evolved Packet System (EPS).

**1.2.2.2.259 TS 29.282****Mobile IPv6 vendor specific option format and usage within 3GPP**

This document specifies the format and usage of the Mobile IPv6 Vendor Specific Option within the Third Generation Partnership Project.

**1.2.2.2.260 TS 29.292****Interworking between the IP Multimedia (IM) Core Network (CN) subsystem (IMS) and MSC Server for IMS Centralized Services (ICS)**

IMS Centralized Services (ICS) enable the delivery of IM CN subsystem based multimedia telephony and supplementary services as defined in 3GPP TS 24.173 to users regardless of the attached access network type; e.g. CS domain access or IP-CAN.

This document specifies the principles of interworking between the IM CN subsystem and CS domain in order to enable ICS for UEs using CS domain access. This document addresses the area of registration procedures interworking between the CS domain and IM CN subsystem. This document addresses the areas of control and user plane interworking between the IM CN subsystem and CS domain through an MSC Server enhanced for ICS and CS-MGW respectively. This includes the signalling procedures between the MSC Server and CS-MGW. For the specification of control plane interworking, present document defines the protocol interworking between the 3GPP profile of SIP as described in 3GPP TS 24.229 and NAS signalling as described in 3GPP TS 24.008 required for the support of IM CN subsystem based multimedia telephony and supplementary services.

**1.2.2.2.261 TS 29.303****Domain Name System Procedures; Stage 3**

This document describes Domain Name System (DNS) Procedures for the Evolved Packet System. This document covers the Evolved Packet Core gateway node selection using DNS (e.g. SGW and PGW nodes) excluding all User Equipment (UE) initiated DNS-based discovery and selection procedures.

### 1.2.2.2.262 TS 29.305

#### **InterWorking Function (IWF) between MAP based and Diameter based interfaces**

This document is to specify the InterWorking Functions (IWF):

- between MAP-based Gr, Gf interfaces and Diameter-based S6a, S6d, S13, S13a interfaces;
- between the S6a interface with SMS subscription data on the MME side and the S6a interface without SMS subscription data plus the MAP-based D interface for SMS subscription on the HSS side;
- between the S6a interface with SMS subscription data on the MME side and the S6a interface without SMS subscription data plus the MAP-based D interface for SMS subscription on the HSS side;
- between MAP-based C for SMS interface and Diameter-based S6c interface;
- between MAP-based E for SMS interface and Diameter-based SGd interface.

### 1.2.2.2.263 TS 29.311

#### **Service level interworking for messaging services**

This document specifies the protocol details of service level interworking between Instant Message as specified in OMA-TS-SIMPLE\_IM using the 3GPP IP Multimedia CN subsystem and the Short Message Service over both legacy CS/PS network as specified in the 3GPP TS 23.040 and a generic IP Connectivity Access Network (IP-CAN) as specified in the 3GPP TS 24.341. These include:

- procedures to implement service level interworking between IM and SM;
- procedures to implement service level interworking between CPM and SM;
- enhancement of the IP-SM-GW as an Application Server to support service selection, authorization and mapping between IM and SM protocols;
- interaction between service level interworking and transport layer interworking.

### 1.2.2.2.264 TS 29.328

#### **IP Multimedia (IM) Subsystem Sh interface; Signalling flows and message contents**

This 3GPP technical specification (TS) specifies: The interactions between the HSS (Home Subscriber Server) and the SIP AS (Application Server) and between the HSS and the OSA SCS (Service Capability Server). This interface is referred to as the Sh reference point. The interactions between the SIP AS and the SLF (Subscription Locator Function) and between the OSA SCS and the SLF. This interface is referred to as the Dh reference point.

### 1.2.2.2.265 TS 29.329

#### **Sh interface based on the Diameter protocol; Protocol details**

This document defines a transport protocol for use in the IP multimedia (IM) Core Network (CN) subsystem based on Diameter. This document is applicable to:

- The Sh interface between an AS and the HSS.
- The Sh interface between an SCS and the HSS.

Whenever it is possible this document specifies the requirements for this protocol by reference to specifications produced by the IETF within the scope of Diameter. Where this is not possible, extensions to Diameter are defined within this document.

**1.2.2.2.266 TS 29.333****Multimedia Resource Function Controller (MRFC) – Multimedia Resource Function Processor (MRFP) Mp interface; Stage 3**

This document describes the protocol to be used on the Multimedia Resource Function Controller (MRFC) – Multimedia Resource Function Processor (MRFP) interface (Mp interface). The IMS architecture is described in 3GPP TS 23.228, the functional requirements are described in 3G TS 23.333. This specification defines a profile of the Gateway Control Protocol (H.248.1), for controlling Multimedia Resource Function Processor supporting in-band user interaction, conferencing and transcoding for multimedia-services. This document is valid for a 3<sup>rd</sup> generation PLMN (UMTS) complying with Release 7 and later.

**1.2.2.2.267 TS 29.334****IMS Application Level Gateway (IMS-ALG) – IMS Access Gateway (IMS-AGW); Iq Interface; Stage 3**

This document describes the protocol to be used on the IMS Application Level Gateway (ALG) – IMS Access Gateway (IMS-AGW) interface. The basis for this protocol is the H.248 protocol as specified in ITU-T. The IMS architecture is described in 3GPP TS 23.228.

**1.2.2.2.268 TS 29.335****User Data Convergence (UDC); User data repository access protocol over the Ud interface; Stage 3**

This document describes the stage 3 user data repository access protocol over Ud interface.

**1.2.2.2.269 TS 29.336****Home Subscriber Server (HSS) diameter interfaces for interworking with packet data networks and applications**

This document describes the Diameter-based interfaces between the HSS and other network elements involved in the architecture for interworking with packet data networks and applications, such as Machine-Type Communications (MTC).

In particular, this document specifies the S6m interface between the Home Subscriber Server (HSS) and the MTC Interworking Function (MTC-IWF) and the S6n interface between the HSS and the MTC-AAA. The procedures over those interfaces are defined in 3GPP TS 23.682.

**1.2.2.2.270 TS 29.337****Diameter-based T4 Interface for communications with packet data networks and applications**

This document describes the Diameter based interface between the Machine Type Communications-InterWorking Function (MTC-IWF) and the Short Message Service-Service Centre (SMS-SC) for communications with packet data networks and applications.

This specification defines the Diameter application for the T4 reference point between the MTC-IWF and the SMS-SC. The interactions between the MTC-IWF and the SMS-SC are specified.

The stage 2 description for communications with packet data networks and applications (architecture and functionality) is specified in the 3GPP TS 23.682.

**1.2.2.2.271 TS 29.338****Diameter based protocols to support Short Message Service (SMS) capable Mobile Management Entities (MMEs)**

This document defines the Diameter-based interfaces specific to SMS when they are used in conjunction with the “SMS in MME” architecture specified in 3GPP TS 23.272. It comprises:

- the Diameter application for the S6c interface between the HSS and the SMS-GMSC or the SMS Router and between the SMS-GMSC and the SMS Router;
- the Diameter application for the SGd interface between the MME and the SMS-IWMSC or the SMS-GMSC or the SMS Router and between the SMS-GMSC and the SMS Router.

**1.2.2.2.272 TS 29.343****Proximity-services (ProSe) function to ProSe application server aspects (PC2); Stage 3**

This document provides the stage 3 specification of the PC2 reference point. The functional requirements and the stage 2 procedures of the PC2 reference point are contained in 3GPP TS 23.303. The PC2 reference point lies between the ProSe Function and ProSe Application Server.

**1.2.2.2.273 TS 29.344****Proximity-services (ProSe) function to Home Subscriber Server (HSS) aspects; Stage 3**

This document describes the Diameter-based PC4a interface between the Proximity Services (ProSe) Function and the Home Subscriber Server (HSS) defined for ProSe services.

This specification defines the Diameter application for PC4a reference point between the ProSe Function and the HSS. The interactions between the ProSe Function and the HSS are specified.

The stage 2 description for Proximity Services (ProSe) features in EPS is specified in 3GPP TS 23.303.

**1.2.2.2.274 TS 29.345****Inter-Proximity-services (ProSe) function signalling aspects; Stage 3**

This document describes the Diameter-based interfaces between the Proximity Services (ProSe) Function in the HPLMN and the ProSe Function in a local PLMN (PC6 interface) or between the Proximity Services (ProSe) Function in the HPLMN and the ProSe Function in a visited PLMN (PC7 interface).

This specification defines the Diameter application for PC6/PC7 reference points between the ProSe Functions. The interactions between the ProSe Functions are specified.

The stage 2 description for Proximity Services (ProSe) features in EPS is specified in 3GPP TS 23.303.

**1.2.2.2.275 TS 29.364****IP Multimedia Subsystem (IMS) Application Server (AS) service data descriptions for AS interoperability**

This specification standardizes the structure and the coding of the service data that are transported over the Sh interface between an Application Server supporting Multimedia Telephony supplementary services as defined in 3GPP TS 22.173 and the HSS. Two optional formats are specified. One is based on a binary coding of the service data and supports the subset of MMTEL services corresponding to PSTN/ISDN and CS supplementary services. The other uses an XML format and supports the full set of MMTEL services.

**1.2.2.2.276 TS 29.368****Tsp interface protocol between the MTC Interworking Function (MTC-IWF) and Service Capability Server (SCS)**

This document provides the protocol specification related to the Tsp reference point which is part of the architecture for Machine Type Communication. The Tsp reference point lies between the Service Capability Server (SCS) and the Machine Type Communication Inter Working Function (MTC-IWF).

**1.2.2.2.277 TS 29.468****Group Communication System Enablers for LTE (GCSE\_LTE); MB2 reference point; Stage 3**

This document defines the protocol for the MB2 reference point between the Group Communication Service Application Server (GCS AS) and the Broadcast-Multicast Service Centre (BM-SC).

The MB2 reference point and related stage 2 procedures are defined in 3GPP TS 23.468 as part of the Group Communication System Enablers for LTE. The stage 1 requirements for Group Communication System Enablers for LTE are specified in 3GPP TS 22.468.

**1.2.2.2.278 TS 29.658****SIP Transfer of IP Multimedia Service Tariff Information; Protocol specification**

This document specifies the protocol for the real-time transfer of Tariff Information between a Charge Determination Point (CDP) and a Charge Generation Point (CGP) by means of the Session Initiation Protocol (SIP).

It identifies the protocol procedures and switching functions needed to support the transfer of tariff information related to IP multimedia services.

**1.2.2.2.279 TS 31.101****UICC-terminal interface; Physical and logical characteristics**

This specification specifies the interface between the UICC and the Terminal for 3G and beyond telecom network operation. This includes the requirements for the physical characteristics of the UICC, the electrical interface between the UICC and the Terminal, the initial communication establishment and the transport protocols, the communication commands and the procedures and the application independent files and protocols.

**1.2.2.2.280 TS 31.102****Characteristics of the Universal Subscriber Identity Module (USIM) application**

This specification defines the USIM application for 3G and beyond telecom network operation. This specification specifies command parameters, file structures and content, security functions and the application protocol to be used on the interface between UICC (USIM) and ME.



**1.2.2.2.281 TS 31.103****Characteristics of the IP Multimedia Services Identity Module (ISIM) application**

This specification defines the ISIM application for 3G and beyond telecom network operation. This specification specifies command parameters, file structures and content, security functions and the application protocol to be used on the interface between UICC (ISIM) and ME.

**1.2.2.2.282 TS 31.104****Characteristics of the Hosting Party Subscription Identity Module (HPSIM) application**

This document defines the Hosting Party Subscription Identity Module (HPSIM) application. This application resides on the UICC, an IC card specified in 3GPP TS 31.101.

3GPP TS 31.104 applies to a H(e)NB supporting the HPSIM for H(e)NB Hosting Party authentication and specifies:

- identification of the Hosting Party;
- security mechanism, e.g. authentication based on EAP-AKA method.

**1.2.2.2.283 TS 31.111****Universal Subscriber Identity Module (USIM) Application Toolkit (USAT)**

This specification defines the interface between the UICC and the Mobile Equipment (ME), and mandatory ME procedures, specifically for “USIM Application Toolkit”. USAT is a set of commands and procedures for use during the network operation phase of 3G and beyond, in addition to those defined in TS 31.101.

**1.2.2.2.284 TS 31.115****Secured packet structure for (Universal) Subscriber Identity Module (U)SIM Toolkit applications**

This specification specifies the structure of the Secured Packets in implementations using Short Message Service and Cell Broadcast Service. It is applicable to the exchange of secured packets between an entity in a 3G and beyond or GSM PLMN and an entity in the (U)SIM.

**1.2.2.2.285 TS 31.116****Remote APDU Structure for (Universal) Subscriber Identity Module (U)SIM Toolkit applications**

This specification defines the remote management of files and applets on the SIM/USIM.

**1.2.2.2.286 TS 31.130****(U)SIM Application Programming Interface (API); (U)SIM API for Java Card**

This specification defines the (U)SIM Application Programming Interface extending the “UICC API for Java Card™”. This API allows development of a (U)SAT application running together with a (U)SIM application and using GSM/3G and beyond network features.

**1.2.2.2.287 TS 31.133****IP Multimedia Services Identity Module (ISIM) Application Programming Interface (API); ISIM API for Java Card™**

This specification defines the ISIM Application Programming Interface extending the “UICC API for Java Card™”. This API allows development of an application running together with an ISIM application. This document includes information applicable to network operators, service providers, server, ISIM and database manufacturers.

**1.2.2.2.288 TS 31.220****Characteristics of the Contact Manager for 3GPP UICC applications**

This specification defines the Contact Manager for 3GPP UICC applications based on OMA DS, also specifies the external interface between the Contact Manager Server in the UICC and the Contact Manager External Client in the ME.

**1.2.2.2.289 TS 31.221****Contact Manager Application Programming Interface (API); Contact Manager API for Java Card**

This specification defines the Application Programming Interface for the Contact Manager for 3GPP UICC applications, as specified in TS 31.220. This API allows development of applications running together with a contact manager application.

**1.2.2.2.290 TS 32.101****Telecommunication management; Principles and high-level requirements**

This document establishes and defines the management principles and high-level requirements for the management of PLMNs. In particular, this document identifies the requirements for:

- the upper level of a management system;
- the reference model, showing the elements the management system interacts with;
- the network operator processes needed to run, operate and maintain a network;
- the functional architecture of the management system;
- the principles to be applied to management interfaces.

The requirements identified in this document are directed to the further development of management specifications as well as the development of management products. This document can be seen as guidance for the development of all other technical specifications addressing the management of PLMNs.

**1.2.2.2.291 TS 32.102****Telecommunication management; Architecture**

This document identifies and standardizes the most important and strategic contexts in the physical architecture for the management of PLMNs. It serves as a framework to help define a telecom management physical architecture for a planned PLMN and to adopt standards and provide products that are easy to integrate. The requirements identified in this document are applicable to all further development of 3GPP Telecom Management specifications as well as the development of PLMN Management products. This document can be seen as guidance for the development of all other technical specifications addressing the management of PLMNs, except TS 32.101.

#### 1.2.2.2.292 TS 32.103

##### **Telecommunication management; Integration Reference Point (IRP) overview and usage guide**

This document gives an overview about 3GPP's management interface capabilities and related functionality. It provides high-level information about IRP Framework, available IRPs as well as their relationship with each other. This document is intended to be a guide into the world of 3GPP management specifications, enabling also non-subject matter experts to gain an understanding about 3GPP's management solutions.

It also provides IRP packaging suggestions, intended to guide service providers as well as equipment and solutions providers to identify and choose suitable standardized management interface capabilities.

#### 1.2.2.2.293 TS 32.150

##### **Telecommunication management; Integration Reference Point (IRP) Concept and definitions**

This document provides the overall concept for all Integration Reference Point (IRP) specifications. Relevant IRP overview and high-level definitions are already provided in 3GPP TS 32.101 and TS 32.102. IRP specifications are intended to be applicable to any management interface developed in 3GPP SA5.

#### 1.2.2.2.294 TS 32.401

##### **Telecommunication management; Performance Management (PM); Concept and requirements**

This document describes the requirements for the management of performance measurements and the collection of performance measurement result data across GSM, UMTS and LTE networks. It defines the administration of measurement schedules by the Network Element Manager (EM), the generation of measurement results in the Network Elements (NEs) and the transfer of these results to one or more Operations Systems, i.e. EM(s) and/or Network Manager(s) (NM(s)).

The basic Performance Management concept that this document is built upon is described in clause 4. The requirements of how an EM administers the performance measurements and how the results can be collected are defined in detail in clause 5. Measurements available for collection by NEs are described in the following specifications:

- TS 52.402 for GSM systems;
- TS 32.405, TS 32.406, TS 32.407 and TS 32.408 for UMTS and combined UMTS/GSM systems;
- TS 32.409 for IMS networks;
- TS 32.425 for E-UTRAN.
- TS 32.426 for EPC.
- TS 32.452 for Home Node B (HNB) Subsystem (HNS).
- TS 32.453 for Home enhanced Node B (HeNB) Subsystem (HeNS).

Effort has been made to ensure consistency in the definition of measurements between different NEs and generations. The performance measurement result is described in Performance Measurement File Format Definition (3GPP TS 32.432).

The following is beyond the scope of this document, and therefore this document does not describe:

- the formal definition of the interface that the EM uses to administer performance measurements in the NEs;
- the formal definition of the interface that the EM uses to collect measurement results from the NEs;
- how the data, once accumulated and collected, could or should be processed, stored, or presented to an end user;
- the information which may be obtained through the collection and processing of call or event related records which have been produced by the NEs primarily for the purpose of raising bills and other charges.

The management requirements have been derived from existing telecommunications operations experience. The management definitions were then derived from other standardisation work so as to minimise the re-invention factor. References are given as appropriate.

The objectives of this standardisation are:

- to provide the descriptions for a standard set of measurements;
- to produce a common description of the management technique for measurement administration and result accumulation; and
- to define a method for the bulk transmission of measurement results across a management interface.

The definition of the standard measurements is intended to result in comparability of measurement result data produced in a multi-vendor wireless network, for those measurement types that can be standardised across all vendors' implementations.

As far as possible, existing standardisation in the area of Performance Management has been re-used and enhanced where particular requirements, peculiar to the mobile telephony environment, have been recognised.

This document considers all the above aspects of Performance Management for a GSM, UMTS or LTE network and its NEs defined in the core Technical Specifications. However, only those aspects which are specific to a GSM/UMTS/LTE system and particular to wireless network operation are included in this document.

#### **1.2.2.2.295 TS 32.409**

##### **Telecommunication management; Performance Management (PM); Performance measurements; IP Multimedia Subsystem (IMS)**

This document describes the measurements of IMS.

3GPP TS 32.401 describes Performance Management concepts and requirements.

This document is valid for all measurement types provided by an implementation of an IMS network. These may be measurement types defined within this document, measurements defined within other standards bodies, or vendor specific measurement types.

Only measurement types that are specific to IMS network are defined within this documents. I.e. vendor specific measurement types and measurements related to "external" technologies used in IMS network, such as ATM or IP, are not covered. Instead, these could be applied as described by the other, "external" standards bodies (e.g. ITU-T or IETF) or according to manufacturer's documentation.

The definition of the standard measurements is intended to result in comparability of measurement data produced in a multi-vendor network, for those measurement types that can be standardised across all vendors' implementations.

The structure of this document is as follows:

- Header 1: Network Element (e.g. measurements related to CSCF);
- Header 2: Measurement function (e.g. Registration related measurements);
- Header 3: Measurements.

#### **1.2.2.2.296 TS 32.425**

##### **Telecommunication management; Performance Management (PM); Performance measurements Evolved Universal Terrestrial Radio Access Network (E-UTRAN)**

This document describes the measurements for E-UTRAN.

TS 32.401 describes Performance Management concepts and requirements.

This document is valid for all measurement types provided by an implementation of an E-UTRAN.

Only measurement types that are specific to E-UTRAN are defined within this documents. Vendor specific measurement types used in E-UTRAN are not covered. Instead, these could be applied according to manufacturer's documentation.

Measurements related to "external" technologies (such as ATM or IP) as described by "external" standards bodies (e.g. ITU-T or IETF) shall only be referenced within this specification, wherever there is a need identified for the existence of such a reference.

The definition of the standard measurements is intended to result in comparability of measurement data produced in a multi-vendor network, for those measurement types that can be standardised across all vendors' implementations.

The structure of this document is as follows:

- Header 1: Network Element (e.g. measurements related to eNodeB);
- Header 2: Measurement function (e.g. RRC connection setup related measurements);
- Header 3: Measurements.

#### **1.2.2.2.297 TS 32.426**

##### **Telecommunication management; Performance Management (PM); Performance measurements Evolved Packet Core (EPC) network**

This document describes the measurements for EPC and combined EPC/UMTS/GSM.

TS 32.401 describes Performance Management concepts and requirements.

This document is valid for all measurement types provided by an implementation of an EPC network and combined EPC/UMTS/GSM network. Only measurement types that are specific to EPC or combined EPC/UMTS/GSM networks are defined within this documents.

Vendor specific measurement types used in EPC and combined EPC/UMTS/GSM networks are not covered. Instead, these could be applied according to manufacturer's documentation.

Measurements related to "external" technologies (such as IP) as described by "external" standards bodies (e.g. IETF) shall only be referenced within this specification, wherever there is a need identified for the existence of such a reference.

The definition of the standard measurements is intended to result in comparability of measurement data produced in a multi-vendor network, for those measurement types that can be standardised across all vendors' implementations.

The structure of this document is as follows:

- Header 1: Network Element (e.g. MME related measurements);
- Header 2: Measurement function;
- Header 3: Measurements.

#### **1.2.2.2.298 TS 32.432**

##### **Telecommunication management; Performance measurement: File format definition**

This document describes the general semantics of performance measurement result and collection. It defines the report file format, report file conventions and the file transfer procedure. Clause 4 specifies the file format for the bulk transfer of performance measurement results to the NM, while clause 5 discusses the file transfer procedure utilised on that interface.

This document does not give the definition of any specific file format – such as XML and ASN.1, which will be given in Performance Measurement eXtensible Markup Language (XML) File Format Definition 3GPP TS 32.435 and Performance Measurement Abstract Syntax Notation 1 (ASN.1) File Format Definition 3GPP TS 32.436.

#### **1.2.2.2.299 TS 32.435**

##### **Telecommunication management; Performance measurement; eXtensible Markup Language (XML) file format definition**

This document describes the XML file format of performance measurement results whose semantics is defined in 3GPP TS 32.432.

#### **1.2.2.2.300 TS 32.436**

##### **Telecommunication management; Performance measurement: Abstract Syntax Notation 1 (ASN.1) file format definition**

This document defines the ASN.1 file format definition for performance measurement results collection whose semantics is defined in 3GPP TS 32.432.

#### **1.2.2.2.301 TS 32.453**

##### **Telecommunication management; Performance Management (PM); Performance measurements Home enhanced Node B (HeNB) Subsystem (HeNS)**

This document describes the measurements for Home enhanced Node B Subsystem (HeNS).

HeNS consists of a HeNB and optionally a HeNB GW. And, it is connected by means of the standard S1 interface to the EPC (Evolved Packet Core), more specifically to the MME (Mobility Management Entity) by means of the S1-MME interface and to the Serving Gateway (S-GW) by means of the S1-U interface

TS 32.401 describes Performance Management concepts and requirements.

This document is valid for all measurement types provided by an implementation of HeNS.

Only measurement types that are specific to HeNS are defined within this documents. Vendor specific measurement types used in HeNS are not covered. Instead, these could be applied according to manufacturer's documentation.

Measurements related to "external" technologies (such as ATM or IP) as described by "external" standards bodies (e.g. ITU-T or IETF) shall only be referenced within this specification, wherever there is a need identified for the existence of such a reference.

The definition of the standard measurements is intended to result in comparability of measurement data produced in a multi-vendor network, for those measurement types that can be standardised across all vendors' implementations.

The structure of this document is as follows:

- Header 1: Network Element (e.g. measurements related to HeNB and HeNB GW);
- Header 2: Measurement function (e.g. HeNB registration measurements);
- Header 3: Measurements.

#### **1.2.2.2.302 TS 32.501**

##### **Telecommunication management; Self-configuration of network elements; Concepts and requirements**

This document describes the concepts how self-configuration works and what IRP requirements need to be met to support this functionality. The document also captures if a requirement shall be met via the Itf-N interface or via other protocols. This version of the TS is restricted to self-configuration of eNBs. The requirements in this document are not imposed on HNBs.

#### **1.2.2.2.303 TS 32.508**

##### **Telecommunication management; Procedure flows for multi-vendor plug-and-play eNode B connection to the network**

This document describes the procedure flows between network entities involved in the **multi-vendor plug-and-play** eNB connection to network.

These procedures are based on requirements and use cases specified in 3GPP TS 32.501. The format of the data exchanged in these procedures is defined in 3GPP TS 32.509.

#### **1.2.2.2.304 TS 32.509**

##### **Telecommunication management; Data formats for multi-vendor plug and play eNode B connection to the network**

This document describes the data formats used between network entities involved in the multi-vendor plug and play eNB connection to network.

These data formats are based on requirements and use cases specified in 3GPP TS 32.501. The procedure flows where these data exchanged are defined in 3GPP TS 32.508.

#### **1.2.2.2.305 TS 32.602**

##### **Telecommunication management; Configuration Management (CM); Basic CM Integration Reference Point (IRP); Information Service (IS)**

This document defines a component of an Integration Reference Point (IRP) through which an 'IRP Agent' (typically an Element Manager or Network Element) can communicate basic Configuration Management related information to one or several 'IRP Managers' (typically Network Managers).

The function of this Basic CM IRP Information Service is to define an interface for the retrieval and modification of Configuration Management Information.

This Basic CM IRP IS is aligned with ITU-T M.3700 in that ITU-T M.3700 is a subset of the Basic CM IRP IS in terms of the definitions of operations for the retrieval and modification of Configuration Management Information.

#### **1.2.2.2.306 TS 32.612**

##### **Telecommunication management; Configuration Management (CM); Bulk CM Integration Reference Point (IRP): Information Service (IS)**

This document (Bulk Configuration Management IRP: Information Service) defines a number of Integration Reference Point (IRP) through which an 'IRPAgent' (typically an Element Manager or Network Element) can communicate bulk Configuration Management related information to one or several 'IRPManagers' (typically Network Managers).

#### **1.2.2.2.307 TS 33.102**

##### **Security architecture**

Provides a specification of all security mechanisms and protocols, except algorithms.

#### **1.2.2.2.308 TS 33.105**

##### **Cryptographic algorithm requirements**

Defines requirements for standard cipher and integrity algorithm.

#### **1.2.2.2.309 TS 33.106**

##### **Lawful interception requirements**

Defines all requirements for network based lawful interception.

#### **1.2.2.2.310 TS 33.303**

##### **Proximity-based Services (ProSe); Security aspects**

This document specifies the security aspects of the Proximity Services (ProSe) features in EPS. The ProSe features covered are:

- Configuration of ProSe-enabled UEs;
- Open ProSe Direct Discovery (in network coverage);
- One-to-many communication for ProSe-enabled Public Safety UEs;
- EPC-level ProSe Discovery;
- EPC support for WLAN Direct Communication.

#### **1.2.2.2.311 TS 33.187**

##### **Security aspects of Machine-Type Communications (MTC) and other mobile data applications communications enhancements**

This document specifies the security architecture enhancements (i.e., enhancements to the security features and the security mechanisms) to facilitate Machine-Type and other mobile data applications Communications enhancements (MTCe) as per the use cases and service requirements defined in 3GPP TS 22.368 and the architecture enhancements and procedures defined in 3GPP TS 23.682.

#### **1.2.2.2.312 TS 35.231**

##### **Specification of the TUAk algorithm set: A second example algorithm set for the 3GPP authentication and key generation functions f1, f1\*, f2, f3, f4, f5 and f5\*; Document 1: Algorithm specification**



This document and the other Technical Specifications in the series, TS 35.232 and 35.233 contain an example set of algorithms which could be used as the authentication and key generation functions  $f1$ ,  $f1^*$ ,  $f2$ ,  $f3$ ,  $f4$ ,  $f5$  and  $f5^*$  for 3GPP systems. All seven functions are operator-specifiable rather than being fully standardised and other algorithms could be envisaged.

#### 1.2.2.2.313 TS 35.232

**Specification of the TUAk algorithm set: A second example algorithm set for the 3GPP authentication and key generation functions  $f1$ ,  $f1^*$ ,  $f2$ ,  $f3$ ,  $f4$ ,  $f5$  and  $f5^*$ ; Document 2: Implementers' test data**

This document and the other Technical Specifications in the series, TS 35.231 and TS 35.233, contain an example set of algorithms which could be used as the authentication and key generation functions  $f1$ ,  $f1^*$ ,  $f2$ ,  $f3$ ,  $f4$ ,  $f5$  and  $f5^*$  for 3GPP systems. In particular, this document defines the test data:

- for the Keccak permutation used within Tuak,
- for the authentication algorithms  $f1$  and  $f1^*$ ,
- for the algorithms  $f2$ ,  $f3$ ,  $f4$ ,  $f5$  and  $f5^*$ .

#### 1.2.2.2.314 TS 35.233

**Specification of the TUAk algorithm set: A second example algorithm set for the 3GPP authentication and key generation functions  $f1$ ,  $f1^*$ ,  $f2$ ,  $f3$ ,  $f4$ ,  $f5$  and  $f5^*$ ; Document 3: Design conformance test data**

This document and the other Technical Specifications in the series, TS 35.231 and TS 35.232, contain an example set of algorithms which could be used as the authentication and key generation functions  $f1$ ,  $f1^*$ ,  $f2$ ,  $f3$ ,  $f4$ ,  $f5$  and  $f5^*$  for 3GPP systems.

This document provides sets of input/output test data for 'black box' testing of physical realizations of all algorithms, and in particular:

- Test data for the Keccak permutation used within Tuak.
- Test data for the MILENAGE authentication and key generation algorithms  $f1$ ,  $f1^*$ ,  $f2$ ,  $f3$ ,  $f4$ ,  $f5$  and  $f5^*$ .

## Annex 2

### Specification of the WirelessMAN-Advanced<sup>12</sup> radio interface technology

#### Background

IMT-Advanced is a system with global development activity and the IMT-Advanced terrestrial radio interface specifications identified in this Recommendation have been developed by the ITU in collaboration with the *GCS*<sup>13</sup> *Proponents* and the *Transposing Organizations*. It is noted from Document IMT-ADV/24(Rev.1), that:

- The *GCS Proponent* must be one of the *RIT*<sup>14</sup>/*SRIT*<sup>15</sup> *Proponents* for the relevant technology, **and** must have legal authority to grant to ITU-R the relevant legal usage rights to the relevant specifications provided within a GCS corresponding to a technology in Recommendation ITU-R M.2012
- A *Transposing Organization* must have been authorized by the relevant *GCS Proponent* to produce transposed standards for a particular technology, **and** must have the relevant legal usage rights.

It is further noted that *GCS Proponents* and *Transposing Organizations* must also qualify appropriately under the auspices of Resolution ITU-R 9-4 and the ITU-R “Guidelines for the contribution of material of other organizations to the work of the Study Groups and for inviting other organizations to take part in the study of specific matters (Resolution ITU-R 9-4)”.

The ITU has provided the global and overall framework and requirements, and has developed the Global Core Specification jointly with the *GCS Proponent*. The detailed standardization has been undertaken within the recognized *Transposing Organizations* which operate in concert with the *GCS Proponent*. This Recommendation therefore makes extensive use of references to externally developed specifications.

This approach was considered to be the most appropriate solution to enable completion of this Recommendation within the aggressive schedules set by the ITU and by the needs of administrations, operators and manufacturers.

This Recommendation has therefore been constructed to take full advantage of this method of work and to allow the global standardization time-scales to be maintained. The main body of this Recommendation has been developed by the ITU, with each Annex containing references pointing to the location of the more detailed information.

This Annex 2 contains the detailed information developed by the ITU and “IEEE” (the *GCS Proponent*) and IEEE, ARIB, TTA, ITRI and WiMAX Forum (the *Transposing Organizations*). Such use of referencing enables timely completion and update of the high-level elements of this Recommendation, with change control procedures, transposition, and public enquiry procedures

---

<sup>12</sup> Developed by IEEE as the *WirelessMAN-Advanced* specification incorporated in IEEE Std 802.16 beginning with approval of IEEE Std 802.16m.

<sup>13</sup> Global Core Specifications.

<sup>14</sup> Radio Interface Technology.

<sup>15</sup> Set of Radio Interface Technologies.

being undertaken within the external organization. This information has generally been adopted unchanged, recognizing the need to minimize duplication of work, and the need to facilitate and support an ongoing maintenance and update process.

This general agreement, noting that the detailed information of the radio interface should to a large extent be achieved by reference to the work of external organizations, highlights not only the ITU's significant role as a catalyst in stimulating, coordinating and facilitating the development of advanced telecommunications technologies, but also its forward-looking and flexible approach to the development of this and other telecommunications standards for the 21<sup>st</sup> century.

A more detailed understanding of the process for the development of the first release of this Recommendation may be found in Document IMT-ADV/24(Rev.1) whereas details on the process for the development of Revisions of this Recommendation may be found in Document IMT-ADV/25.

## 2.1 Overview of the radio interface technology

The *WirelessMAN-Advanced* radio interface specification is developed by IEEE. A complete end-to-end system based on *WirelessMAN-Advanced* is called WiMAX 2, as developed by the WiMAX Forum.

### 2.1.1 Overview of physical layer

The following sections highlights selected physical layer (PHY) features.

#### 2.1.1.1 Multiple access scheme

*WirelessMAN-Advanced* uses OFDMA as the multiple-access scheme in downlink (DL) and uplink (UL). It further supports both TDD and FDD duplex schemes including H-FDD operation of the mobile stations (MSs) in the FDD networks. The frame structure attributes and baseband processing are common for both duplex schemes. The OFDMA parameters are summarized in Table 2.1. *WirelessMAN-Advanced* also supports wider channel bandwidths, up to 160 MHz, with carrier aggregation. In Table 2.1, TTG and RTG denote transmit/receive and receive/transmit transition gaps, respectively.

TABLE 2.1  
OFDMA parameters

Nominal channel bandwidth (MHz)		5	7	8.75	10	20	
Sampling factor		28/25	8/7	8/7	28/25	28/25	
Sampling frequency (MHz)		5.6	8	10	11.2	22.4	
FFT size		512	1 024	1 024	1 024	2 048	
Subcarrier spacing (kHz)		10.94	7.81	9.76	10.94	10.94	
Useful symbol time $T_u$ ( $\mu$ s)		91.429	128	102.4	91.429	91.429	
CP $T_g = 1/8 T_u$	Symbol time $T_s$ ( $\mu$ s)		102.857	144	115.2	102.857	102.857
	FDD	Number of OFDM symbols per 5 ms frame	48	34	43	48	48
		Idle time ( $\mu$ s)	62.857	104	46.40	62.857	62.857
	TDD	Number of OFDM symbols per 5 ms frame	47	33	42	47	47
		TTG + RTG ( $\mu$ s)	165.714	248	161.6	165.714	165.714

TABLE 2.1 (end)

CP $T_g = 1/16 T_u$	Symbol time $T_s$ ( $\mu$ s)		97.143	136	108.8	97.143	97.143
	FDD	Number of OFDM symbols per 5 ms frame	51	36	45	51	51
		Idle time ( $\mu$ s)	45.71	104	104	45.71	45.71
	TDD	Number of OFDM symbols per 5 ms frame	50	35	44	50	50
		TTG + RTG ( $\mu$ s)	142.853	240	212.8	142.853	142.853
CP $T_g = 1/4 T_u$	Symbol Time $T_s$ ( $\mu$ s)		114.286	160	128	114.286	114.286
	FDD	Number of OFDM symbols per 5 ms frame	43	31	39	43	43
		Idle time ( $\mu$ s)	85.694	40	8	85.694	85.694
	TDD	Number of OFDM symbols per 5 ms frame	42	30	37	42	42
		TTG + RTG ( $\mu$ s)	199.98	200	264	199.98	199.98

### 2.1.1.2 Frame structure

A superframe is a collection of consecutive equally-sized radio frames whose beginning is marked with a superframe header (SFH), which carries short-term and long-term system configuration information.

In order to decrease the air-link access latency, the radio frames are further divided into a number of subframes where each subframe comprises of an integer number of OFDM symbols. The transmission time interval (TTI) is defined as the transmission latency over the air-link and is equal to a multiple of subframe length (default is one subframe). There are four types of subframes: 1) type-1 subframe, which consists of six OFDM symbols, 2) type-2 subframe, which consists of seven OFDM symbols, 3) type-3 subframe which consists of five OFDM symbols, and 4) type-4 subframe, which consists of nine OFDM symbols and can be used only in UL for channel bandwidth of 8.75 MHz when supporting legacy, i.e. OFDMA TDD WMAN, frames.

The basic frame structure is shown in Fig. 2.1, where superframe length is 20 ms (comprised of four radio frames), radio frame size is 5 ms, and subframe length depends on channel bandwidth, length of cyclic prefix, and subframe type, i.e. type-1/2/3/4. The number of subframes per radio frame is predetermined to maximize the spectral efficiency for each frame configuration depending on channel bandwidth, length of cyclic prefix, subframe type, and duplex mode.

The concept of time zones applies to both TDD and FDD systems. These time zones are time-division multiplexed across time domain in the DL to support both new and legacy MSs. For UL transmissions both time and frequency-division multiplexing approaches can be used to support legacy and new terminals. The non-backward compatible improvements and features are restricted to the new zones. All backward compatible features and functions are used in the legacy zones.

FIGURE 2.1

Basic frame structure

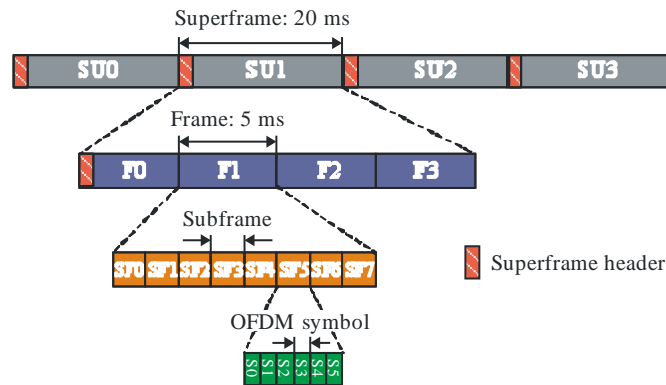

5-275-02-01

2.1.1.3 Physical structure and resource unit

The DL/UL subframes are divided into a number of frequency partitions, where each partition consists of a set of physical resource units (PRUs) over the available number of OFDM symbols in the subframe. Each frequency partition can include localized and/or distributed physical resource units. Frequency partitions can be used for different purposes such as fractional frequency reuse (FFR). The DL/UL resource partitioning and mapping is illustrated in Fig. 2.2. PRU is the basic physical unit for resource allocation that comprises 18 contiguous subcarriers by  $N_{\text{sym}}$  contiguous OFDM symbols where  $N_{\text{sym}}$  is 6, 7, 5 and 9 OFDM symbols for type-1, type-2, type-3 and type-4 subframes, respectively (type-4 is used only for UL). A logical resource unit (LRU) is the basic logical unit for distributed and localized resource allocations. LRU comprises of  $18 \times N_{\text{sym}}$  subcarriers.

FIGURE 2.2

Resource mapping process

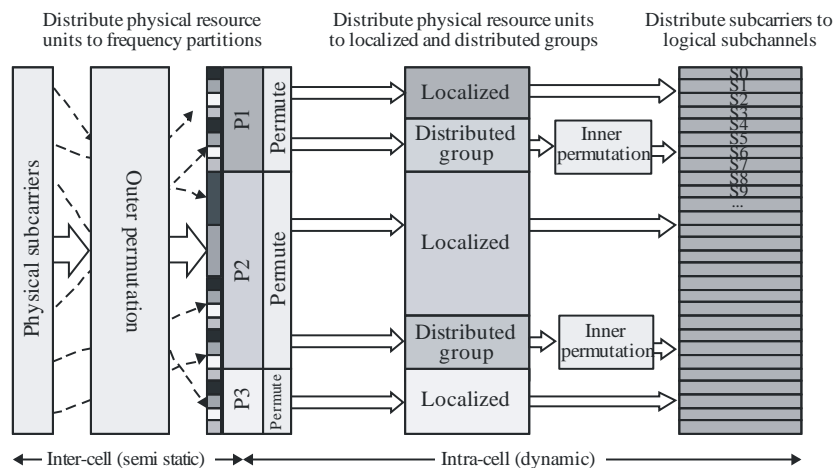

5-275-02-02

### 2.1.1.4 Resource mapping

The resource mapping process is defined as follows as illustrated in Fig. 2.2, where  $P_i$  denotes the  $i$ -th frequency partition.

The PRUs are first subdivided into sub-bands and mini-bands where a sub-band comprises four adjacent PRUs and a mini-band comprises one PRU. The sub-bands are suitable for frequency selective allocations as they provide a contiguous allocation of PRUs in frequency. The mini-bands are suitable for frequency diverse allocations and are permuted in frequency (outer permutation in Fig. 2.2).

After frequency partitioning, the partition between localized or contiguous resource units (CRUs) and distributed resource units (DRUs) is done on a sector specific basis. All sub-bands are categorized into CRU, while mini-bands are categorized into either CRU or DRU. CRUs are used to achieve frequency-selective scheduling gain. A CRU comprises a group of subcarriers which are contiguous across frequency. DRUs are used to achieve frequency diversity gain. A DRU contains a group of subcarriers which are spread across a frequency partition. The sizes of the CRU and DRU are equal to that of PRU.

To form CRUs and DRUs, the subcarriers over the OFDM symbols of a sub-frame are partitioned into guard and used subcarriers. The DC subcarrier is not used. The used subcarriers are divided into PRUs. Each PRU contains pilot and data subcarriers. The number of used pilot and data subcarriers depends on MIMO mode, rank and number of multiplexed MS, as well as the number of OFDM symbols within a sub-frame.

The subcarrier (tone-pair) permutation defined for DRU of a DL frequency partition spreads the subcarriers across all the distributed resource allocations within a frequency partition. After mapping all pilots, the remaining used subcarriers are paired into contiguous subcarrier-pairs (tone-pairs), and then are permuted to define the distributed logical resource units (DLRUs). The DL subcarrier permutation is performed per OFDM symbol within a sub-frame. Each of the DRUs of an UL frequency partition is divided into 3 tiles of 6 adjacent subcarriers over  $N_{\text{sym}}$  symbols. The tiles are collectively permuted across all the distributed resource allocations within a frequency partition to define DLRUs. The contiguous logical resource unit (CLRU) are obtained from direct mapping of CRUs. CLRUs are categorized into sub-band-based LRUs, so called sub-band logical resource unit (SLRU), and mini-band-based LRUs, so called mini-band logical resource unit (NLRU).

### 2.1.1.5 Modulation and coding

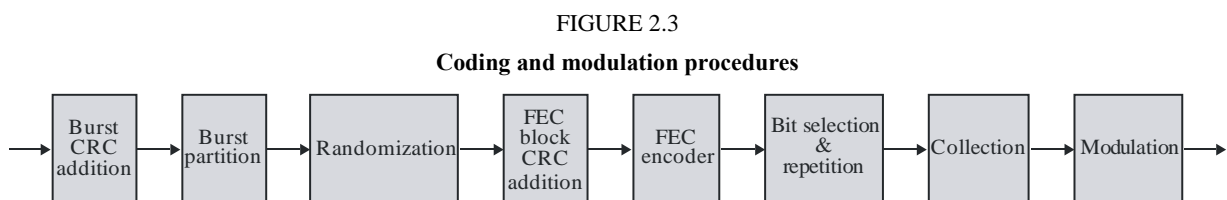

5-275-02-03

Figure 2.3 shows the channel coding and modulation procedures. A cyclic redundancy check (CRC) is appended to a burst (i.e. a physical layer data unit) prior to partitioning. The 16-bit CRC is calculated over the entire bits in the burst. If the burst size including burst CRC exceeds the maximum FEC block size, the burst is partitioned into KFB FEC blocks, each of which is encoded separately. If a burst is partitioned into more than one forward error correction (FEC) blocks, a FEC block CRC is appended to each FEC block before the FEC encoding. The FEC block CRC of a FEC block is calculated based on the entire bits in that FEC block. Each partitioned FEC block including 16-bit FEC block CRC has the same length. The maximum FEC block size is 4800 bits. Concatenation rules

are based on the number of information bits and do not depend on the structure of the resource allocation (number of logical resource units and their size). *WirelessMAN-Advanced* utilizes the convolutional turbo code (CTC) with code rate of 1/3. The CTC scheme is extended to support additional FEC block sizes. Furthermore, the FEC block sizes can be regularly increased with predetermined block size resolutions. The FEC block sizes which are multiple of seven are removed for the tail-biting encoding structure. The encoder block depicted in Fig. 2.3 includes the interleaver.

Bit selection and repetition are used in *WirelessMAN-Advanced* to achieve rate matching. Bit selection adapts the number of coded-bits to the size of the resource allocation which may vary depending on the resource unit size and sub-frame type. The total subcarriers in the allocated resource unit are segmented to each FEC block. The total number of information and parity bits generated by FEC encoder are considered as the maximum size of circular buffer. Repetition is performed when the number of transmitted bits is larger than the number of selected bits. The selection of coded bits is done cyclically over the buffer. The mother-code bits, the total number of information and parity bits generated by FEC encoder, are considered as a maximum size of circular buffer. In case that the size of the circular buffer  $N_{\text{buffer}}$  is smaller than the number of mother-code bits, the first  $N_{\text{buffer}}$  bits of mother-code bits are considered as selected bits.

Modulation constellations of QPSK, 16QAM, and 64QAM are supported. The mapping of bits to the constellation point depends on the constellation-rearrangement (CoRe) version used for HARQ retransmission as described and further depends on the MIMO scheme. The QAM symbols are mapped into the input of the MIMO encoder. The sizes include the addition of CRC (per burst and per FEC block), if applicable. Other sizes require padding to the next burst size. The code rate and modulation depend on the burst size and the resource allocation.

Incremental redundancy HARQ (HARQ-IR) is used in *WirelessMAN-Advanced* by determining the starting position of the bit selection for HARQ retransmissions. Chase combining HARQ (HARQ-CC) is also supported and considered as a special case of HARQ-IR. The 2-bit sub-packet identifier (SPID) is used to identify the starting position. The CoRe scheme can be expressed by a bit-level interleaver.

The resource allocation and transmission formats in each retransmission in DL can be adapted with control signalling. The resource allocation in each retransmission in UL can be fixed or adaptive according to control signalling. In HARQ re-transmissions, the bits or symbols can be transmitted in a different order to exploit the frequency diversity of the channel.

For HARQ retransmission, the mapping of bits or modulated symbols to spatial streams may be applied to exploit spatial diversity with given mapping pattern, depending on the type of HARQ-IR. In this case, the predefined set of mapping patterns should be known to the transmitter and receiver. In DL HARQ, the base station (BS) may transmit coded bits exceeding current available soft buffer capacity.

#### 2.1.1.6 Pilot structure

Transmission of pilot subcarriers in DL is necessary to allow channel estimation, channel quality measurement (e.g. channel quality indicator, CQI), frequency offset estimation, etc. To optimize the system performance in different propagation environments, *WirelessMAN-Advanced* supports both common and dedicated pilot structures. The classification of pilots into common and dedicated is done based on their usage. The common pilots can be used in distributed allocation by all MSs. Dedicated pilots can be used with both localized and distributed allocations. They are associated with user specific pilot index. The dedicated pilots are associated with a specific resource allocation, are intended to be used by the MSs allocated to specific resource allocation, and therefore shall be precoded or beamformed in the same way as the data subcarriers of the resource allocation. The pilot structure is defined for up to eight streams and there is a unified design for common and dedicated

pilots. There is equal pilot density per spatial stream; however, there is not necessarily equal pilot density per OFDM symbols.

FIGURE 2.4

Pilot structures for 1, 2, 4, and 8 streams for Type-1 sub-frame

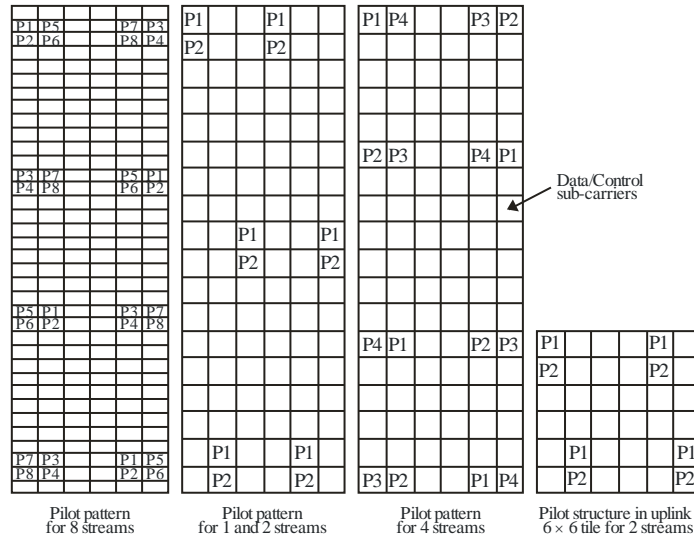

5-275-02-04

For the sub-frame consisting of 5 OFDM symbols, the last OFDM symbol is deleted. For the sub-frame consisting of 7 OFDM symbols, the first OFDM symbol is added as the 7<sup>th</sup> OFDM symbol. To overcome the effects of pilot interference among the neighbouring sectors or BSs, an interlaced pilot structure is utilized by cyclically shifting the base pilot pattern such that the pilots of neighbouring cells do not overlap.

The UL pilots are dedicated to localized and distributed resource units and are precoded using the same precoding as the data subcarriers of the resource allocation. The pilot structure is defined for up to 4 transmit streams for SU-MIMO and up to 8 streams for CSM. When pilots are power-boostered, each data subcarrier should have the same transmission power across all OFDM symbols in a resource block.

The 18 x 6 UL resource blocks use the same pilot patterns as the DL counterpart. The pilot pattern for 6 x 6 tile structure is used for DLRU only in case the number of streams is one or two and it is also shown in Fig. 2.4.

**2.1.1.7 Control channels**

DL control channels carry essential information for system operation. Depending on the type of control signalling, information is transmitted over different time intervals (i.e. from superframe to sub-frame intervals). The system configuration parameters are transmitted at the superframe intervals, whereas control signalling related to user data allocations is transmitted at the frame/sub-frame intervals.

**2.1.1.7.1 Downlink control channels**

**Superframe Header (SFH)**

The superframe header (SFH) carries essential system parameters and configuration information. The content of SFH is divided into two segments; i.e. primary and secondary SFHs. The primary SFH is transmitted every superframe, whereas the secondary SFH is transmitted over one or more superframes. The primary and secondary SFHs are located in the first sub-frame within a superframe



and are time-division-multiplexed with the advanced preamble. The SFH occupies no more than 5 MHz bandwidth. The primary SFH is transmitted using predetermined modulation and coding scheme. The secondary SFH is transmitted using predetermined modulation scheme while its repetition coding factor is signalled in the primary SFH. The primary and secondary SFHs are transmitted using two spatial streams and space-frequency block coding to improve coverage and reliability. The MS is not required to know the antenna configuration prior to decoding the primary SFH. The information transmitted in the secondary SFH is divided into different sub-packets. The secondary SFH sub-packet 1 (SP1) includes information needed for network re-entry. The secondary SFH sub-packet 2 (SP2) contains information for initial network entry. The secondary SFH sub-packet 3 (SP3) contains remaining system information for maintaining communication with the BS.

### Advanced MAP (A-MAP)

The advanced MAP (A-MAP) consists of both user-specific and non-user-specific control information. Non-user-specific control information includes information that is not dedicated to a specific user or a specific group of users. It contains information required to decode user-specific control signalling. User specific control information consists of information intended for one or more users. It includes scheduling assignment, power control information, and HARQ feedback. Resources can be allocated persistently to the MSs. Group control information is used to allocate resources and/or configure resources to one or multiple MSs within a user group. Within a subframe, control and data channels are frequency-division-multiplexed. Both control and data channels are transmitted on logical resource units that span over all OFDM symbols within a subframe.

Each DL subframe contains a control region including both non-user-specific and user-specific control information. All A-MAPs share a time-frequency region known as A-MAP region. The control regions are located in every subframe. The corresponding UL allocations occurs L subframes later, where L is determined by A-MAP relevance. The coding rate is predetermined for non-user-specific information while it is indicated by SFH for user-specific control information.

An A-MAP allocation Information Element (IE) is defined as the basic element of unicast service control. A unicast control IE may be addressed to one user using a unicast identifier or to multiple users using a multicast/broadcast identifier. The identifier is masked with CRC in the A-MAP allocation IE. It may contain information related to resource allocation, HARQ, MIMO transmission mode, etc. Each A-MAP IE is coded separately.

Non-user-specific control information is encoded separately from the user-specific control information. In the DL subframes, frequency partition for reuse-1 and/or frequency partition for power-boosted reuse-3 may contain an A-MAP region. The A-MAP region occupies the first few DLRUs in a frequency partition. The structure of an A-MAP region is illustrated in Fig. 2.5. The resource occupied by each A-MAP physical channel may vary depending on the system configuration and scheduler operation. There are different types of A-MAPs as follows:

- **Assignment A-MAP** contains resource assignment information which is categorized into multiple types of resource assignment IEs (assignment A-MAP IE).
- **HARQ Feedback A-MAP** contains HARQ ACK/NACK information for UL data transmission.
- **Power Control A-MAP** includes fast power control command to MSs.

There are different assignment A-MAP IE types that distinguish between DL/UL, persistent/non-persistent, single user/group resource allocation, basic/extended IE scenarios.

FIGURE 2.5

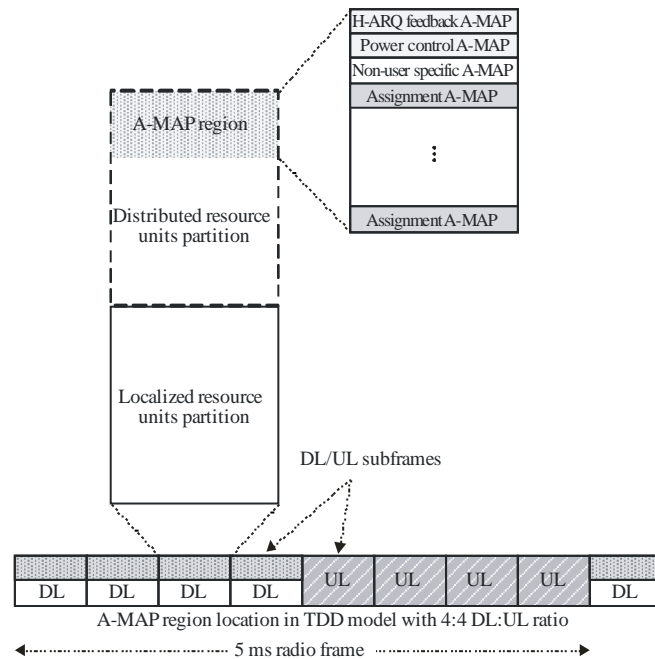
**A-MAP location and structure (example)**

5-275-02-05

**2.1.1.7.2 Uplink control channels****Fast Feedback Channel (FBCH)**

The UL fast feedback channel (FBCH) carries CQI and MIMO feedback.

CQI feedback provides information about channel conditions as seen by the MS. This information is used by the BS for link adaptation, resource allocation, power control, etc. The channel quality measurement includes both narrowband and wideband measurements. The CQI feedback overhead can be reduced through differential feedback or other compression techniques. Examples of CQI include effective carrier to interference plus noise ratio (CINR), band selection, etc.

MIMO feedback provides wideband and/or narrowband spatial characteristics of the channel that are required for MIMO operation. The MIMO mode, preferred matrix index (PMI), rank adaptation information, channel covariance matrix elements, and best sub-band index are examples of MIMO feedback information.

There are two types of UL FBCHs: a) primary fast feedback channel (P-FBCH) and b) secondary fast feedback channel (S-FBCH). S-FBCH can be used to support CQI reporting at higher code rate and thus more CQI information bits. FBCH is frequency-division-multiplexed with other UL control and data channels.

FBCH starts at a predetermined location, with the size defined in a DL broadcast control message. Fast feedback allocations to an MS can be periodic and the allocations are configurable. The specific type of feedback information carried on each fast feedback opportunity can be different. The number of bits carried in the fast feedback channel can be adaptive. For efficient transmission of feedback channels a mini-tile is defined comprising 2 subcarriers by 6 OFDM symbols. One LRU consists of 9 mini-tiles and can be shared by multiple FBCHs.

**HARQ feedback channel**

HARQ feedback (ACK/NACK) is used to acknowledge DL data transmissions. The UL HARQ feedback channel starts at a predetermined offset with respect to the corresponding DL transmission.

The HARQ feedback channel is frequency-division-multiplexed with other control and data channels. Orthogonal codes are used to multiplex multiple HARQ feedback channels. The HARQ feedback channel comprises three distributed mini-tiles.

### **Sounding channel**

The sounding channel is used by an MS to transmit sounding reference signals to enable the BS to measure UL channel conditions. The sounding channel may occupy either specific UL sub-bands or the entire bandwidth over an OFDM symbol. The BS can configure an MS to transmit the UL sounding signal over predefined subcarriers within specific sub-bands or the entire bandwidth. The sounding channel is orthogonally multiplexed (in time or frequency) with other control and data channels. Furthermore, the BS can configure multiple user terminals to transmit sounding signals on the corresponding sounding channels using code-, frequency-, or time-division multiplexing. Power control for the sounding channel can be utilized to adjust the sounding quality. The transmit power from each mobile terminal may be separately controlled according to certain CINR target values.

### **Ranging channel**

The ranging channel is used for UL synchronization. The ranging channel can be further classified into ranging for non-synchronized and synchronized MSs. The ranging channel for non-synchronized MS(NS-RCH) is used for initial network entry and for handover to a target BS. The ranging channel for synchronized MS(S-RCH) is used for periodic ranging. In a femtocell, MSs shall perform initial ranging, handover ranging, and periodic ranging by using the S-RCH.

### **Bandwidth request (BR) channel**

Bandwidth request (BR) channels are used to request UL grant. BRs are transmitted through BR preamble with or without messages. BR messages can include information about the status of queued traffic at the MS such as buffer size and quality of service parameters. Contention or non-contention based random access is used to transmit BR information on this control channel.

The BR channel starts at a configurable location with the configuration defined in a DL broadcast control message. The BR channel is frequency-division-multiplexed with other UL control and data channels. A BR tile is defined as six contiguous subcarriers by six OFDMA symbols. Each BR channel consists of 3 distributed BR tiles. Multiple BR preamble can be transmitted on the same BR channel using code-division multiplexing.

#### **2.1.1.8 Power control**

Power control mechanism is supported for DL and UL. Using DL power control, user-specific information with dedicated pilot is received by the terminal with the controlled power level. The DL advanced MAPs can be power-controlled based on the terminal UL channel quality feedback.

The UL power control is supported to compensate the path loss, shadowing, fast fading and implementation loss as well as to mitigate inter-cell and intra-cell interference. The BS can transmit necessary information through control channel or message to terminals to support UL power control. The parameters of power control algorithm are optimized on system-wide basis by the BS and broadcasted periodically.

In high-mobility scenarios, power control scheme may not be able to compensate the fast fading channel effect because of the variations of the channel impulse response. As a result, the power control is used to compensate the distance-dependent path loss, shadowing and implementation loss only.

The channel variations and implementation loss are compensated via open-loop power control without frequently interacting with the BS. The terminal can determine the transmit power based on the transmission parameters sent by the serving BS, UL channel transmission quality, DL channel state information, and interference knowledge obtained from DL. Open-loop power control provides a coarse initial power setting of the terminal when an initial connection is established.

The dynamic channel variations are compensated via closed-loop power control with power control commands from the serving BS. The BS measures UL channel state and interference information using UL data and/or control channel transmissions and sends power control commands to the terminal. The terminal adjusts its transmission power based on the power control commands from the BS.

**2.1.1.9 Downlink synchronization**

*WirelessMAN-Advanced* utilizes a new hierarchical structure for the DL synchronization where two types of preambles, a) primary advanced preamble (PA-Preamble) and b) secondary advanced preamble (SA-Preamble), are transmitted (Fig. 2.6). One PA-Preamble symbol and two SA-Preamble symbols exist within the superframe. The location of the A-Preamble symbol is specified as the first symbol of frame except for the last frame. PA-Preamble is located at the first symbol of second frame in a superframe while SA-Preamble is located at the first symbol of the first and the third frames. The PA-Preamble carries information about system bandwidth and carrier configuration. The PA-Preamble has a fixed bandwidth of 5 MHz. A frequency reuse of one is applied to the PA-Preamble in frequency domain. SA-Preamble is repeated once every two frames and spans the entire system bandwidth and carries the cell ID. A frequency reuse of three is used for this set of sequences to mitigate inter-cell interference. SA-Preamble carries 768 distinct cell IDs.

The set of SA-Preamble sequences is partitioned and each partition is dedicated to specific BS type such as macro BS, femto BS, etc. The partition information is broadcast in the secondary SFH and AAI-SCD message.

FIGURE 2.6  
Structure of advanced preambles

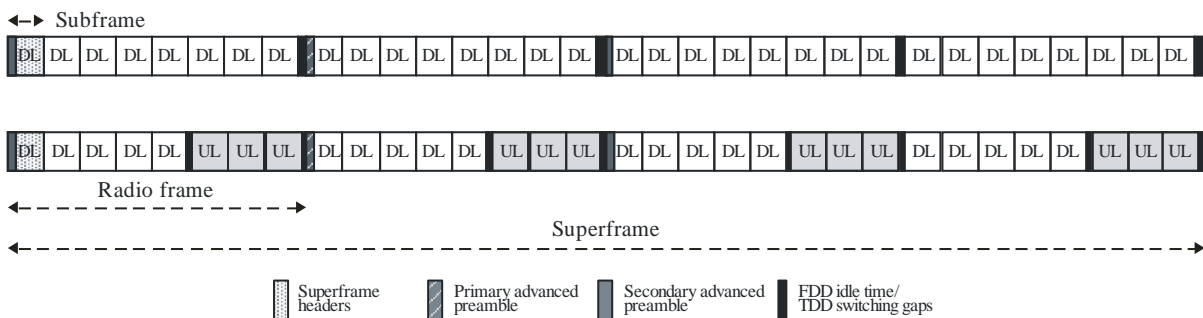

**2.1.1.10 Multi-antenna techniques**

**2.1.1.10.1 MIMO structure**

*WirelessMAN-Advanced* supports several advanced multi-antenna techniques including single and multi-user MIMO (spatial multiplexing and beamforming) as well as a number of transmit diversity schemes. In single-user MIMO (SU-MIMO) scheme only one user can be scheduled over one (time, frequency, space) resource unit. In multi-user MIMO (MU-MIMO), on the other hand, multiple users can be scheduled in one resource unit. Vertical encoding utilizes one encoder block (or layer), whereas multi-layer encoding uses multiple encoders (or multiple layers). A layer is defined as a coding and modulation input path to the MIMO encoder. A stream is defined as the output of the MIMO encoder that is further processed through the beamforming or the precoder block. For spatial multiplexing, the rank is defined as the number of streams to be used for the user.

FIGURE 2.7

**MIMO structure**

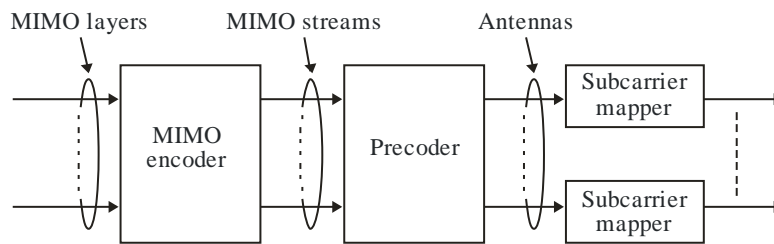

5-275-02-07

The MIMO transmitter structure is shown in Fig. 2.7. The encoder block contains the channel encoder, interleaving, rate-matching, and modulating blocks per layer. The resource mapping block maps the complex-valued modulation symbols to the corresponding time-frequency resources. The MIMO encoder block maps the layers onto the streams, which are further processed through the precoder block.

The precoder block maps the streams to antennas by generating the antenna-specific data symbols according to the selected MIMO mode. The OFDM symbol construction block maps antenna-specific data to the OFDM symbols. Table 2.2 contains information on various MIMO modes supported by *WirelessMAN-Advanced*.

TABLE 2.2

**DL MIMO modes**

Mode index	Description	MIMO encoding format	MIMO precoding
Mode 0	Open-Loop SU-MIMO (TX Diversity)	Space-Frequency Block Coding (SFBC)	Non-Adaptive
Mode 1	Open-Loop SU-MIMO (Spatial Multiplexing)	Vertical Encoding	Non-Adaptive
Mode 2	Closed-Loop SU-MIMO (Spatial Multiplexing)	Vertical Encoding	Adaptive
Mode 3	Open-Loop MU-MIMO (Spatial Multiplexing)	Multi-layer Encoding	Non-Adaptive
Mode 4	Closed-Loop MU-MIMO (Spatial Multiplexing)	Multi-layer Encoding	Adaptive

TABLE 2.2 (*end*)

Mode index	Description	MIMO encoding format	MIMO precoding
Mode 5	Open-Loop SU-MIMO (TX Diversity)	Conjugate Data Repetition (CDR)	Non-Adaptive

The minimum antenna configuration in the DL and UL is  $2 \times 2$  and  $1 \times 2$ , respectively. For open-loop spatial multiplexing and closed-loop SU-MIMO, the number of streams is constrained to the minimum of number of transmit or receive antennas. The MU-MIMO can support up to 2 streams with 2 transmit antennas and up to 4 streams for 4 transmit antennas and up to 8 streams for 8 transmit antennas. Table 2.3 summarized the DL MIMO parameters for various MIMO modes.

TABLE 2.3

## DL MIMO parameters

	Number of transmit antennas	STC rate per layer	Number of streams	Number of subcarriers	Number of layers
MIMO Mode 0	2	1	2	2	1
	4	1	2	2	1
	8	1	2	2	1
MIMO Mode 1 and MIMO Mode 2	2	1	1	1	1
	2	2	2	1	1
	4	1	1	1	1
	4	2	2	1	1
	4	3	3	1	1
	4	4	4	1	1
	8	1	1	1	1
	8	2	2	1	1
	8	3	3	1	1
	8	4	4	1	1
	8	5	5	1	1
	8	6	6	1	1
	8	7	7	1	1
8	8	8	1	1	

TABLE 2.3 (end)

	Number of transmit antennas	STC rate per layer	Number of streams	Number of subcarriers	Number of layers
MIMO Mode 3 and MIMO Mode 4	2	1	2	1	2
	4	1	2	1	2
	4	1	3	1	3
	4	1	4	1	4
	8	1	2	1	2
	8	1	3	1	3
	8	1	4	1	4
MIMO Mode 4	4	2 and 1 <sup>a</sup>	3	1	2
	4	2 and 1 <sup>b</sup>	4	1	3
	4	2	4	1	2
	8	2 and 1 <sup>a</sup>	3	1	2
	8	2 and 1 <sup>b</sup>	4	1	3
	8	2	4	1	2
	8	1	8	1	8
	8	2 and 1 <sup>c</sup>	8	1	7
	8	2 and 1 <sup>d</sup>	8	1	6
	8	2 and 1 <sup>e</sup>	8	1	5
	8	2	8	1	4
MIMO Mode 5	2	1/2	1	2	1
	4	1/2	1	2	1
	7	1/2	1	2	1

<sup>a</sup> 2 streams to one MS and 1 stream to another MS, with 1 layer each.

<sup>b</sup> 2 streams to one MS and 1 stream each to the other two MSs, with 1 layer each.

<sup>c</sup> 2 streams to one MS and 1 stream each to the other six MSs, with 1 layer each.

<sup>d</sup> 2 streams each to two MS and 1 stream each to the other four MSs, with 1 layer each.

<sup>e</sup> 2 streams each to three MS and 1 stream each to the other two MSs, with 1 layer each.

The stream to antenna mapping depends on the MIMO scheme. In DL, the CQI and rank feedback are transmitted to assist the BS in rank adaptation, mode switching, and rate adaptation. For spatial multiplexing, the rank is defined as the number of streams to be used for each user. In FDD and TDD systems, unitary codebook based precoding is used for closed-loop SU-MIMO. In DL, an MS may feedback some information to the BS in closed-loop SU-MIMO such as rank, sub-band selection, CQI, precoding matrix index (PMI), and long-term channel state information.

In DL, the MU-MIMO transmission with up to two streams per user is supported. Beamforming is enabled with this precoding mechanism. *WirelessMAN-Advanced* has the capability to adapt between SU-MIMO and MU-MIMO in a predefined and flexible manner. Multi-BS MIMO techniques are also supported for improving sector and cell-edge throughput using multi-BS collaborative precoding, network coordinated beamforming, or inter-cell interference cancellation.

For UL MIMO, the BS will schedule users to resource blocks and determines the modulation and coding scheme (MCS) level and MIMO parameters (mode, rank, etc.). The supported antenna configurations include 1, 2, or 4 transmit antennas and more than two receive antennas. The UL MIMO modes and parameters are shown in Table 2.4 and Table 2.5, respectively.

TABLE 2.4  
UL MIMO modes

Mode Index	Description	MIMO Encoding Format	MIMO Precoding
Mode 0	Open-Loop SU-MIMO (TX Diversity)	SFBC	Non-Adaptive
Mode 1	Open-Loop SU-MIMO (Spatial Multiplexing)	Vertical Encoding	Non-Adaptive
Mode 2	Closed-Loop SU-MIMO (Spatial Multiplexing)	Vertical Encoding	Adaptive
Mode 3	Open-Loop Collaborative Spatial Multiplexing (MU-MIMO)	Vertical Encoding	Non-Adaptive
Mode 4	Closed-Loop Collaborative Spatial Multiplexing (MU-MIMO)	Vertical Encoding	Adaptive

TABLE 2.5  
UL MIMO parameters

	Number of transmit antennas	STC rate per layer	Number of streams	Number of subcarriers	Number of layers
MIMO Mode 0	2	1	2	2	1
	4	1	2	2	1
MIMO Mode 1	1	1	1	1	1
MIMO Mode 1 and MIMO Mode 2	2	1	1	1	1
	2	2	2	1	1
	4	1	1	1	1
	4	2	2	1	1
	4	3	3	1	1
	4	4	4	1	1
MIMO Mode 3 and MIMO Mode 4	1	1	1	1	1
	2	1	1	1	1
	2	2	2	1	1
	4	1	1	1	1
	4	2	2	1	1
	4	3	3	1	1
	4	4	4	1	1

The supported UL transmit diversity modes include 2 and 4 transmit antenna schemes with rate 1 such as space frequency block coding (SFBC) and 2 stream precoder. In FDD and TDD systems, unitary codebook-based precoding is supported. In this mode, the MS transmits a sounding reference



signal in the UL to assist the UL scheduling and precoder selection in the BS. The BS signals the resource allocation, MCS, rank, preferred precoder index, and packet size to the MS. UL MU-MIMO enables multiple MSs to be spatially multiplexed on the same radio resources. Both open-loop and closed-loop MU-MIMO are supported. The MSs with single transmit antenna can operate in open-loop SU- or MU-MIMO mode.

## 2.1.2 Overview of MAC layer

The following sections describe selected MAC features.

### 2.1.2.1 MAC addressing

*WirelessMAN-Advanced* defines global and logical addresses for an MS that identify the user and its connections during a session. The MS is identified by the globally unique 48-bit IEEE extended unique identifier assigned by the IEEE Registration Authority. The MS is further assigned the following logical identifiers: 1) A station identifier during network entry (or network re-entry), that uniquely identifies the MS within the cell, and 2) a flow identifier (FID) that uniquely identifies the control connections and transport connections with the MS. A temporary station identifier is used to protect the mapping between the actual station identifier during network entry. A deregistration identifier is defined to uniquely identify the MS within the set of paging group identifiers, paging cycle, and paging offset.

### 2.1.2.2 Network entry

Network entry is the procedure through which an MS detects a cellular network and establishes a connection with that network. The network entry has the following steps (see Fig. 2.8):

- synchronization with the BS by acquiring the preambles;
- acquiring necessary system information such as BS and network service provider identifiers for initial network entry and cell selection;
- initial ranging;
- basic capability negotiation;
- authentication/authorization and key exchange;
- registration and service flow setup.

FIGURE 2.8

## Network entry procedures

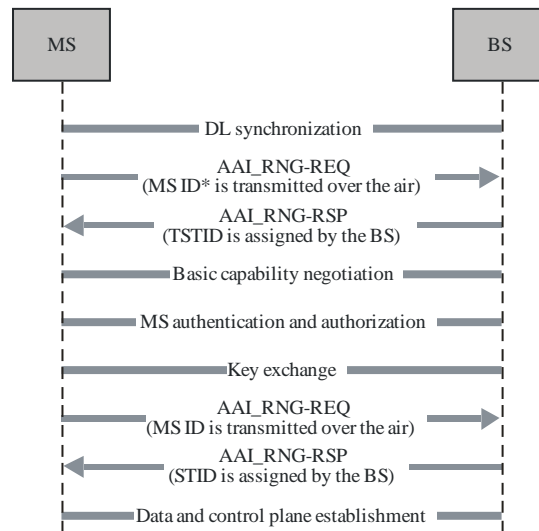

5-275-02-08

### 2.1.2.3 Connection management and quality of service

A connection is defined as a mapping between the MAC layers of a BS and one (or several) MS. If there is a one-to-one mapping between one BS and one MS, the connection is called a unicast connection; otherwise, it is called a multicast or broadcast connection. Two types of connections are specified: control connections and transport connections. Control connections are used to carry MAC control messages. Transport connections are used to carry user data including upper layer signalling messages. A MAC control message is never transferred over transport connection, and user data is never transferred over the control connections. One pair of bi-directional (DL/UL) unicast control connections are automatically established when an MS performs initial network entry.

All the user data communications are in the context of transport connections. A transport connection is unidirectional and established with a unique FID. Each transport connection is associated with an active service flow to provide various levels of QoS required by the service flow. An MS may have multiple transport connections which have different set of QoS parameters, and each transport connection may have one or more sets of QoS parameters.

The transport connection is established when the associated active service flow is admitted or activated, and released when the associated service flow becomes inactive. Transport connections can be preprovisioned or dynamically created. Pre-provisioned connections are those established by system for an MS during the MS network entry. On the other hand, the BS or the MS can create new connections dynamically if required.

### 2.1.2.4 MAC header

*WirelessMAN-Advanced* specifies a number of efficient MAC headers for various applications comprising of fewer fields with shorter size compared to the generic MAC header of OFDMA TDD WMAN. The advanced generic MAC header in Fig. 2.9 consists of Extended Header Indicator, FID, and Payload Length fields. Other MAC header types include two-byte short-packet MAC header, which is defined to support small-payload applications such as VoIP and is characterized by small data packets and non-ARQ connection, Fragmentation extended header, Packing extended header for transport connections, MAC Control extended header for control connections, and Multiplexing extended header that is used when data from multiple connections associated with the same security association is present in the payload of the MAC protocol data unit (PDU).

FIGURE 2.9

Advanced generic MAC headers

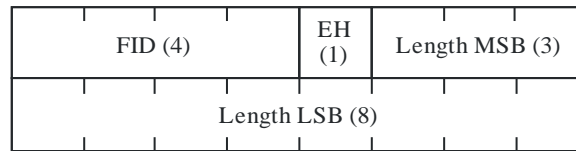

5-275-02-09

**2.1.2.5 ARQ and HARQ functions**

An ARQ block is generated from one or multiple MAC service data units (SDUs) or MAC SDU fragment(s). ARQ blocks can be variable in size and are sequentially numbered.

*WirelessMAN-Advanced* uses adaptive asynchronous and non-adaptive synchronous HARQ schemes in the DL and UL, respectively. The HARQ operation is relying on an N-process (multi-channel) stop-and-wait protocol. In adaptive asynchronous HARQ, the resource allocation and transmission format for the HARQ retransmissions may be different from the initial transmission. In case of retransmission, control signalling is required to indicate the resource allocation and transmission format along with other HARQ necessary parameters. A non-adaptive synchronous HARQ scheme is used in the UL where the parameters and the resource allocation for the retransmission are known *a priori*.

**2.1.2.6 Mobility management and handover**

*WirelessMAN-Advanced* supports both network-controlled and MS-assisted handover (HO). As illustrated in Fig. 2.10, the handover procedures may be initiated by either MS or BS; the final handover decision and target BS selection may be made either by the serving BS or the MS. The MS executes the handover or cancels the procedure through HO cancellation message. The network re-entry procedures with the target BS, as shown in Fig. 2.10, may be optimized by target BS possession of MS information obtained from serving BS via core network. The MS may also maintain communication with serving BS while performing network re-entry at target BS as directed by serving BS.

FIGURE 2.10

Handover procedures

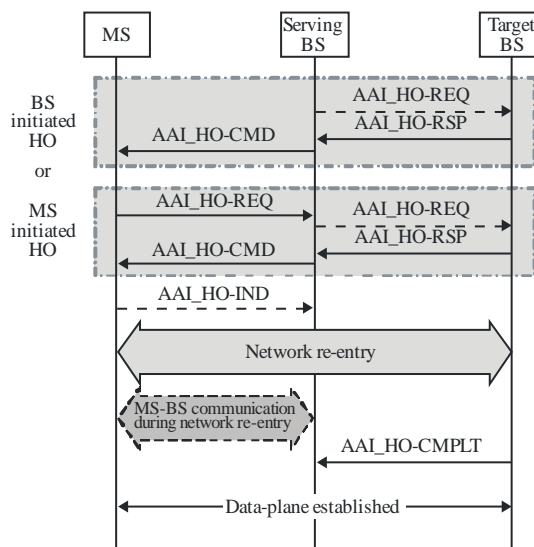

5-275-02-10

### 2.1.2.7 Power management

*WirelessMAN-Advanced* provides power management functions including sleep mode and idle mode to mitigate power consumption of the MS. Sleep mode is a state in which an MS performs prenegotiated periods of absence from the serving BS. The sleep mode may be enacted when an MS is in the connected state. Using the sleep mode, the MS is provided with a series of alternative listening and sleep windows. The listening window is the time interval in which MS is available for transmit/receive of control signalling and data. The *WirelessMAN-Advanced* has the capability of dynamically adjusting the duration of sleep and listening windows within a sleep cycle based on changing traffic patterns and HARQ operations. When MS is in active mode, sleep parameters are negotiated between MS and BS. The base station instructs the MS to enter sleep mode. MAC management messages can be used for sleep mode request/response. The period of the sleep cycle is measured in units of frames or superframes and is the sum of a sleep and listening windows. During the MS listening window, BS may transmit the traffic indication message intended for one or multiple MSs. The listening window can be extended through explicit or implicit signalling. The maximum length of the extension is to the end of the current sleep cycle.

Idle mode allows the MS to become periodically available for DL broadcast traffic messaging such as paging message without registration with the network. The network assigns MSs in the idle mode to a paging group during idle mode entry or location update. If an MS is assigned to multiple paging groups, it may also be assigned multiple paging offsets within a paging cycle where each paging offset corresponds to a separate paging group. The assignment of multiple paging offsets to an MS allows monitoring of the paging messages at different paging offset when the MS is located in one of its paging groups. The distance between two adjacent paging offsets should be long enough so that the MS paged in the first paging offset can inform the network before the next paging offset in the same paging cycle occurs, thereby avoiding unnecessary paging in the next paging offset. The MS monitors the paging message during listening interval. The paging message contains identification of the MSs to be notified of pending traffic or location update. The start of the paging listening interval is calculated based on paging cycle and paging offset are defined in terms of number of superframes.

The serving BS transmits the list of paging group identifiers (PGID) at the predetermined location at the beginning of the paging available interval. During paging available interval, the MS monitors the SFH and if there is an indication of any change in system configuration information, the MS will acquire the latest system information at the next instance of SFH transmission (i.e. next SFH). To provide location privacy, the paging controller assigns Deregistration identifiers to uniquely identify the MSs in the idle mode in a particular paging group.

An MS in idle mode performs location update, if either of these conditions are met, paging group location update, timer based location update, or power down location update. The MS performs the location update when the MS detects a change in paging group by monitoring the PGIDs, which are transmitted by the BS. The MS periodically performs location update procedure prior to the expiration of idle mode timer. At every location update including paging group update, the idle mode timer is reset.

### 2.1.2.8 Security

Security functions provide subscribers with privacy, authentication, and confidentiality across *WirelessMAN-Advanced* network. The PKM protocol provides mutual and unilateral authentication and establishes confidentiality between the MS and the BS by supporting transparent exchange of authentication and authorization (EAP) messages.

The MS and the BS may support encryption methods and algorithms for secure transmission of MAC PDUs. *WirelessMAN-Advanced* supports selectively confidentiality or integrity protection over MAC control messages. Figure 2.11 shows the functional blocks of security architecture.

FIGURE 2.11

## Functional blocks of security architecture

		EAP (out of scope of IEEE 802.16 m specification)
Authorization/Security association control		EAP encapsulation/ De-encapsulation
Location privacy	Enhanced key management	PKM control management
Standalone signaling header authentication	Management message authentication	User data and management message encryption

5-275-02-11

The security architecture is divided into security management and encryption and integrity logical entities. The security management functions include overall security management and control, EAP encapsulation/de-encapsulation, privacy key management (PKM) control, security association management, and identity/location privacy. To accomplish identity/location privacy, the MSID (i.e. MS MAC address) is not disclosed over the air even during network entry. The BS assigns a station identifier (STID) to the MS which is securely transmitted to the MS so that the MS's identity and location can be hidden. The encryption and integrity protection entity functions include encryption of user data and authentication, control message authentication, message confidentiality protection.

## 2.2 Detailed specification of the radio interface technology<sup>16</sup>

The material in § 2.2 reflects the structure of the IEEE specifications from the first release of Recommendation ITU-R M.2012 (01-2012) prior to the IEEE revising the structure of the specifications related to *WirelessMAN-Advanced* on 8 June 2013.

Detailed specifications described in this Annex are developed around a “Global Core Specification” (GCS)<sup>17</sup>, which is related to externally developed materials incorporated by specific references for a specific technology. The process and use of the GCS, references, and related notifications and certifications are found as Document IMT-ADV/24(Rev.1)<sup>18</sup>.

<sup>16</sup> On 8 June 2012, the IEEE-SA Standards Board approved IEEE Std 802.16.1 (*WirelessMAN-Advanced Air Interface for Broadband Wireless Access Systems*) as a new IEEE standard. IEEE Std 802.16.1 encompasses the WirelessMAN-Advanced air interface, with some minor improvements. On the same date, the Standards Board approved IEEE Std 802.16-2012 as a new revision of IEEE Std 802.16, which now excludes the WirelessMAN-Advanced air interface.

Accordingly, the material in § 2.2 reflects IEEE's structure of the WirelessMAN-Advanced air interface specification IEEE Std 802.16 which is composed of IEEE Std 802.16-2009, as amended, consecutively, by IEEE Std 802.16j-2009, IEEE Std 802.16h-2010, and IEEE Std 802.16m-2011.

<sup>17</sup> A “GCS” (Global Core Specification) is the set of specifications that defines a single RIT, an SRIT, or a RIT within an SRIT.

<sup>18</sup> Document [IMT-ADV/24\(Rev.1\)](#) is available on the ITU-R WP 5D webpage under the link “[IMT-Advanced documents](#)”.

The IMT-Advanced standards contained in this section are derived from the global core specification for *WirelessMAN-Advanced* contained at <http://ties.itu.int/u/itu-r/ede/rsg5/IMT-Advanced/GCS/M.2012-0/WirelessMAN-Advanced/>. The following notes apply to the sections below:

- 1) The identified relevant *Transposing Organizations* should make their reference material available from their website.
- 2) This information was supplied by the *Transposing Organizations* and relates to their own deliverables of the transposed global core specification.

### 2.2.1 Description of the global core specification and the transposed standards

IEEE Std 802.16 is composed of IEEE Std 802.16-2009, as amended, consecutively, by IEEE Std 802.16j-2009, IEEE Std 802.16h-2010, and IEEE Std 802.16m-2011. IEEE Std 802.16 is described in § 2.2.1.1.

In accordance with Clause 16.1.1 of IEEE Std 802.16, the *WirelessMAN-Advanced* GCS is specified in the clauses of IEEE Std 802.16 as indicated in Table 2.6. Anything in IEEE Std 802.16 that is not included in Table 2.6 is excluded from the *WirelessMAN-Advanced* GCS.

TABLE 2.6

Description of the *WirelessMAN-Advanced* GCS

IEEE Std 802.16 Clause and Subject	IEEE Std 802.16-2009	IEEE Std 802.16j-2009	IEEE Std 802.16h-2010	IEEE Std 802.16m-2011
Clause 1.4: Reference models	Base specification		Amended	Amended
Clause 2: Normative references	Base specification		Amended	Amended
Clause 3: Definitions	Base specification	Amended	Amended	Amended
Clause 4: Abbreviations and acronyms	Base specification	Amended	Amended	Amended
Clause 5.2: Packet convergence sublayer	Base specification			Amended
Clause 16: <i>WirelessMAN-Advanced</i> air interface				Base specification
Annex R: MAC control messages				Base specification
Annex S: Test vectors				Base specification
Annex T: Supported frequency bands				Base specification
Annex U: Radio specifications				Base specification
Annex V: Default capability class and parameters				Base specification

#### 2.2.1.1 IEEE Std 802.16

IEEE Std 802.16 is summarized here.

**IEEE Std 802.16: Standard for local and metropolitan area networks – Air interface for broadband wireless access systems**

This standard specifies the air interface, including the medium access control layer (MAC) and physical layer (PHY), of combined fixed and mobile point-to-multipoint broadband wireless access (BWA) systems providing multiple services. The MAC is structured to support multiple PHY specifications, each suited to a particular operational environment.

IEEE Std 802.16 is composed of IEEE Std 802.16-2009, as amended, consecutively, by IEEE Std 802.16j-2009, IEEE Std 802.16h-2010, and IEEE Std 802.16m-2011.

**2.2.1.1.1 IEEE Std 802.16-2009****Standard for local and metropolitan area networks – Part 16: Air interface for broadband wireless access systems**

This standard specifies the air interface, including the medium access control layer (MAC) and physical layer (PHY), of combined fixed and mobile point-to-multipoint broadband wireless access (BWA) systems providing multiple services. The MAC is structured to support multiple PHY specifications, each suited to a particular operational environment.

**2.2.1.1.2 IEEE Std 802.16j-2009****Standard for local and metropolitan area networks – Part 16: Air interface for broadband wireless access systems – Amendment 1: Multiple relay specification**

This amendment updates and expands IEEE Std 802.16-2009, specifying physical layer and medium access control layer enhancements to IEEE Std 802.16 for licensed bands to enable the operation of relay stations. Subscriber station specifications are not changed.

**2.2.1.1.3 IEEE Std 802.16h-2010****Standard for local and metropolitan area networks – Part 16: Air interface for broadband wireless access systems – Amendment 2: Improved coexistence mechanisms for license-exempt operation**

This amendment updates and expands IEEE Std 802.16, specifying improved mechanisms, as policies and medium access control enhancements, to enable coexistence among license-exempt systems and to facilitate the coexistence of such systems with primary users.

**2.2.1.1.4 IEEE Std 802.16m-2011****Standard for local and metropolitan area networks – Part 16: Air interface for broadband wireless access systems – Amendment 3: Advanced air interface**

This amendment specifies the *WirelessMAN-Advanced* air interface, an enhanced air interface designed to meet the requirements of the IMT-Advanced standardization activity conducted by the ITU-R. The amendment is based on the WirelessMAN-OFDMA specification of IEEE Std 802.16 and provides continuing support for WirelessMAN-OFDMA subscriber stations.

**2.2.1.2 Transposed standards****2.2.1.2.1 Transpositions: IEEE**

Reserved.

**2.2.1.2.2 Transpositions: ARIB**

	Base specification per IEEE Std 802.16-2009	Amendment per IEEE Std 802.16j-2009	Amendment per IEEE Std 802.16h-2010	Amendment per IEEE Std 802.16m-2011
<i>Transposing Organization</i>	ARIB	ARIB	ARIB	ARIB
<i>Document number</i>	ARIB STD-T105 Annex 1	ARIB STD-T105 Annex 2	ARIB STD-T105 Annex 3	ARIB STD-T105 Annex 4
<i>Version</i>	1.30	1.30	1.30	1.30
<i>Date</i>	18 December 2012	18 December 2012	18 December 2012	18 December 2012
Clause 1.4: Reference models	<a href="http://www.arib.or.jp/IMT-Advanced/WirelessMAN-Advanced.1.30/ARIB%20STD-T105%20Annex%201_IEEE%20Std%20802%2016-2009.pdf">http://www.arib.or.jp/IMT-Advanced/WirelessMAN-Advanced.1.30/ARIB%20STD-T105%20Annex%201_IEEE%20Std%20802%2016-2009.pdf</a> (Clause 1.4, ARIB transposition of IEEE Std 802.16-2009)	<i>Not applicable</i>	<a href="http://www.arib.or.jp/IMT-Advanced/WirelessMAN-Advanced.1.30/ARIB%20STD-T105%20Annex%203_IEEE%20Std%20802%2016h-2010.pdf">http://www.arib.or.jp/IMT-Advanced/WirelessMAN-Advanced.1.30/ARIB%20STD-T105%20Annex%203_IEEE%20Std%20802%2016h-2010.pdf</a> (Clause 1.4, ARIB transposition of IEEE Std 802.16h)	<a href="http://www.arib.or.jp/IMT-Advanced/WirelessMAN-Advanced.1.30/ARIB%20STD-T105%20Annex%204_IEEE%20Std%20802%2016m-2011.pdf">http://www.arib.or.jp/IMT-Advanced/WirelessMAN-Advanced.1.30/ARIB%20STD-T105%20Annex%204_IEEE%20Std%20802%2016m-2011.pdf</a> (Clause 1.4, ARIB transposition of IEEE Std 802.16m)
Clause 2: Normative references	<a href="http://www.arib.or.jp/IMT-Advanced/WirelessMAN-Advanced.1.30/ARIB%20STD-T105%20Annex%201_IEEE%20Std%20802%2016-2009.pdf">http://www.arib.or.jp/IMT-Advanced/WirelessMAN-Advanced.1.30/ARIB%20STD-T105%20Annex%201_IEEE%20Std%20802%2016-2009.pdf</a> (Clause 2, ARIB transposition of IEEE Std 802.16-2009)	<i>Not applicable</i>	<a href="http://www.arib.or.jp/IMT-Advanced/WirelessMAN-Advanced.1.30/ARIB%20STD-T105%20Annex%203_IEEE%20Std%20802%2016h-2010.pdf">http://www.arib.or.jp/IMT-Advanced/WirelessMAN-Advanced.1.30/ARIB%20STD-T105%20Annex%203_IEEE%20Std%20802%2016h-2010.pdf</a> (Clause 2, ARIB transposition of IEEE Std 802.16h)	<a href="http://www.arib.or.jp/IMT-Advanced/WirelessMAN-Advanced.1.30/ARIB%20STD-T105%20Annex%204_IEEE%20Std%20802%2016m-2011.pdf">http://www.arib.or.jp/IMT-Advanced/WirelessMAN-Advanced.1.30/ARIB%20STD-T105%20Annex%204_IEEE%20Std%20802%2016m-2011.pdf</a> (Clause 2, ARIB transposition of IEEE Std 802.16m)
Clause 3: Definitions	<a href="http://www.arib.or.jp/IMT-Advanced/WirelessMAN-Advanced.1.30/ARIB%20STD-T105%20Annex%201_IEEE%20Std%20802%2016-2009.pdf">http://www.arib.or.jp/IMT-Advanced/WirelessMAN-Advanced.1.30/ARIB%20STD-T105%20Annex%201_IEEE%20Std%20802%2016-2009.pdf</a> (Clause 3, ARIB transposition of IEEE Std 802.16-2009)	<a href="http://www.arib.or.jp/IMT-Advanced/WirelessMAN-Advanced.1.30/ARIB%20STD-T105%20Annex%202_IEEE%20Std%20802%2016j-2009.pdf">http://www.arib.or.jp/IMT-Advanced/WirelessMAN-Advanced.1.30/ARIB%20STD-T105%20Annex%202_IEEE%20Std%20802%2016j-2009.pdf</a> (Clause 3, ARIB transposition of IEEE Std 802.16j)	<a href="http://www.arib.or.jp/IMT-Advanced/WirelessMAN-Advanced.1.30/ARIB%20STD-T105%20Annex%203_IEEE%20Std%20802%2016h-2010.pdf">http://www.arib.or.jp/IMT-Advanced/WirelessMAN-Advanced.1.30/ARIB%20STD-T105%20Annex%203_IEEE%20Std%20802%2016h-2010.pdf</a> (Clause 3, ARIB transposition of IEEE Std 802.16h)	<a href="http://www.arib.or.jp/IMT-Advanced/WirelessMAN-Advanced.1.30/ARIB%20STD-T105%20Annex%204_IEEE%20Std%20802%2016m-2011.pdf">http://www.arib.or.jp/IMT-Advanced/WirelessMAN-Advanced.1.30/ARIB%20STD-T105%20Annex%204_IEEE%20Std%20802%2016m-2011.pdf</a> (Clause 3, ARIB transposition of IEEE Std 802.16m)
Clause 4: Abbreviations and acronyms	<a href="http://www.arib.or.jp/IMT-Advanced/WirelessMAN-Advanced.1.30/ARIB%20STD-T105%20Annex%201_IEEE%20Std%20802%2016-2009.pdf">http://www.arib.or.jp/IMT-Advanced/WirelessMAN-Advanced.1.30/ARIB%20STD-T105%20Annex%201_IEEE%20Std%20802%2016-2009.pdf</a> (Clause 4, ARIB transposition of IEEE Std 802.16-2009)	<a href="http://www.arib.or.jp/IMT-Advanced/WirelessMAN-Advanced.1.30/ARIB%20STD-T105%20Annex%202_IEEE%20Std%20802%2016j-2009.pdf">http://www.arib.or.jp/IMT-Advanced/WirelessMAN-Advanced.1.30/ARIB%20STD-T105%20Annex%202_IEEE%20Std%20802%2016j-2009.pdf</a> (Clause 4, ARIB transposition of IEEE Std 802.16j)	<a href="http://www.arib.or.jp/IMT-Advanced/WirelessMAN-Advanced.1.30/ARIB%20STD-T105%20Annex%203_IEEE%20Std%20802%2016h-2010.pdf">http://www.arib.or.jp/IMT-Advanced/WirelessMAN-Advanced.1.30/ARIB%20STD-T105%20Annex%203_IEEE%20Std%20802%2016h-2010.pdf</a> (Clause 4, ARIB transposition of IEEE Std 802.16h)	<a href="http://www.arib.or.jp/IMT-Advanced/WirelessMAN-Advanced.1.30/ARIB%20STD-T105%20Annex%204_IEEE%20Std%20802%2016m-2011.pdf">http://www.arib.or.jp/IMT-Advanced/WirelessMAN-Advanced.1.30/ARIB%20STD-T105%20Annex%204_IEEE%20Std%20802%2016m-2011.pdf</a> (Clause 4, ARIB transposition of IEEE Std 802.16m)
Clause 5.2: Packet convergence sublayer	<a href="http://www.arib.or.jp/IMT-Advanced/WirelessMAN-Advanced.1.30/ARIB%20STD-T105%20Annex%201_IEEE%20Std%20802%2016-2009.pdf">http://www.arib.or.jp/IMT-Advanced/WirelessMAN-Advanced.1.30/ARIB%20STD-T105%20Annex%201_IEEE%20Std%20802%2016-2009.pdf</a> (Clause 5.2, ARIB transposition of IEEE Std 802.16-2009)	<i>Not applicable</i>	<i>Not applicable</i>	<a href="http://www.arib.or.jp/IMT-Advanced/WirelessMAN-Advanced.1.30/ARIB%20STD-T105%20Annex%204_IEEE%20Std%20802%2016m-2011.pdf">http://www.arib.or.jp/IMT-Advanced/WirelessMAN-Advanced.1.30/ARIB%20STD-T105%20Annex%204_IEEE%20Std%20802%2016m-2011.pdf</a> (Clause 5.2, ARIB transposition of IEEE Std 802.16m)



	Base specification per IEEE Std 802.16-2009	Amendment per IEEE Std 802.16j-2009	Amendment per IEEE Std 802.16h-2010	Amendment per IEEE Std 802.16m-2011
Clause 16: WirelessMAN- Advanced air interface	<i>Not applicable</i>	<i>Not applicable</i>	<i>Not applicable</i>	<a href="http://www.arib.or.jp/IMT-Advanced/WirelessMAN-Advanced.1.30/ARIB%20STD-T105%20Annex%204_IEEE%20Std%20802%2016m-2011.pdf">http://www.arib.or.jp/IMT-Advanced/WirelessMAN-Advanced.1.30/ARIB%20STD-T105%20Annex%204_IEEE%20Std%20802%2016m-2011.pdf</a> (Clause 16, ARIB transposition of IEEE Std 802.16m)
Annex R: MAC control messages	<i>Not applicable</i>	<i>Not applicable</i>	<i>Not applicable</i>	<a href="http://www.arib.or.jp/IMT-Advanced/WirelessMAN-Advanced.1.30/ARIB%20STD-T105%20Annex%204_IEEE%20Std%20802%2016m-2011.pdf">http://www.arib.or.jp/IMT-Advanced/WirelessMAN-Advanced.1.30/ARIB%20STD-T105%20Annex%204_IEEE%20Std%20802%2016m-2011.pdf</a> (Annex R, ARIB transposition of IEEE Std 802.16m)
Annex S: Test vectors	<i>Not applicable</i>	<i>Not applicable</i>	<i>Not applicable</i>	<a href="http://www.arib.or.jp/IMT-Advanced/WirelessMAN-Advanced.1.30/ARIB%20STD-T105%20Annex%204_IEEE%20Std%20802%2016m-2011.pdf">http://www.arib.or.jp/IMT-Advanced/WirelessMAN-Advanced.1.30/ARIB%20STD-T105%20Annex%204_IEEE%20Std%20802%2016m-2011.pdf</a> (Annex S, ARIB transposition of IEEE Std 802.16m)
Annex T: Supported frequency bands	<i>Not applicable</i>	<i>Not applicable</i>	<i>Not applicable</i>	<a href="http://www.arib.or.jp/IMT-Advanced/WirelessMAN-Advanced.1.30/ARIB%20STD-T105%20Annex%204_IEEE%20Std%20802%2016m-2011.pdf">http://www.arib.or.jp/IMT-Advanced/WirelessMAN-Advanced.1.30/ARIB%20STD-T105%20Annex%204_IEEE%20Std%20802%2016m-2011.pdf</a> (Annex T, ARIB transposition of IEEE Std 802.16m)
Annex U: Radio specifications	<i>Not applicable</i>	<i>Not applicable</i>	<i>Not applicable</i>	<a href="http://www.arib.or.jp/IMT-Advanced/WirelessMAN-Advanced.1.30/ARIB%20STD-T105%20Annex%204_IEEE%20Std%20802%2016m-2011.pdf">http://www.arib.or.jp/IMT-Advanced/WirelessMAN-Advanced.1.30/ARIB%20STD-T105%20Annex%204_IEEE%20Std%20802%2016m-2011.pdf</a> (Annex U, ARIB transposition of IEEE Std 802.16m)
Annex V: Default capability class and parameters	<i>Not applicable</i>	<i>Not applicable</i>	<i>Not applicable</i>	<a href="http://www.arib.or.jp/IMT-Advanced/WirelessMAN-Advanced.1.30/ARIB%20STD-T105%20Annex%204_IEEE%20Std%20802%2016m-2011.pdf">http://www.arib.or.jp/IMT-Advanced/WirelessMAN-Advanced.1.30/ARIB%20STD-T105%20Annex%204_IEEE%20Std%20802%2016m-2011.pdf</a> (Annex V, ARIB transposition of IEEE Std 802.16m)

## 2.2.1.2.3 Transpositions: TTA

	Base specification per IEEE Std 802.16-2009	Amendment per IEEE Std 802.16j-2009	Amendment per IEEE Std 802.16h-2010	Amendment per IEEE Std 802.16m-2011
<i>Transposing Organization</i>	TTA	TTA	TTA	TTA
<i>Document number</i>	TTAE.IE-802.16-2009	TTAE.IE-802.16j	TTAE.IE-802.16h	TTAE.IE-802.16m
<i>Version</i>	1.0	1.0	1.0	1.0
<i>Date</i>	29 June 2011	29 June 2011	29 June 2011	29 June 2011
Clause 1.4: Reference models	<a href="http://www.tta.or.kr/data/tt asDown.jsp?where=14688 &amp;pk_num=TTAE.IE-802.16-2009">http://www.tta.or.kr/data/tt asDown.jsp?where=14688 &amp;pk_num=TTAE.IE-802.16-2009</a> (Clause 1.4, TTA transposition of IEEE Std 802.16-2009)	<i>Not applicable</i>	<a href="http://www.tta.or.kr/data/tt asDown.jsp?where=14688 &amp;pk_num=TTAE.IE-802.16h">http://www.tta.or.kr/data/tt asDown.jsp?where=14688 &amp;pk_num=TTAE.IE-802.16h</a> (Clause 1.4, TTA transposition of IEEE Std 802.16h)	<a href="http://www.tta.or.kr/data/tt asDown.jsp?where=14688 &amp;pk_num=TTAE.IE-802.16m">http://www.tta.or.kr/data/tt asDown.jsp?where=14688 &amp;pk_num=TTAE.IE-802.16m</a> (Clause 1.4, TTA transposition of IEEE Std 802.16m)
Clause 2: Normative references	<a href="http://www.tta.or.kr/data/tt asDown.jsp?where=14688 &amp;pk_num=TTAE.IE-802.16-2009">http://www.tta.or.kr/data/tt asDown.jsp?where=14688 &amp;pk_num=TTAE.IE-802.16-2009</a> (Clause 2, TTA transposition of IEEE Std 802.16-2009)	<i>Not applicable</i>	<a href="http://www.tta.or.kr/data/tt asDown.jsp?where=14688 &amp;pk_num=TTAE.IE-802.16h">http://www.tta.or.kr/data/tt asDown.jsp?where=14688 &amp;pk_num=TTAE.IE-802.16h</a> (Clause 2, TTA transposition of IEEE Std 802.16h)	<a href="http://www.tta.or.kr/data/tt asDown.jsp?where=14688 &amp;pk_num=TTAE.IE-802.16m">http://www.tta.or.kr/data/tt asDown.jsp?where=14688 &amp;pk_num=TTAE.IE-802.16m</a> (Clause 2, TTA transposition of IEEE Std 802.16m)
Clause 3: Definitions	<a href="http://www.tta.or.kr/data/tt asDown.jsp?where=14688 &amp;pk_num=TTAE.IE-802.16-2009">http://www.tta.or.kr/data/tt asDown.jsp?where=14688 &amp;pk_num=TTAE.IE-802.16-2009</a> (Clause 3, TTA transposition of IEEE Std 802.16-2009)	<a href="http://www.tta.or.kr/data/tt asDown.jsp?where=14688 &amp;pk_num=TTAE.IE-802.16j">http://www.tta.or.kr/data/tt asDown.jsp?where=14688 &amp;pk_num=TTAE.IE-802.16j</a> (Clause 3, TTA transposition of IEEE Std 802.16j)	<a href="http://www.tta.or.kr/data/tt asDown.jsp?where=14688 &amp;pk_num=TTAE.IE-802.16h">http://www.tta.or.kr/data/tt asDown.jsp?where=14688 &amp;pk_num=TTAE.IE-802.16h</a> (Clause 3, TTA transposition of IEEE Std 802.16h)	<a href="http://www.tta.or.kr/data/tt asDown.jsp?where=14688 &amp;pk_num=TTAE.IE-802.16m">http://www.tta.or.kr/data/tt asDown.jsp?where=14688 &amp;pk_num=TTAE.IE-802.16m</a> (Clause 3, TTA transposition of IEEE Std 802.16m)
Clause 4: Abbreviations and acronyms	<a href="http://www.tta.or.kr/data/tt asDown.jsp?where=14688 &amp;pk_num=TTAE.IE-802.16-2009">http://www.tta.or.kr/data/tt asDown.jsp?where=14688 &amp;pk_num=TTAE.IE-802.16-2009</a> (Clause 4, TTA transposition of IEEE Std 802.16-2009)	<a href="http://www.tta.or.kr/data/tt asDown.jsp?where=14688 &amp;pk_num=TTAE.IE-802.16j">http://www.tta.or.kr/data/tt asDown.jsp?where=14688 &amp;pk_num=TTAE.IE-802.16j</a> (Clause 4, TTA transposition of IEEE Std 802.16j)	<a href="http://www.tta.or.kr/data/tt asDown.jsp?where=14688 &amp;pk_num=TTAE.IE-802.16h">http://www.tta.or.kr/data/tt asDown.jsp?where=14688 &amp;pk_num=TTAE.IE-802.16h</a> (Clause 4, TTA transposition of IEEE Std 802.16h)	<a href="http://www.tta.or.kr/data/tt asDown.jsp?where=14688 &amp;pk_num=TTAE.IE-802.16m">http://www.tta.or.kr/data/tt asDown.jsp?where=14688 &amp;pk_num=TTAE.IE-802.16m</a> (Clause 4, TTA transposition of IEEE Std 802.16m)
Clause 5.2: Packet convergence sublayer	<a href="http://www.tta.or.kr/data/tt asDown.jsp?where=14688 &amp;pk_num=TTAE.IE-802.16-2009">http://www.tta.or.kr/data/tt asDown.jsp?where=14688 &amp;pk_num=TTAE.IE-802.16-2009</a> (Clause 5.2, TTA transposition of IEEE Std 802.16-2009)	<i>Not applicable</i>	<i>Not applicable</i>	<a href="http://www.tta.or.kr/data/tt asDown.jsp?where=14688 &amp;pk_num=TTAE.IE-802.16m">http://www.tta.or.kr/data/tt asDown.jsp?where=14688 &amp;pk_num=TTAE.IE-802.16m</a> (Clause 5.2, TTA transposition of IEEE Std 802.16m)
Clause 16: <i>WirelessMAN-Advanced</i> air interface	<i>Not applicable</i>	<i>Not applicable</i>	<i>Not applicable</i>	<a href="http://www.tta.or.kr/data/tt asDown.jsp?where=14688 &amp;pk_num=TTAE.IE-802.16m">http://www.tta.or.kr/data/tt asDown.jsp?where=14688 &amp;pk_num=TTAE.IE-802.16m</a> (Clause 16, TTA transposition of IEEE Std 802.16m)
Annex R: MAC control messages	<i>Not applicable</i>	<i>Not applicable</i>	<i>Not applicable</i>	<a href="http://www.tta.or.kr/data/tt asDown.jsp?where=14688 &amp;pk_num=TTAE.IE-802.16m">http://www.tta.or.kr/data/tt asDown.jsp?where=14688 &amp;pk_num=TTAE.IE-802.16m</a> (Annex R, TTA transposition of IEEE Std 802.16m)

	Base specification per IEEE Std 802.16-2009	Amendment per IEEE Std 802.16j-2009	Amendment per IEEE Std 802.16h-2010	Amendment per IEEE Std 802.16m-2011
Annex S: Test vectors	<i>Not applicable</i>	<i>Not applicable</i>	<i>Not applicable</i>	<a href="http://www.tta.or.kr/data/tt asDown.jsp?where=14688 &amp;pk_num=TTAE.IE-802.16m">http://www.tta.or.kr/data/tt asDown.jsp?where=14688 &amp;pk_num=TTAE.IE-802.16m</a> (Annex S, TTA transposition of IEEE Std 802.16m)
Annex T: Supported frequency bands	<i>Not applicable</i>	<i>Not applicable</i>	<i>Not applicable</i>	<a href="http://www.tta.or.kr/data/tt asDown.jsp?where=14688 &amp;pk_num=TTAE.IE-802.16m">http://www.tta.or.kr/data/tt asDown.jsp?where=14688 &amp;pk_num=TTAE.IE-802.16m</a> (Annex T, TTA transposition of IEEE Std 802.16m)
Annex U: Radio specifications	<i>Not applicable</i>	<i>Not applicable</i>	<i>Not applicable</i>	<a href="http://www.tta.or.kr/data/tt asDown.jsp?where=14688 &amp;pk_num=TTAE.IE-802.16m">http://www.tta.or.kr/data/tt asDown.jsp?where=14688 &amp;pk_num=TTAE.IE-802.16m</a> (Annex U, TTA transposition of IEEE Std 802.16m)
Annex V: Default capability class and parameters	<i>Not applicable</i>	<i>Not applicable</i>	<i>Not applicable</i>	<a href="http://www.tta.or.kr/data/tt asDown.jsp?where=14688 &amp;pk_num=TTAE.IE-802.16m">http://www.tta.or.kr/data/tt asDown.jsp?where=14688 &amp;pk_num=TTAE.IE-802.16m</a> (Annex V, TTA transposition of IEEE Std 802.16m)

#### 2.2.1.2.4 Transpositions: WiMAX Forum

	Base specification per IEEE Std 802.16-2009	Amendment per IEEE Std 802.16j-2009	Amendment per IEEE Std 802.16h-2010	Amendment per IEEE Std 802.16m-2011
<i>Transposing Organization</i>	WIMAX FORUM	WIMAX FORUM	WIMAX FORUM	WIMAX FORUM
<i>Document number</i>	T28-001-R020v01, WIMAX FORUM transposition of IEEE Std 802.16-2009	T28-001-R020v01, WIMAX FORUM transposition of IEEE Std 802.16j	T28-001-R020v01, WIMAX FORUM transposition of IEEE Std 802.16h	T28-001-R020v01, WIMAX FORUM transposition of IEEE Std 802.16m
<i>Version</i>	V01	V01	V01	V01
<i>Date</i>	20 September 2011	20 September 2011	20 September 2011	20 September 2011
Clause 1.4: Reference models	<a href="http://www.wimaxforum.org/files/WMF-IMT-Advanced-Spec-T28-001-R020v01.pdf">http://www.wimaxforum.org/files/WMF-IMT-Advanced-Spec-T28-001-R020v01.pdf</a> (Clause 1.4, WIMAX FORUM transposition of IEEE Std 802.16-2009)	<i>Not applicable</i>	<a href="http://www.wimaxforum.org/files/WMF-IMT-Advanced-Spec-T28-001-R020v01.pdf">http://www.wimaxforum.org/files/WMF-IMT-Advanced-Spec-T28-001-R020v01.pdf</a> (Clause 1.4, WIMAX FORUM transposition of IEEE Std 802.16h)	<a href="http://www.wimaxforum.org/files/WMF-IMT-Advanced-Spec-T28-001-R020v01.pdf">http://www.wimaxforum.org/files/WMF-IMT-Advanced-Spec-T28-001-R020v01.pdf</a> (Clause 1.4, WIMAX FORUM transposition of IEEE Std 802.16m)
Clause 2: Normative references	<a href="http://www.wimaxforum.org/files/WMF-IMT-Advanced-Spec-T28-001-R020v01.pdf">http://www.wimaxforum.org/files/WMF-IMT-Advanced-Spec-T28-001-R020v01.pdf</a> (Clause 2, WIMAX FORUM transposition of IEEE Std 802.16-2009)	<i>Not applicable</i>	<a href="http://www.wimaxforum.org/files/WMF-IMT-Advanced-Spec-T28-001-R020v01.pdf">http://www.wimaxforum.org/files/WMF-IMT-Advanced-Spec-T28-001-R020v01.pdf</a> (Clause 2, WIMAX FORUM transposition of IEEE Std 802.16h)	<a href="http://www.wimaxforum.org/files/WMF-IMT-Advanced-Spec-T28-001-R020v01.pdf">http://www.wimaxforum.org/files/WMF-IMT-Advanced-Spec-T28-001-R020v01.pdf</a> (Clause 2, WIMAX FORUM transposition of IEEE Std 802.16m)

	Base specification per IEEE Std 802.16-2009	Amendment per IEEE Std 802.16j-2009	Amendment per IEEE Std 802.16h-2010	Amendment per IEEE Std 802.16m-2011
Clause 3: Definitions	<a href="http://www.wimaxforum.org/files/WMF-IMT-Advanced-Spec-T28-001-R020v01.pdf">http://www.wimaxforum.org/files/WMF-IMT-Advanced-Spec-T28-001-R020v01.pdf</a> (Clause 3, WIMAX FORUM transposition of IEEE Std 802.16-2009)	<a href="http://www.wimaxforum.org/files/WMF-IMT-Advanced-Spec-T28-001-R020v01.pdf">http://www.wimaxforum.org/files/WMF-IMT-Advanced-Spec-T28-001-R020v01.pdf</a> (Clause 3, WIMAX FORUM transposition of IEEE Std 802.16j)	<a href="http://www.wimaxforum.org/files/WMF-IMT-Advanced-Spec-T28-001-R020v01.pdf">http://www.wimaxforum.org/files/WMF-IMT-Advanced-Spec-T28-001-R020v01.pdf</a> (Clause 3, WIMAX FORUM transposition of IEEE Std 802.16h)	<a href="http://www.wimaxforum.org/files/WMF-IMT-Advanced-Spec-T28-001-R020v01.pdf">http://www.wimaxforum.org/files/WMF-IMT-Advanced-Spec-T28-001-R020v01.pdf</a> (Clause 3, WIMAX FORUM transposition of IEEE Std 802.16m)
Clause 4: Abbreviations and acronyms	<a href="http://www.wimaxforum.org/files/WMF-IMT-Advanced-Spec-T28-001-R020v01.pdf">http://www.wimaxforum.org/files/WMF-IMT-Advanced-Spec-T28-001-R020v01.pdf</a> (Clause 4, WIMAX FORUM transposition of IEEE Std 802.16-2009)	<a href="http://www.wimaxforum.org/files/WMF-IMT-Advanced-Spec-T28-001-R020v01.pdf">http://www.wimaxforum.org/files/WMF-IMT-Advanced-Spec-T28-001-R020v01.pdf</a> (Clause 4, WIMAX FORUM transposition of IEEE Std 802.16j)	<a href="http://www.wimaxforum.org/files/WMF-IMT-Advanced-Spec-T28-001-R020v01.pdf">http://www.wimaxforum.org/files/WMF-IMT-Advanced-Spec-T28-001-R020v01.pdf</a> (Clause 4, WIMAX FORUM transposition of IEEE Std 802.16h)	<a href="http://www.wimaxforum.org/files/WMF-IMT-Advanced-Spec-T28-001-R020v01.pdf">http://www.wimaxforum.org/files/WMF-IMT-Advanced-Spec-T28-001-R020v01.pdf</a> (Clause 4, WIMAX FORUM transposition of IEEE Std 802.16m)
Clause 5.2: Packet convergence sublayer	<a href="http://www.wimaxforum.org/files/WMF-IMT-Advanced-Spec-T28-001-R020v01.pdf">http://www.wimaxforum.org/files/WMF-IMT-Advanced-Spec-T28-001-R020v01.pdf</a> (Clause 5.2, WIMAX FORUM transposition of IEEE Std 802.16-2009)	<i>Not applicable</i>	<i>Not applicable</i>	<a href="http://www.wimaxforum.org/files/WMF-IMT-Advanced-Spec-T28-001-R020v01.pdf">http://www.wimaxforum.org/files/WMF-IMT-Advanced-Spec-T28-001-R020v01.pdf</a> (Clause 5.2, WIMAX FORUM transposition of IEEE Std 802.16m)
Clause 16: <i>WirelessMAN- Advanced</i> air interface	<i>Not applicable</i>	<i>Not applicable</i>	<i>Not applicable</i>	<a href="http://www.wimaxforum.org/files/WMF-IMT-Advanced-Spec-T28-001-R020v01.pdf">http://www.wimaxforum.org/files/WMF-IMT-Advanced-Spec-T28-001-R020v01.pdf</a> (Clause 16, WIMAX FORUM transposition of IEEE Std 802.16m)
Annex R: MAC control messages	<i>Not applicable</i>	<i>Not applicable</i>	<i>Not applicable</i>	<a href="http://www.wimaxforum.org/files/WMF-IMT-Advanced-Spec-T28-001-R020v01.pdf">http://www.wimaxforum.org/files/WMF-IMT-Advanced-Spec-T28-001-R020v01.pdf</a> (Annex R, WIMAX FORUM transposition of IEEE Std 802.16m)
Annex S: Test vectors	<i>Not applicable</i>	<i>Not applicable</i>	<i>Not applicable</i>	<a href="http://www.wimaxforum.org/files/WMF-IMT-Advanced-Spec-T28-001-R020v01.pdf">http://www.wimaxforum.org/files/WMF-IMT-Advanced-Spec-T28-001-R020v01.pdf</a> (Annex S, WIMAX FORUM transposition of IEEE Std 802.16m)
Annex T: Supported frequency bands	<i>Not applicable</i>	<i>Not applicable</i>	<i>Not applicable</i>	<a href="http://www.wimaxforum.org/files/WMF-IMT-Advanced-Spec-T28-001-R020v01.pdf">http://www.wimaxforum.org/files/WMF-IMT-Advanced-Spec-T28-001-R020v01.pdf</a> (Annex T, WIMAX FORUM transposition of IEEE Std 802.16m)
Annex U: Radio specifications	<i>Not applicable</i>	<i>Not applicable</i>	<i>Not applicable</i>	<a href="http://www.wimaxforum.org/files/WMF-IMT-Advanced-Spec-T28-001-R020v01.pdf">http://www.wimaxforum.org/files/WMF-IMT-Advanced-Spec-T28-001-R020v01.pdf</a> (Annex U, WIMAX FORUM transposition of IEEE Std 802.16m)

	Base specification per IEEE Std 802.16-2009	Amendment per IEEE Std 802.16j-2009	Amendment per IEEE Std 802.16h-2010	Amendment per IEEE Std 802.16m-2011
Annex V: Default capability class and parameters	<i>Not applicable</i>	<i>Not applicable</i>	<i>Not applicable</i>	<a href="http://www.wimaxforum.org/files/WMF-IMT-Advanced-Spec-T28-001-R020v01.pdf">http://www.wimaxforum.org/files/WMF-IMT-Advanced-Spec-T28-001-R020v01.pdf</a> (Annex V, WIMAX FORUM transposition of IEEE Std 802.16m)

### 2.3 Detailed specification of the radio interface technology<sup>19</sup>

The material in § 2.3 reflects the structure of the IEEE specifications subsequent to the IEEE revising the structure of the relevant IEEE specifications related to *WirelessMAN-Advanced* on 8 June 2013 beginning with Revision 1 of Recommendation ITU-R M.2012 (2014).

Detailed specifications described in this Annex are developed around a “Global Core Specification” (GCS)<sup>20</sup>, which is related to externally developed materials incorporated by specific references for a specific technology. The process and use of the GCS, references, and related notifications and certifications are found as Document IMT-ADV/24(Rev.2)<sup>21</sup>.

The IMT-Advanced standards contained in this section are derived from the global core specification for *WirelessMAN-Advanced* contained at <http://ties.itu.int/u/itu-r/ede/rsg5/IMT-Advanced/GCS/M.2012-1/WirelessMAN-Advanced/>. The following notes apply to the sections below:

- 1) The identified relevant *Transposing Organizations* should make their reference material available from their website.
- 2) This information was supplied by the *Transposing Organizations* and relates to their own deliverables of the transposed global core specification.

<sup>19</sup> On 8 June 2012, the IEEE-SA Standards Board approved IEEE Std 802.16.1 (*WirelessMAN-Advanced Air Interface for Broadband Wireless Access Systems*) as a new IEEE standard. IEEE Std 802.16.1 encompasses the WirelessMAN-Advanced air interface, with some minor improvements. On the same date, the Standards Board approved IEEE Std 802.16-2012 as a new revision of IEEE Std 802.16, which now excludes the WirelessMAN-Advanced air interface.

Accordingly, the material in § 2.3 reflects IEEE’s transfer of the WirelessMAN-Advanced air interface specification to IEEE Std 802.16.1. The WirelessMAN-Advanced GCS for § 2.3 includes IEEE Std 802.16.1 but not IEEE Std 802.16.

IEEE has further enhanced IEEE Std 802.16.1 with two amendments:

- IEEE Std 802.16.1a: WirelessMAN-Advanced Air Interface for Broadband Wireless Access Systems – Amendment: Higher Reliability Networks.
- IEEE Std 802.16.1b: WirelessMAN-Advanced Air Interface for Broadband Wireless Access Systems – Amendment: Enhancements to Support Machine-to-Machine Applications.

The content of these two standards is also included in § 2.3.

<sup>20</sup> A “GCS” (Global Core Specification) is the set of specifications that defines a single RIT, an SRIT, or a RIT within an SRIT.

<sup>21</sup> Document [IMT-ADV/24\(Rev.2\)](http://www.itu.int/ITU-R/workinggroups/05/IMT-Advanced/documents/) is available on the ITU-R WP 5D webpage under the link “[IMT-Advanced documents](http://www.itu.int/ITU-R/workinggroups/05/IMT-Advanced/documents/)”.

### 2.3.1 Description of the global core specification and the transposed standards

IEEE Std 802.16.1 is composed of IEEE Std 802.16.1-2012, as amended, consecutively, by IEEE Std 802.16.1b-2012 and IEEE Std 802.16.1a-2013. IEEE Std 802.16.1 is described in § 2.3.1.1.

TABLE 2.7

#### Description of the *WirelessMAN-Advanced* GCS

IEEE Std 802.16.1 Clause and Subject	IEEE Std 802.16.1-2012	IEEE Std 802.16.1b-2012	IEEE Std 802.16.1a-2013
Clause 1: Overview	Base specification	Amended	Amended
Clause 2: Normative references	Base specification		
Clause 3: Definitions	Base specification	Amended	Amended
Clause 4: Abbreviations and acronyms	Base specification		Amended
Clause 5: Service-Specific Convergence Sublayer	Base specification		Amended
Clause 6: <i>WirelessMAN-Advanced</i> Air Interface	Base specification	Amended	Amended
Annex A: Bibliography	Base specification		
Annex B: Control Messages	Base specification	Amended	Amended
Annex C: Test Vectors	Base specification		
Annex D: Supported frequency bands	Base specification		
Annex E: Radio specifications	Base specification		
Annex F: Default capability class and parameters	Base specification		

#### 2.3.1.1 IEEE Std 802.16.1

IEEE Std 802.16.1 is summarized here.

#### **IEEE Std 802.16.1: IEEE Standard for WirelessMAN-Advanced Air Interface for Broadband Wireless Access Systems**

This standard specifies the WirelessMAN-Advanced Air Interface, including the medium access control layer (MAC) and physical layer (PHY), of a broadband wireless access (BWA) system supporting multiple services

IEEE Std 802.16.1 is composed of IEEE Std 802.16.1-2012, as amended, consecutively, by IEEE Std 802.16.1b-2012 and IEEE Std 802.16.1a-2013.

##### 2.3.1.1.1 IEEE Std 802.16.1-2012

#### **IEEE Standard for WirelessMAN-Advanced Air Interface for Broadband Wireless Access Systems**

This standard specifies the WirelessMAN-Advanced Air Interface, including the medium access control layer (MAC) and physical layer (PHY), of a broadband wireless access (BWA) system supporting multiple services.

**2.3.1.1.2 IEEE Std 802.16.1b-2012****IEEE Standard for WirelessMAN-Advanced Air Interface for Broadband Wireless Access Systems – Amendment 1: Enhancements to Support Machine-to-Machine Applications**

This amendment specifies enhancements to the WirelessMAN-Advanced Air Interface. The enhancements provide improved support for machine-to-machine applications. As of the approval date, the applicable version of IEEE Std 802.16.1 is IEEE Std 802.16.1-2012, as amended by IEEE 802.16.1b-2012.

**2.3.1.1.3 IEEE Std 802.16.1a-2013****IEEE Standard for WirelessMAN-Advanced Air Interface for Broadband Wireless Access Systems – Amendment 2: Higher Reliability Networks**

This amendment updates and expands IEEE Std 802.16.1, specifying enhanced mechanisms to support Higher Reliability Networks. As of the publication date, the current version of IEEE Std 802.16.1 is IEEE Std 802.16.1-2012, as amended by IEEE Std 802.16.1b-2012 and IEEE Std 802.16.1a-2013.

**2.3.1.2 Transposed standards****2.3.1.2.1 Transpositions: IEEE**

	<b>Base standard per IEEE Std 802.16.1-2012</b>	<b>Amendment per IEEE Std 802.16.1b-2012</b>	<b>Amendment per IEEE Std 802.16.1a-2013</b>
<i>Transposing Organization</i>	IEEE	IEEE	IEEE
<i>Document Number</i>	IEEE Std 802.16.1-2012	IEEE Std 802.16.1b-2012	IEEE Std 802.16.1a-2013
<i>Version</i>	2012	2012	2013
<i>Issued Date</i>	8 June 2012	30 August 2012	6 March 2013
<i>Document</i>	IEEE transposition of IEEE Std 802.16.1-2012	IEEE transposition of IEEE Std 802.16.1b-2012	IEEE transposition of IEEE Std 802.16.1a-2013

**2.3.1.2.2 Transpositions: ARIB**

Reserved.

**2.3.1.2.3 Transpositions: TTA**

	<b>Base standard per IEEE Std 802.16.1-2012</b>	<b>Amendment per IEEE Std 802.16.1b-2012</b>	<b>Amendment per IEEE Std 802.16.1a-2013</b>
<i>Transposing Organization</i>	TTA	TTA	TTA
<i>Document Number</i>	TTAE.IE-802.16.1-2012	TTAE.IE-802.16.1b-2012	<i>Not applicable</i>
<i>Version</i>	1.0	1.0	<i>Not applicable</i>
<i>Issued Date</i>	21 December 2012	26 June 2013	<i>Not applicable</i>
<i>Document</i>	<a href="http://committee.tta.or.kr/include/Download.jsp?file">http://committee.tta.or.kr/include/Download.jsp?file</a>	<a href="http://committee.tta.or.kr/include/Download.jsp?file">http://committee.tta.or.kr/include/Download.jsp?file</a>	<i>Not applicable</i>

	<a href="#">name=stnfile/TTAE_[1].IE-802.16.1-2012.pdf</a> (TTA transposition of IEEE Std 802.16.1-2012)	<a href="#">name=stnfile/TTAE.IE-802.16.1b-2012.zip</a> (TTA transposition of IEEE Std 802.16.1b-2012)	
--	---	---	--

#### 2.3.1.2.4 Transpositions: WiMAX Forum

Reserved.

#### 2.3.1.2.5 Transpositions: ITRI

	<b>Base standard per IEEE Std 802.16.1-2012</b>	<b>Amendment per IEEE Std 802.16.1b-2012</b>	<b>Amendment per IEEE Std 802.16.1a-2013</b>
<i>Transposing Organization</i>	ITRI	ITRI	ITRI
<i>Document Number</i>	ITRI-2013-Std-001	ITRI-2013-Std-001	ITRI-2013-Std-001
<i>Version</i>	2013	2013	2013
<i>Issued Date</i>	6 September 2013	6 September 2013	6 September 2013
<i>Document</i>	<a href="http://std-share.itri.org.tw/Content/Files/Stdlink/ITRI-BWA-001.pdf">http://std-share.itri.org.tw/Content/Files/Stdlink/ITRI-BWA-001.pdf</a>	<a href="http://std-share.itri.org.tw/Content/Files/Stdlink/ITRI-BWA-001.pdf">http://std-share.itri.org.tw/Content/Files/Stdlink/ITRI-BWA-001.pdf</a>	<a href="http://std-share.itri.org.tw/Content/Files/Stdlink/ITRI-BWA-001.pdf">http://std-share.itri.org.tw/Content/Files/Stdlink/ITRI-BWA-001.pdf</a>